

Continental 
The Future in Motion



Industrial Hose

2016 Product Catalog

www.contitech.us

ContiTech

Everything You Need

Flexsteel® 250 EPDM-20 steam hose

With a maximum operating pressure of 250 psi and temperature range of -40°F to 450°F (-40°C to 232°C), Flexsteel 250 steam hose exceeds the RMA safety standard and makes steam operations more secure and user-friendly.



Extremeflex™ Petroleum Transfer

An extremely flexible and lightweight hose for use in tank truck and drilling operation to transfer diesel, ethanol, gasoline, oil and petroleum-based products. Corrugated construction for lower drag coefficient and superior abrasion resistance.



Survivor® compound

Featuring 2X the life on average*, Survivor is one of the toughest cover compounds used on ContiTech conveyor belts. It is able to withstand serious abuse and still last longer.

OILSAND

Excellent oil resistance plus abrasion resistance available as made to order with Hydrovator and other material handling hoses.



READY 2 GO

Ready 2 Go coupled hose assemblies

The R2G system has pre-coupled hose assemblies ready for delivery, so you wait less. And since it is available in seven different hose categories, you can rely on us to have the hose you need, when you need it.

*Based on lab results from DIN test with non-rotating head versus abrasion-resistant SBR compounds. Service life may vary depending on application conditions.



to Succeed

LT fuel oil delivery hose

Perfect for transfer and delivery of fuel oil and petroleum products for home delivery, commercial and industrial service, this hose is designed to stay flexible in cold temperatures and provide superior oil resistance.



Insta-Lock™ coupling hose systems

Insta-Lock coupling hose systems are designed with a cam & groove crimped coupling solution, developed to facilitate the use of crimped sleeves on industrial hoses by ContiTech. Available in aluminum, 316 SS and brass. Part A, B, C, D, E, F, dust plug, dust cap and jump sizes to meet your application needs.



Flexsteel® Futura™ low perm dispensing hose

Get superior, long-lasting service with multi-fuel capability. This hose is designed for use at filling stations to reduce permeation rates to 10 g/m²/day and improve air quality and emissions.



Crimping tools

We also offer a variety of crimping tools for on-site, in-vehicle and stationary applications. Available from 1/4" up to 12" ID to meet your industrial hose assembly needs.



Industry-Leading Technology,

Continental ContiTech specializes in the engineering and distribution of innovative, reliable and high-performance industrial hose products for a vast array of industrial, commercial and residential applications.

Air & Multi-Purpose General purpose



Industrial hoses with a wide range of multi-purpose applications from 1/4" to 2", -65°F to 275°F (-54°C to 135°C), compressors to jackhammers, 25 psi to 1000 psi.

- › Arctic Ortac®
- › Arctic Ortac® Plus
- › Braidair™
- › F5™ Air Hose
- › Flexsteel® Service Station Air
- › Frontier™ 200
- › Frontier™ 250
- › Frontier™ 300
- › Gorilla®
- › Jackhammer 200
- › Jackhammer 300
- › MIL A-A-59565
- › Nitrogen
- › Ortac® 250
- › Ortac® 300
- › Ortac® 400
- › Pliovic® FG (FDA-3A)
- › Pliovic® GS
- › Pliovic® Plus 250
- › Service Station Air
- › Variflex™ 200
- › Variflex™ 300

Heavy duty



Industrial hoses with a wide range of multi-purpose applications from 1/4" to 2", -65°F to 275°F (-54°C to 135°C), compressors to jackhammers, 25 psi to 1000 psi.

- › Crimped Jackhammer Assembly
- › Plicord® Air Green 400

- › Plicord® Super Rock Drill
- › Prospector™ Air
- › Prospector™ Plus Air
- › Steel Air
- › Super Ortac®

Push-on



Specifically designed for the rigors of robotic, automated and pressurized applications. Temperature ranges from -40°F to 200°F (-40°C to 93°C), textile reinforcement, 3/16" through 1" ID.

- › FLEXAGrip
- › Insta-Grip™ 250
- › Insta-Grip™ 300
- › Insta-Grip™ HT
- › Insta-Grip™ TC

Chemical Transfer



Engineered for reliable transfer of industrial chemicals and other solutions. Multiple cover color options, -40°F to 300°F (-40°C to 149°C), up to 200 psi WP.

- › Blue Flexwing®
- › Brown Flexwing®
- › Chem One™
- › DEF Transfer Hose
- › Fabchem™
- › Green XLPE
- › Hi-Per®
- › Orange Flexwing®
- › Plicord ExtremeFlex™ Brown
- › Plicord ExtremeFlex™ Purple
- › Purple Flexwing®
- › Viper®

Cleaning Equipment



Engineered for reliable transfer of industrial chemicals and other solutions. Multiple cover color options, -40°F to 300°F (-40°C to 149°C), up to 200 psi WP.

- › Fortress® 300
- › Fortress® 1000
- › Fortress® 3000
- › Galvanator® 3000
- › Gauntlet® 1500
- › Gauntlet® 3000
- › Gauntlet® 4500
- › Hydrocarbon Drain Hose
- › Neptune™ 1500
- › Neptune™ 3000
- › Neptune™ 4001-R
- › Neptune™ 4500
- › Neptune™ 6000
- › SpiraFlow®
- › Whitewater®

Food Food transfer

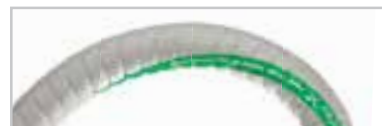

Designed to handle nearly every type of dry bulk food material or liquids in plant and truck applications. With temperature ranges from -40°F to 230°F (-40°C to 110°C), FDA/3-A/USDA approvals.

- › Exstatic®
- › ExtremeFlex™ Beverage
- › ExtremeFlex™ Beverage w/EZ Clean Cover
- › Gray Flextra® LT
- › Harvest®
- › Nutriflex® Suction & Discharge
- › Nutriflex® Static Wire

Reliability and Performance

- › Nutriflo® Suction & Discharge
- › Plicord® Blue Flour
- › Plicord® Brewline
- › Plicord® Clearwater
- › Plicord® ExtremeFlex™ Food Grade
- › Plicord® Gray Food
- › Plicord® Wineline
- › Pliovic® FG (FDA-3A)
- › Potable Water
- › Pyroflex® III Hot Air
- › Spirathane™ PT
- › Velocity Beverage Transfer
- › Vintner™
- › White Flexwing®

Food washdown



Designed for use in pressure washers and cleanup in food processing plants. Microban® protection available. Working pressures up to 1000 psi. Microban is a registered trademark of Microban U.S.A.

- › Blue Fortress® 300
- › Fortress® 300
- › Fortress® 1000
- › Fortress® 3000
- › Gauntlet® 1500
- › Plicord® Washdown
- › Sani-Wash™ 300
- › Sani-Wash™ Plus 300
- › Super Sani-Wash™ 300

Marine



For multiple maritime applications. USCG and SAE approvals. From 1/4" up to 10" ID available.

- › Flexshield™ Marine Barrier Hose
- SAE J1527 USCG Type A1-15 / ISO 7840
- › Marine Fuel Feed Vent Hose
- USCG/SAE J1527 Type A2
- › USCG/SAE J1527 Type B2
- › Marine Fuel Line
- USCG/SAE J1527 & ISO 7840 Type A1
- › Plicord® Hardwall Wet Exhaust
- › Plicord® SAE J1527 Type A2 (fuel fill)
- › Plicord® Softwall Wet Exhaust

Material Handling Abrasives



For industrial blasting, suction and high-pressure applications. Temperature ranges from -40°F to 190°F (-40°C to 88°C) and from 1/2" to 18" ID.

- › Artrac®
- › Arvac™ SW
- › Blucor™
- › Blucor™ Couplings
- › Diversiflex®
- › Diversipipe® 75
- › Diversipipe® 150
- › Flexible Downspout
- › Nutriflex® Static Wire
- › Plicord® Blast (2 ply & 4 ply)
- › Plicord® Dredge Sleeve
- › Plicord® Hydrovator
- › Plicord® RVC
- › Plicord® Sand Suction
- › Plicord® XF Blast (2 ply & 4 ply)
- › Sandblast Deadman
- › Spiraflex® Air Seeder Hose
- › Spirathane™ HD
- › Spirathane™ LD
- › Spirathane™ PT

Bulk transfer



Designed for conveying air and materials in tank truck and plant services up to 150 psi with temperature ranges from -40°F to 400°F (-40°C to 204°C).

- › Black Softwall
- › FDA Hot Air
- › Flextra® Dry Material
- › Plicord® Torridair™ Hot Air Blower
- › Pyroflex® II Hot Air
- › Pyroflex® III Hot Air
- › Spiraflex® Mulch Blower
- › Tan Flextra®
- › Tan Flexwing®
- › Tan Softwall

Cement & concrete



Used to handle the transfer of sand, cement and other materials for construction industry applications. With textile or wire reinforcements and up to 1200 psi.

- › Allcrete® Textile
(plaster, grout & concrete)
- › Allcrete® Wire
- › PGC Placement Textile
- › Plicord® Auger Arc Piling
- › Plicord® Gunite (tan)



Mining



Designed for a variety of applications in above-ground & underground mining application. Temperature ranges from -40°F to 200°F (-40°C to 93°C) and working pressures up to 1000 psi.

- › Brigade® Mine
- › Flextra® Rock Dust
- › M&P Mine Conduit
- › Mine Spray
- › Plicord® Ammonium Nitrate HD
- › Plicord® Ammonium Nitrate Pellet
- › Plicord® Mine Conduit
- › Spiraflex® Cable Guard
- › Spiraflex® Red
- › Spiraflex® Rock Dust
- › Spiraflex® Yellow (Spiraflex 2700)

Petroleum Aircraft fueling



For fueling or defueling of public and private aircraft. API/NFPA/EN standards, from 1/4" to 4" ID.

- › Advantage™
- › Deadman Aircraft Refueling
- › Jet Ranger™
- › Platinum JAC Riser
- › Refueling Sensing
- › Wingcraft™

Petroleum dispensing



Heavy-duty hoses designed to dispense a wide range of fuels. Available in 5/8" to 1 1/4" ID.

- › Aggie Gas™
- › BC Cold Flex

- › BC Gasoline
- › BC Marina
- › DEF Dispensing Hose
- › Flexsteel® Futura® Ethan-ALL
- › Flexsteel® Futura®
- › Flexsteel® Futura® Low Perm
- › Flexsteel® Futura® HVR
- › Flexsteel® Futura® Vapor Assist
- › Maxim™ Premier
- › Maxim™ Premier Plus
- › Pacer™

Petroleum dock hose



For transfer of petroleum-based products between docks and ships. From 3" to 12" ID and temperature ranges from -25°F to 350°F (-32°C to 177°C).

- › Flexdock® 225
- › Flexdock® 300
- › Hot Tar & Asphalt Rough & Smooth Bore
- › Plicord® Dock Hose
- › Smooth Bore Dock 200
- › Smooth Bore Dock 300
- › Tanker Barge Discharge
- › Vapor Recovery Dock

Petroleum transfer



Designed for the transfer and delivery of fuel, oil and petroleum products for home delivery, commercial and industrial service applications. Working pressures up to 300 psi.

- › Arctic® ExtremeFlex™
- › Arctic Flexwing
- › Blue Low Temp Fuel Oil Delivery
- › ExtremeFlex Petroleum
- › Flexwing® Oilfield
- › Flexwing Petroleum
- › Flexwing® VersaFuel
- › Fuel Discharge
- › Hydrocarbon Drain Hose



- › Infinity™
- › Infinity™ HD
- › LW Arctic Tank Truck
- › Paladin®
- › Plicord® Oilfield Frac
- › Plicord® Super Black Flexwing
- › Pyroflex® Hot Tar & Asphalt II
- › Pyroflex® Hot Tar Wand
- › Red Flextra® 100 543-267
- › Red Flextra® 150 543-266
- › Redwing Fuel Oil
- › Spiraflex® Polyurethane Vapor Recovery

Spray Hose



All-purpose hoses designed for a variety of paint and agricultural spray applications. Working pressures up to 800 psi.

- › Mine Spray
- › NR Spray
- › Pliovic® Ag Spray (1800 & 2400)

Steam Hose



Designed for industrial applications requiring the transfer of steam. Flexsteel® available with crimped fitting solutions.

- › Flexsteel® 250 CB Extreme
- › Flexsteel® 250 CB Steam
- › Flexsteel® 250 Steam
- › Flexsteel® 250 EPDM-20
- › Heavy Duty Steam Pile Driver
- › Hydrocarbon Drain Hose
- › MIL-DTL-29210E
- › Plicord® 250 Steam

Vacuum Hose



For a wide variety of applications including leaf collection, manhole blowers and exhaust fumes. Available in 1½" to 8" ID.

- › Arvac™ SW
- › Plicord® HD Industrial Vacuum
- › Plicord® Vacuum (HD & LW)
- › Spiraflex® Ducting

Continental ContiTech

- › Spiraflex® Grassvac
- › Spiraflex® Vacuum
- › Spirathane® HD
- › Spirathane® LD
- › Spirathane® PT

LPG delivery pro hose



Designed for residential and commercial delivery and transfer applications of liquid propane gas. Working pressures up to 300 psi and temperature ranges from -40°F to 180°F (-40°C to 82°C).

- › LPG Delivery Pro®

Water Discharge hose



Designed for mining, construction, industry, agricultural and marine service applications. Temperatures up to 190°F (88°C) and available in 1/2" to 12" ID.

- › Brigade™ Mine
- › Contractors Water

- › Fire Engine Booster
- › Pathfinder® Garden Hose
- › Plicord® Furnace Door
- › Plicord® HD Water Discharge
- › Plicord® Versiflo® 125
- › Potable Water
- › Prospector™ Water Discharge 150
- › Spiraflex® Black (Lay-Flat Super Duty Hose)
- › Spiraflex® Blue (Extra Light Duty)
- › Spiraflex® Gray (Light Duty)
- › Spiraflex® Red (Medium Duty)
- › Spiraflex® Yellow (Heavy Duty)
- › Sureline®

Suction & discharge hose



Designed for mining, construction, industry, agricultural and marine service applications. Temperatures up to 190°F (88°C) and available in 1/2" to 12" ID.

- › Cold Blue
- › Flexwing® Water S&D
- › Green Hornet® XF
- › Prospector™ Water S&D
- › Spiraflex® 1600
- › Spiraflex® Aggie PVC
- › Spiraflex® HT
- › Versiflo® 150 Water S&D

Washdown hose



General-service hoses for a wide range of industrial, construction and agricultural water discharge. From 1/4" - 1½" ID and temperatures up to 200°F (93°C).

- › Fortress® 300
- › Fortress® 1000
- › Fortress® 3000
- › Gauntlet® 1500
- › Plicord® Washdown
- › Pulp & Paper Washdown
- › Sani-Wash™ 300
- › Sani-Wash™ Plus

- › Super Sani-Wash® 300
- › Sureline®

Welding Hose



Designed for a variety of welding services and applications for Grade R, RM, T. Available in single and Twin Line options.

- › Single Line Welding (Grade R)
- › Single Line Welding (Grade RM)
- › Single Line Welding (Grade T)
- › TIG Welding
- › Twin-Line Welding (Grade R)
- › Twin-Line Welding (Grade RM)
- › Twin-Line Welding (Grade T)

See our line of Prospector™ hose in our Oil & Gas brochure.



Application Warning

The products in this catalog have been tested under controlled laboratory conditions to meet specific test criteria. These tests are not intended to reflect the performance of the product or any other material in any specific application, but are intended to provide the user with application guidelines. The products are intended for use by knowledgeable persons having the technical skills necessary to evaluate their suitability for specific applications.

Since Continental ContiTech, Inc. has no control over the number and variety of applications for which its products may be purchased or the conditions under which its products may be used by others, Continental ContiTech assumes no responsibility for performance results and applications. This catalog, however, contains available information to allow the user to determine the product's acceptability and fitness for specific applications. No statement contained herein shall be construed as a license to operate, or as a recommendation or inducement to infringe existing patents or as an endorsement of products of specific manufacturers or systems.

Failure to follow procedures for selection, installation, care, maintenance and storage of hoses may result in the hose's failure to perform properly and may result in damage to property and/or serious injury. Please refer to the General Information section of the catalog for hose care, maintenance and storage information.

All product design, dimensional and general information in this catalog is subject to change without prior notice. Working pressures and other technical information have been prepared from actual test results and other data considered to be reliable. However, Continental ContiTech assumes no responsibility for the accuracy of this information under varied conditions found in field use.

Chemical Hose

Do not use chemical hose at temperatures or pressures above those recommended by the manufacturer. All operators must be thoroughly trained in the care and use of this hose and must, at all times, wear protective clothing. A hose or system failure could cause the release of poisonous, corrosive or flammable material.

Detailed information concerning storage, care and maintenance may be found in the Hose Handbook published by the Rubber Manufacturer's Association, 1400 K Street, N.W., Washington, D.C. 20005 and in SAE Recommended Practices J1273.

Table of Contents

Introduction

Application Warning	1
Index by Alphabet	3-5
Index by Application	6-8

Continental ContiTech Industrial Hose

Air & Multipurpose

General Purpose	10-26
Heavy Duty	27-34
Push-on	35-40

Chemical Transfer	42-54
Cleaning Equipment	55-67

Food

Transfer	68-91
Washdown	92-99

Marine	101-110
---------------	----------------

Material Handling

Abrasives	111-130
Bulk Transfer	131-140
Cement & Concrete	141-146

Mining	147-156
---------------	----------------

Petroleum

Aircraft Fueling	157-163
Dispensing	164-177
Dock	178-192
Transfer	193-215

Spray	216-218
--------------	----------------

Steam	219-229
--------------	----------------

Vacuum	230-235
---------------	----------------

LPG Delivery	236-237
---------------------	----------------

Water

Discharge	238-248
Suction & Discharge	249-258
Washdown	260-263

Welding	265-271
----------------	----------------

Coupling Systems	273-288
-------------------------	----------------

Equipment	289-300
------------------	----------------

Appendix

Additional Products	301-303
Chemical Resistance Charts	304-324
Spiraflex Hose	
Chemical Resistance Guide	325-330

General Information

Chemical Properties of FEP	331
Method for Steam Cleaning	331
Infinity/Paladin Drop Hose	
Coupling Procedure	332
Basic Hose Construction	333-334
Hose End Definitions and	
Illustrations with Cutaways	335-336
Hose Testing Methods	337-338
Electrical Resistance Tests	339-342
Elastomers Used in	
Product Manufacture	343-344
Selection of Proper Industrial Hose	345
Industrial Hose Inquiry	346
Useful Tables and Conversion Charts	347-348
Length, Weight and Area Conversion Constants	349
Properties of Saturated Steam	350
Flow Data	351-353
Open-end Discharge	354
Fluid Velocity vs. Flow Rate	355
RMA Oil and Gasoline Resistance Definition	356
FDA Food Hose Compliance Information	357
Precautions for Welding Hose Use/	
Background Information	358

Minimum Run Requirements	359
Care, Maintenance and Storage	360-361

Industrial Hose Index By Alphabet

Name	Properties	Page #	Name	Properties	Page #
A			Fire Engine Booster..... 244		
Advantage		161	FLEXAGrip	A, M, NC	39-40
Aggie Gas		172	Flexdock 225		179
Allcrete Textile Plaster, Grout & Concrete.....		143	Flexdock 300.....		180
Allcrete Wire.....		144	Flexible Downspout.....		122
Arctic ExtremeFlex.....		196	Flexshield Marine Barrier Hose SAE J1527 USCG Type A1-15 / ISO 7840.....		108
Arctic Ortac		19	Flexsteel 250 CB Extreme Crimp		224
Arctic Ortac Plus		20	Flexsteel 250 CB Steam.....		223
Artrac.....		118	Flexsteel 250 Steam.....		221
Arvac SW.....		117	Flexsteel 250 EPDM-20		222
B			Flexsteel Futura	UL, CUL	165
BC Cold Flex		173	Flexsteel Futura Ethan-All.....		176
BC Gasoline.....	UL, CUL	174	Flexsteel Futura Low Perm	UL	167
BC Marina.....	UL, CUL	175	Flexsteel Futura HVR	UL	168
Black Softwall		133	Flexsteel Service Station Air		21
Blucor		115	Flexsteel Futura Vapor Assist.....	UL	166
Blucor Couplings.....		116	Flextra Dry Material.....		132
Blue Flexwing.....		54	Flextra Rock Dust.....	M	150
Blue Fortress 300.....		96	Flexwing VersaFuel		197
Blue Low Temp Fuel Oil Delivery.....		194	Flexwing Water S&D.....		256
Braidair.....		25	Fortress 300	A	93
Brigade Mine.....	M	149	Fortress 1000.....	A	94
Brown Flexwing.....		48	Fortress 3000.....	A	95
C			Frontier 200		13-14
Chem One	A	44	Frontier 250		13-14
Cold Blue.....		252	Frontier 300		13-14
Crimped Jackhammer Assembly		34	G		
Crimped Steam Assembly.....		225	Galvanator 3000	A	67
D			Gauntlet 1500.....	A	62
Deadman Aircraft Refueling		162	Gauntlet 3000.....	A	65
DEF Dispensing Hose.....		177	Gauntlet 4500.....	A	64
DEF Transfer Hose.....		45	Gorilla	A, M, NC	12
Diversiflex		119	Gray Flextra LT.....	F	71
Diversipipe 75		120	Green Hornet XF.....		253
Diversipipe 150.....		121	Green XLPE.....		42
E			H		
Exstatic.....	F	72	Harvest.....	F	73
EZ Glide Wine.....		84	Heavy Duty Steam Pile Driver.....		220
F			Hi-Per.....		49
F5		11	Hot Tar & Asphalt Rough & Smooth Bore.....		188
Fabchem.....		47	Hydrocarbon Drain Hose.....		66, 227

Properties Legend:

 **A** - Superior Abrasion Resistance
 **F** - FDA, 3-A, & USDA Compliant
 **UL** - Underwriter's Laboratory Approved
 **M** - USMSHA Approved
 **NC** - Non-Conductive
 **cUL** - Underwriter's Laboratory Approved (Canada)

Industrial Hose Index By Alphabet

Name	Properties	Page #	Name	Properties	Page #
I					
Infinity		198	Neptune 4500		61
Infinity HD		199	Neptune 6000		60
Infinity Stainless Steel & Aluminum Crimp Sleeves		287	NR Spray		217
Insta-Grip 250	A, NC	38	Nutriflex Suction & Discharge	F	75
Insta-Grip 300	M, NC	37	Nutriflex Static Wire	F	76
Insta-Grip TC		39	Nutriflo Suction & Discharge	F	74
Insta-Lock Dust Cap		282	O		
Insta-Lock Dust Plug		283	Oil Rig Service Hose		189-190
Insta-Lock Fittings		280	Orange Flexwing		51
Insta-Lock Gaskets		285	Ortac 250	A, NC	15-16
Insta-Lock Interlocking Ferrules		286	Ortac 300	A, NC	15-16
Insta-Lock Interlocking Stainless Steel NPT Male Hose Stem		281	Ortac 400	A, NC	15-16
Insta-Lock Repair Kits		284	P		
Insta-Lock Type A Fitting		274	Pacer	UL, CUL	171
Insta-Lock Type B Fitting		275	Paladin		201
Insta-Lock Type C Fitting		276	Paladin Stainless Steel & Aluminum Crimp Sleeves		287
Insta-Lock Type D Fitting		277	Pathfinder Garden Hose		245
Insta-Lock Type E Fitting		278	PGC Placement Textile		145
Insta-Lock Type F Fitting		279	Platinum JAC Riser		158
ISO 7840 Marine Barrier Hose		107	Plicord 250 Steam		226
J					
Jet Ranger		160	Plicord Air Green 400	NC	33
L					
LPG Delivery Pro		237	Plicord Ammonium Nitrate HD		153
LW Arctic Tank Truck		208	Plicord Ammonium Nitrate Pellet		152
M					
M&P Mine Conduit	M	151	Plicord Arctic Flexwing		209
Marine Fuel Feed Vent			Plicord Auger Arc Piling		142
USCG/SAE J1527 Type A2		109	Plicord Blast (2 ply & 4 ply)		113
Marine Fuel Feed Vent			Plicord Blue Flour	F	77
USCG/SAE J1527 Type B2		110	Plicord Brewline	F	78
Marine Fuel Line			Plicord Dock Hose		187
USCG/SAE J1527 & ISO 7840 Type A1		107	Plicord Dredge Sleeve		124
Maxxim Premier	UL	169	Plicord ExtremeFlex Beverage Gray		85
Maxxim Premier Plus	UL	170	Plicord ExtremeFlex Beverage Red		86
MIL A-A-59565		27	Plicord ExtremeFlex Brown		52
MIL-DTL-29210E Steam		228	Plicord ExtremeFlex Food Grade		79
Mine Spray	M	148	Plicord ExtremeFlex Petroleum	A	211
N					
Neptune 1500		57	Plicord ExtremeFlex Purple		53
Neptune 3000		59	Plicord Flexwing Petroleum		200
Neptune 4001-R		58	Plicord Fuel Discharge		210
			Plicord Furnace Door		246
			Plicord Gray Food	F	70
			Plicord Gunitite Tan		146
			Plicord HW/SW Dry Cement		185-186
			Plicord Hardwall Wet Exhaust		103-104
			Plicord HD Industrial Vacuum		234
			Plicord HD Water Discharge		247
			Plicord Hydrovator		123

Properties Legend:

 **A** - Superior Abrasion Resistance
 **M** - USMSHA Approved
 **NC** - Non-Conductive
 **F** - FDA, 3-A, & USDA Compliant
 **UL** - Underwriter's Laboratory Approved
 **CUL** - Underwriter's Laboratory Approved (Canada)

Industrial Hose Index By Alphabet

Name	Properties	Page #	Name	Properties	Page #
Plicord LW Black Flextra II		205	Smooth Bore Dock 200		181
Plicord Mine Conduit	M	154	Smooth Bore Dock 300		182
Plicord Oilfield Frac		204	Spiraflex 1600		254
Plicord Pulp & Paper Washdown		263	Spiraflex Aggie PVC		255
Plicord RVC		125	Spiraflex Air Seeder Hose		127
Plicord SAE J1527 Type A2 (fuel fill)		102	Spiraflex Black Lay-Flat Super Duty Hose		239
Plicord Sand Suction		126	Spiraflex Blue Extra Light Duty		240
Plicord Softwall Wet Exhaust		105-106	Spiraflex Cable Guard	M	155
Plicord Super Black Flexwing		203	Spiraflex Ducting		232
Plicord Super Rock Drill	M	32	Spiraflex Grassvac		231
Plicord Torridair Hot Air Blower		134	Spiraflex Gray Light Duty		241
Plicord Vacuum (HD & LW)		235	Spiraflex Mulch Blower		137
Plicord Versiflo 125		251	Spiraflex Polyurethane Vapor Recovery		212
Plicord Water Discharge 150		245	Spiraflex Red Medium Duty	M	242
Plicord Washdown		262	Spiraflex Rock Dust	M	156
Plicord Winline	F	80	Spiraflex Vacuum		233
Plicord XF Blast		114	Spiraflex Yellow (Spiraflex 2700)	M	243
Pliovic Ag Spray (1800 & 2400)		218	SpiraFlow		56
Pliovic FG (FDA-3A)	F	81	Spirathane HD		128
Pliovic GS	NC	23-24	Spirathane LD		130
Pliovic Plus 250	NC	23-24	Spirathane PT	F	129
Potable Water	F	82	Steel Air	M	28
Pressure Washer Fittings		288	Super Ortac	M	29
Prospector Air		30	Super Sani-Wash 300		99
Prospector Oil Field		206-207	Sureline		261
Prospector Plus Air		31			
Prospector Water Discharge 150		248	T		
Prospector Water S&D		258	Tan Flextra	F	88, 139
Purple Flexwing		51	Tan Flexwing	F	87, 138
Pyroflex II Hot Air		135	Tan Softwall	F	89, 140
Pyroflex III Hot Air		136	Tanker Barge Discharge		183
Pyroflex Hot Tar & Asphalt II		213	Twin-Line Welding Grade R		266
Pyroflex Hot Tar Wand		214	Twin-Line Welding Grade RM	NC	267
			Twin-Line Welding Grade T	NC	268
R					
RB Dock Asphalt		191	V		
Red Flextra 100		202	Vapor Recovery Dock		184
Red Flextra 150		202	VariFlex 200	NC	17-18
Redwing Fuel Oil		195	VariFlex 300	NC	17-18
Refueling Sensing		163	Velocity Beverage Transfer		90
			Velocity WT		250
S			Versiflo 150 Water S&D		257
Sandblast Deadman		112	Vintner	F	83
Sani-Wash 300		98	Viper	A	46
Sani-Wash Plus 300		97			
SB Dock Asphalt & Bitumen		192	W		
Service Station Air		22	White Flexwing	F	69
Single Line Welding Grade R		270	Whitewater		61
Single Line Welding Grade RM	NC	271	Wingcraft		159
Single Line Welding Grade T		269			

Properties Legend:

 **A** - Superior Abrasion Resistance
 **F** - FDA, 3-A, & USDA Compliant
 **UL** - Underwriter's Laboratory Approved
 **M** - USMSHA Approved
 **NC** - Non-Conductive
 **CUL** - Underwriter's Laboratory Approved (Canada)

Industrial Hose Index By Application

Name	Properties	Page #	Name	Properties	Page #
Air & Multipurpose: General Purpose					
Arctic Ortac		19	Galvanator 3000	A	67
Arctic Ortac Plus		20	Gauntlet 1500	A	64
Braidair		25	Gauntlet 3000	A	67
F5		11	Gauntlet 4500	A	66
Flexsteel Service Station Air		20	Hydrocarbon Drain Hose		66
Frontier 200		13-14	Neptune 1500		57
Frontier 250		13-14	Neptune 3000		59
Frontier 300		13-14	Neptune 4001-R		58
Gorilla	A, M, NC	12	Neptune 4500		61
MIL A-A-59565		27	Neptune 6000		60
Ortac 250	A, NC	15-16	SpiraFlow		56
Ortac 300	A, NC	15-16	Whitewater		63
Ortac 400	A, NC	15-16	Food: Food Transfer		
Pliovic FG (FDA-3A)	F	79	Exstatic	F	72
Pliovic GS	NC	23-24	Exstatic	F	84
Pliovic Plus 250	NC	23-24	Gray Flextra LT	F	71
Service Station Air		22	Harvest	F	73
Variflex 200	NC	17-18	Nutriflex Suction & Discharge	F	75
Variflex 300	NC	17-18	Nutriflex Static Wire	F	76
Air & Multipurpose: Heavy Duty			Nutriflo Suction & Discharge	F	75
Crimped Jackhammer Assembly		34	Plicord Blue Flour	F	77
Plicord Air Green 400	NC	33	Plicord Brewline	F	78
Plicord Super Rock Drill	M	32	Plicord ExtremeFlex Beverage Gray	F	85
Prospector Air		30	Plicord ExtremeFlex Beverage Red	F	86
Prospector Plus Air		31	Plicord ExtremeFlex Food Grade	F	79
Steel Air	M	28	Plicord Gray Food	F	70
Super Ortac	M	29	Plicord Winline	F	80
Air & Multipurpose: Push-on			Pliovic FG (FDA-3A)	F	81
FLEXAGrip	A, M, NC	39-40	Potable Water	F	82
Insta-Grip 250	A, NC	37	Spirathane PT	F	129
Insta-Grip 300	M, NC	36	Tan Flextra	F	88
Insta-Grip TC		38	Tan Flexwing	F	87
Chemical Transfer			Tan Softwall	F	89
Blue Flexwing		54	Velocity Beverage Transfer		90
Brown Flexwing		48	Vintner	F	83
Chem One	A	44	White Flexwing	F	69
DEF Transfer Hose		45	Food: Food Washdown		
Fabchem		47	Blue Fortress 300		99
Green XLPE		42	Fortress 300	A	93
Hi-Per		49	Fortress 1000	A	94
Orange Flexwing		51	Fortress 3000	A	95
Plicord ExtremeFlex Brown		52	Gauntlet 1500	A	62
Plicord ExtremeFlex Purple		53	Plicord Washdown		262
Purple Flexwing		51	Sani-Wash 300		98
Viper	A	46	Sani-Wash Plus 300		97
Cleaning Equipment			Super Sani-Wash 300		99
Fortress 300		93	Marine		
Fortress 1000	A	94	Flexshield Marine Barrier Hose SAE		
Fortress 3000	A	95	J1527 USCG Type A1-15 / ISO 7840		111
			Marine Fuel Feed Vent Hose		
			USCG/SAE J1527 Type A2		109
			Marine Fuel Feed Vent Hose		
			USCG/SAE J1527 Type B2		110

Properties Legend:

-  **A** - Superior Abrasion Resistance
-  **M** - USMSHA Approved
-  **NC** - Non-Conductive
-  **F** - FDA, 3-A, & USDA Compliant
-  **UL** - Underwriter's Laboratory Approved
-  **cUL** - Underwriter's Laboratory Approved (Canada)

Industrial Hose Index By Application

Name	Properties	Page #
Marine Fuel Line USCG/SAE J1527 & ISO 7840 Type A1		107
Plicord Hardwall Wet Exhaust		103-104
Plicord SAE J1527 Type A2 (fuel fill)		102
Plicord Softwall Wet Exhaust		105-106

Material Handling: Abrasives

Artrac		121
Arvac SW		120
Blucor		118
Blucor Couplings		119
Diversiflex		122
Diversipipe 75		123
Diversipipe 150		124
Flexible Downspout		122
Nutriflex Static Wire	F	76
Plicord Blast (2 ply & 4 ply)		113
Plicord Dredge Sleeve		124
Plicord Hydrovator		123
Plicord RVC		125
Plicord Sand Suction		126
Plicord XF Blast (2 ply & 4 ply)		114
Sandblast Deadman		112
Spiraflex Air Seeder Hose		127
Spirathane HD		128
Spirathane LD		130
Spirathane PT	F	129

Material Handling: Bulk Transfer

Black Softwall		133
Flextra Dry Material		132
Spiraflex Mulch Blower		137
Plicord Torridair Hot Air Blower		134
Pyroflex II Hot Air		135
Pyroflex III		136
Tan Flextra	F	139
Tan Flexwing	F	138
Tan Softwall	F	140

Material Handling: Cement & Concrete

Allcrete Textile Plaster Grout & Concrete		143
Allcrete Wire		144
PGC Placement Textile		145
Plicord Auger Arc Piling		142
Plicord Gunita Tan		146

Mining

Brigade Mine	M	146
Flextra Rock Dust	M	150
M&P Mine Conduit	M	151
Mine Spray	M	148
Plicord Ammonium Nitrate HD		153
Plicord Ammonium Nitrate Pellet		152
Plicord Mine Conduit	M	154
Spiraflex Cable Guard	M	155

Name	Properties	Page #
Spiraflex Red Medium Duty	M	242
Spiraflex Rock Dust	M	156
Spiraflex Yellow (Spiraflex 2700)	M	243
Steel Air	M	28
Super Ortac	M	29

Petroleum: Aircraft Fueling

Advantage		161
Deadman Aircraft Refueling		162
Jet Ranger		160
Platinum JAC Riser		158
Refueling Sensing		163
Wingcraft		159

Petroleum: Petroleum Dispensing

Aggie Gas		172
BC Cold Flex		173
BC Gasoline	UL, CUL	174
BC Marina	UL, CUL	175
DEF Dispensing Hose		177
Flexsteel Futura Ethan-All		176
Flexsteel Futura	UL, CUL	165
Flexsteel Futura Low Perm	UL, CUL NEW	167
Flexsteel Futura HVR	UL, CUL NEW	168
Flexsteel Futura Vapor Assist	UL	166
Maxxim Premier	UL	169
Maxxim Premier Plus	UL	170
Pacer	UL, CUL	171

Petroleum: Petroleum Dock Hose

Flexdock 225		179
Flexdock 300		180
Hot Tar & Asphalt Rough & Smooth Bore		188
Smooth Bore Dock 200		181
Smooth Bore Dock 300		182
Tanker Barge Discharge		183
Oil Rig Service		189-190
Plicord Dock Hose		187
Plicord HW Dry Cement/Barytes		185
Plicord SW Dry Cement/Barytes		186
RB Dock Asphalt & Bitumen		191
SB Dock Asphalt & Bitumen		192
Vapor Recovery Dock		184

Petroleum: Petroleum Transfer

Arctic ExtremeFlex		196
Blue Low Temp Fuel Oil Delivery		194
Flexwing VersaFuel		197
Infinity		198
Infinity HD		199
LW Arctic Tank Truck		208
Paladin		201
Plicord Arctic Flexwing		209
Plicord ExtremeFlex Petroleum	A	211
Plicord Flexwing Petroleum		200

Properties Legend:

 A - Superior Abrasion Resistance
 F - FDA, 3-A, & USDA Compliant
 UL - Underwriter's Laboratory Approved
 M - USMSHA Approved
 NC - Non-Conductive
 CUL - Underwriter's Laboratory Approved (Canada)

Industrial Hose Index By Application

Name	Properties	Page #	Name	Properties	Page #
Plicord Fuel Discharge		210	Spiraflex Red Medium Duty	M	242
Plicord LW Black Flextra II		205	Spiraflex Yellow Heavy Duty	M	243
Plicord Oilfield Frac		204	Water: Suction & Discharge Hose		
Plicord Super Black Flexwing		203	Cold Blue		255
Prospector Oilfield 150		206	Flexwing Water S&D		256
Prospector Oilfield 300		203	Green Hornet XF		253
Pyroflex Hot Tar & Asphalt II		213	Plicord Versiflo 125		251
Pyroflex Hot Tar Wand		214	Prospector Water S&D		258
Red Flextra 100		202	Spiraflex 1600		254
Red Flextra 150		202	Spiraflex Aggie PVC		255
Redwing Fuel Oil		195	Velocity WT		250
Spiraflex Polyurethane Vapor Recovery		212	Versiflo 150 Water S&D		257
Spray Hose			Water: Washdown Hose		
Mine Spray	M	148	Fortress 300	A	93
NR Spray		217	Fortress 1000	A	94
Plovic Ag Spray (1800 & 2400)		218	Fortress 3000	A	95
Steam Hose			Gauntlet 1500	A	61
Crimped Steam Assembly		225	Plicord Pulp & Paper Washdown		263
Flexsteel 250 CB Extreme Crimp		224	Plicord Washdown		262
Flexsteel 250 CB Steam		223	Sani-Wash 300		98
Flexsteel 250 EPDM-20		222	Sani-Wash Plus 300		97
Flexsteel 250 Steam		221	Super Sani-Wash 300		99
Heavy Duty Steam Pile Driver		220	Sureline		261
Hydrocarbon Drain Hose		227	Welding Hoses		
MIL-DTL-29210E		228	Single Line Welding Grade R		270
Plicord 250 Steam		226	Single Line Welding Grade RM		271
Vacuum Hose			Single Line Welding Grade T		269
Arvac SW		114	Twin-Line Welding Grade R		266
Plicord HD Industrial Vacuum		234	Twin-Line Welding Grade RM	NC	267
Plicord Vacuum (HD & LW)		235	Twin-Line Welding Grade T	NC	268
Spiraflex Ducting		232	Coupling Systems		
Spiraflex Grassvac		231	Infinity Stainless Steel &		
Spiraflex Vacuum		233	Aluminum Crimp Sleeves		287
Spirathane HD		128	Insta-Lock Dust Cap		272
Spirathane LD		130	Insta-Lock Dust Plug		283
Spirathane PT	F	129	Insta-Lock Fittings		280
LPG Delivery			Insta-Lock Gaskets		285
LPG Delivery Pro	UL	237	Insta-Lock Interlocking Ferrules		286
Water: Discharge Hose			Insta-Lock Interlocking Stainless		
Brigade Mine	M	149	Steel Male NPT Hose Stem		281
Fire Engine Booster		244	Insta-Lock Repair Kits		284
Pathfinder Garden Hose		245	Insta-Lock Type A Fitting		274
Plicord Furnace Door		246	Insta-Lock Type B Fitting		275
Plicord HD Water Discharge		247	Insta-Lock Type C Fitting		276
Potable Water	F	82	Insta-Lock Type D Fitting		277
Prospector Water Discharge 150		248	Insta-Lock Type E Fitting		278
Spiraflex Black Lay-Flat Super Duty		239	Insta-Lock Type F Fitting		279
Spiraflex Blue Extra Light Duty		240	Paladin Stainless Steel &		
Spiraflex Gray Light Duty		241	Aluminum Crimp Sleeves		287
			Pressure Washer Fittings		288

Properties Legend:

-  A - Superior Abrasion Resistance
-  M - USMSHA Approved
-  NC - Non-Conductive
-  F - FDA, 3-A, & USDA Compliant
-  UL - Underwriter's Laboratory Approved
-  CUL - Underwriter's Laboratory Approved (Canada)

Notes

Air & Multipurpose

General Purpose

Heavy Duty

Push-on

Chemical Transfer

Cleaning Equipment

Food

Transfer

Washdown

Marine

Material Handling

Abrasives

Bulk Transfer

Cement & Concrete

Mining

Petroleum

Aircraft Fueling

Dispensing

Dock

Transfer

Spray

Steam

Vacuum

LPG Delivery

Water

Discharge

Suction & Discharge

Washdown

Welding

Coupling Systems

Equipment

Appendix

General Purpose



	Page	Superior Abrasion Cover	MSHA	Non conductive	Oil Resistance Tube*	Oil Resistance Cover*	Temp. Range	Thermo- plastic	Rubber
Arctic Ortac	19				A	A	-65°F to 180°F (-54°C to 82°C)		Yes
Arctic Ortac Plus	20				A	A	-65°F to 180°F (-54°C to 82°C)		Yes
Braidair	25				A	B	-20°F to 190°F (-29°C to 88°C)		Yes
F5	11				B	B	-40°F to 158°F (-40°C to 70°C)	Yes	
Flexsteel Service Station Air	21				B	B	-20°F to 190°F (-29°C to 88°C)		Yes
Frontier 200	13-14				C	C	-40°F to 190°F (-40°C to 88°C)		Yes
Frontier 250	13-14				C	C	-40°F to 190°F (-40°C to 88°C)		Yes
Frontier 300	13-14				C	C	-40°F to 190°F (-40°C to 88°C)		Yes
Gorilla	12	Yes	Yes	Yes	A	A	-20°F to 190°F (-29°C to 88°C)		Yes
Mil A-A-59565 Military Air Hose	26				C	C	-40°F to 190°F (-40°C to 88°C)		
Ortac 250	15-16	Yes		Yes	A	A	-20°F to 190°F (-29°C to 88°C)		Yes
Ortac 300	15-16	Yes		Yes	A	A	-20°F to 190°F (-29°C to 88°C)		Yes
Ortac 400	15-16	Yes	Yellow Only	Yes	A	A	-20°F to 190°F (-29°C to 88°C)		Yes
Pliovic FG (FDA-3A)	79			Yes	B	B	-10°F to 158°F (-40°C to 70°C)	Yes	
Pliovic GS	23-24			Yes	B	B	-10°F to 158°F (-40°C to 70°C)	Yes	
Pliovic Plus 250	23-24			Yes	B	B	-10°F to 158°F (-40°C to 70°C)	Yes	
Service Station Air	22				C	C	-40°F to 190°F (-40°C to 88°C)		Yes
VariFlex 200	17-18			Yes	A	A	-20°F to 190°F (-29°C to 88°C)		Yes
VariFlex 300	17-18			Yes	A	A	-20°F to 190°F (-29°C to 88°C)		Yes

*Based on RMA oil classification. For more information, see Appendix C.

Air & Multipurpose
General Purpose
Heavy Duty
Push-on

Chemical Transfer

Cleaning Equipment

Food
Transfer
Washdown

Marine

Material Handling
Abrasives
Bulk Transfer
Cement & Concrete

Mining

Petroleum
Aircraft Fueling
Dispensing
Dock
Transfer

Spray

Steam

Vacuum

LPG Delivery

Water
Discharge
Suction & Discharge
Washdown

Welding

Coupling Systems

Equipment

Appendix

F5™ Air Hose



Air & Multipurpose
General Purpose
Heavy Duty
Push-on

Chemical Transfer

Cleaning Equipment

Food
Transfer
Washdown

Marine

Material Handling
Abrasives
Bulk Transfer
Cement & Concrete

Mining

Petroleum
Aircraft Fueling
Dispensing
Dock
Transfer

Spray

Steam

Vacuum

LPG Delivery

Water
Discharge
Suction & Discharge
Washdown

Welding

Coupling Systems

Equipment

Appendix

Product Specifications

Application

A hybrid thermoplastic hose that provides durability and flexibility, is lightweight and has a low drag resistance. F5™ is non-marking, oil resistant and performs well under cold temperatures to -40°F (-40°C). This 300 psi hose is designed for a variety of pneumatic applications in industries such as construction and manufacturing.

Construction Tube

Blue Flexible TPE, RMA Class B (Medium Oil Resistance)

Cover

Matte Blue Flexible TPE, RMA Class B (Medium Oil Resistance)

Reinforcement

Polyester yarn

Temperature Range

-40°F to 158°F (-40°C to 70°C)

Packaging

25', 50' or 100' coils, 750' or 1,000' reels

Branding

Example: F5™ 300 psi. Made in U.S.A. Continental ContiTech

Couplings

MxM NPT for coupled assemblies

Order Codes

540-438 (blue)

F5™ Air Hose

SAP #	ID	Nom. OD		Max. WP		Weight		
		in.	mm	psi	MPa	lb./ft.	kg/m	
20463343	1/4	6.6	.50	11.5	300	2.07	0.06	0.09
20476820	5/16	7.9	.59	15.0	300	2.07	0.09	0.15
20463342	3/8	9.8	.64	16.2	300	2.07	0.10	0.16
20463341	1/2	12.7	.81	20.0	300	2.07	0.16	0.24
20470081	3/4	18.9	1.11	28.1	300	2.07	0.26	0.36
20476821	1	25.4	1.37	34.8	200	1.38	0.35	0.52

Gorilla®



Air & Multipurpose
General Purpose
Heavy Duty
Push-on

Chemical Transfer

Cleaning Equipment

Food
Transfer
Washdown
Marine

Material Handling
Abrasives
Bulk Transfer
Cement & Concrete

Minig

Petroleum
Aircraft Fueling
Dispensing
Dock
Transfer

Spray

Steam

Vacuum

LPG Delivery

Water
Discharge
Suction & Discharge

Washdown

Welding

Coupling Systems

Equipment

Appendix

Product Specifications

Application

A premium-quality, multipurpose industrial hose with a wide range of applications in factories, construction, agriculture, quarries, mines, railroads, the oil and gas industry, and shipbuilding. All sizes are rated at 500 psi (3.4 MPa) maximum working pressure. Non-conductive, minimum electrical resistance greater than one (1) megaohm per inch of hose length at 1000 Volts DC.

Construction Tube

Nitrile synthetic rubber, RMA Class A (High Oil Resistance)

Cover

Yellow Carbryn™ synthetic rubber, RMA Class A (High Oil Resistance) MSHA approved

Reinforcement

Spiral aramid yarn, 2" is braided synthetic yarn

Temperature Range

-20°F to 190°F (-29°C to 88°C)

Packaging

90% one piece reels up to 1 inch

3/16" - 3/4" - 500' reels, maximum 3 pieces, 50' increments
1" - 450' reels, maximum 3 pieces, 50' increments
1 1/4" - 250'-400' reels, maximum 3 pieces, 50' increments
1 1/2" - 150'-300' reels, maximum 3 pieces, 50' increments
2" - 200' carton, maximum 3 pieces, 50' increments
Coupled assemblies available: 1/4", 3/8", 1/2", and 3/4".

Branding

Example: Gorilla® 1" (25.4 mm) 500 psi. Made in U.S.A. Continental ContiTech. Flame Resistant USMSHA No. 2

Couplings

Contact fitting manufacturer for proper fitting recommendation and coupling procedure.

Order Codes

569-035
536-446 (2")

Gorilla®

SAP #	ID	Nom OD		Max. WP		Weight		
Yellow	in.	mm	in.	mm	psi	MPa	lb./ft.	kg/m
20026239	1/4	6.4	0.61	15.5	500	3.45	0.17	0.23
20026255	5/16	7.9	0.69	17.5	500	3.45	0.20	0.30
20026256	3/8	9.5	0.73	18.6	500	3.45	0.22	0.33
20026273	1/2	12.7	0.89	22.6	500	3.45	0.28	0.42
20026289	5/8	15.9	1.06	26.9	500	3.45	0.35	0.52
20026290	3/4	19.1	1.19	30.2	500	3.45	0.41	0.61
20026304	1	25.4	1.50	37.8	500	3.45	0.58	0.86
20026306	1 1/4	31.8	1.77	45.6	500	3.45	0.79	1.18
20026309	1 1/2	38.1	2.04	51.8	500	3.45	0.86	1.27
20023183	2	50.8	2.62	66.6	500	3.45	1.22	1.82

Frontier



Air & Multipurpose
General Purpose
Heavy Duty
Push-on

Chemical Transfer

Cleaning Equipment

Food
Transfer
Washdown

Marine

Material Handling
Abrasives
Bulk Transfer
Cement & Concrete

Mining

Petroleum
Aircraft Fueling
Dispensing
Dock
Transfer

Spray

Steam

Vacuum

LPG Delivery

Water
Discharge
Suction & Discharge
Washdown

Welding

Coupling Systems

Equipment

Appendix

Product Specifications

Application

An economical air and water hose, Frontier is for a wide range of industrial, construction and agricultural applications. Available in 200, 250, and 300 psi working pressures.

Construction Tube

EPDM synthetic rubber, RMA Class C (Limited Oil Resistance)

Cover

Black, Red, Yellow, Green or Blue EPDM synthetic rubber Class C (Limited Oil)

Reinforcement

Spiral synthetic yarn, 2" is braided

Temperature Range

-40°F to 190°F (-40°C to 88°C)

Packaging

90% one piece reels up to 1 inch
3/16"-3/4" - 500' reels, maximum 3 pieces, 50' increments
1" - 450' reels, maximum 3 pieces, 50' increments

1/4" - 400' reels, maximum 3 pieces, 50' increments
1/2" - 300' reels, maximum 3 pieces, 50' increments
2" - 200', cartons, maximum 3 pieces, 50' increments
Coupled assemblies available in 1/4", 3/8", 1/2", and 3/4" in red.

Branding

Example: 1/2" Frontier Continental ContiTech 300 psi WP

Couplings

Contact fitting manufacturer for proper fitting recommendation and coupling procedure.

Order Codes

See next page

EPDM is a registered trademark of Continental ContiTech.

Frontier 200

Order Codes: 536-035 (2" black), 536-040 (2" red), 569-009 (black), 569-011 (red), 569-038 (yellow), 569-547 (blue)

SAP #				ID		Nom. OD		Max. WP		Weight	
Black	Red	Blue	Yellow	in.	mm	in.	mm	psi	MPa	lb./ft.	kg/m
20025544	20025733		20709043	3/16	4.8	0.44	11.2	200	1.38	0.08	0.12
20025553	20025735	20026919	20654587	1/4	6.4	0.50	12.7	200	1.38	0.09	0.13
20025565	20025748	20026920		5/16	7.9	0.58	14.7	200	1.38	0.12	0.18
20025572	20025750	20338093	20026337	3/8	9.5	0.67	17.0	200	1.38	0.15	0.22
20025591	20025773	20026921	20026353	1/2	12.7	0.81	20.6	200	1.38	0.20	0.30
20025610	20025787	20026923		5/8	15.9	0.97	24.6	200	1.38	0.27	0.40
20025619	20025799	20026925	20026358	3/4	19.1	1.12	28.5	200	1.38	0.34	0.51
20025714	20025966	20026928	20026361	1	25.4	1.44	36.8	200	1.38	0.54	0.80
20025649	20025826	20736320	20026364	1¼	31.8	1.73	44.0	200	1.38	0.75	1.12
20025655	20025834	20340494	20026366	1½	38.1	1.98	50.3	200	1.38	0.86	1.28
20022897	20022939			2	50.8	2.50	63.5	200	1.38	1.16	1.73

Frontier 250

Order Codes: 569-010 (black), 569-012 (red), 569-039 (yellow), 569-506 (green), 569-548 (blue)

SAP #					ID		Nom. OD		Max. WP		Weight	
Black	Red	Yellow	Green	Blue	in.	mm	in.	mm	psi	MPa	lb./ft.	kg/m
20025667	20025844	20026368	20742873	20742876	1/4	6.4	0.53	13.5	250	1.72	0.11	0.16
20025670	20025865				5/16	7.9	0.59	15.0	250	1.72	0.13	0.19
20025674	20025869	20026374	20742874	20617089	3/8	9.5	0.70	17.8	250	1.72	0.17	0.25
20025685	20025899	20026375	20026807	20617190	1/2	12.7	0.84	21.3	250	1.72	0.22	0.33
20025695	20025922	20026376			5/8	15.9	0.98	24.9	250	1.72	0.27	0.40
20025701	20025932	20026379	20026809	20026929	3/4	19.1	1.14	29.0	250	1.72	0.35	0.52

Frontier 300

Order Codes: 569-516 (yellow), 569-557 (red), 569-560 (green), 569-559 (black), 569-562 (blue)

SAP #				ID		Nom. OD		Max. WP		Weight	
Red	Yellow	Green	Black	in.	mm	in.	mm	psi	MPa	lb./ft.	kg/m
20026960			20026997	1/4	6.4	0.53	13.5	300	2.07	0.10	0.15
20026971	20127382	20761181	20027001	3/8	9.5	0.70	17.8	300	2.07	0.17	0.25
20026980	20127385	20761182	20027003	1/2	12.7	0.84	21.3	300	2.07	0.22	0.33
20026985	20026845	20048519	20183079	3/4	19.1	1.15	29.2	300	2.07	0.37	0.55
20026992	20026859	20048546	20027011	1	25.4	1.48	37.3	300	2.07	0.58	0.86

- Air & Multipurpose**
General Purpose
Heavy Duty
Push-on

- Chemical Transfer

- Cleaning Equipment

- Food**
Transfer
Washdown

- Marine

- Material Handling**
Abrasives
Bulk Transfer
Cement & Concrete

- Mining

- Petroleum**
Aircraft Fueling
Dispensing
Dock
Transfer

- Spray

- Steam

- Vacuum

- LPG Delivery

- Water**
Discharge
Suction & Discharge
Washdown

- Welding

- Coupling Systems

- Equipment

- Appendix

Ortac®



Air & Multipurpose
General Purpose
Heavy Duty
Push-on

Chemical Transfer

Cleaning Equipment

Food
Transfer
Washdown

Marine

Material Handling
Abrasives
Bulk Transfer
Cement & Concrete

Mining

Petroleum
Aircraft Fueling
Dispensing
Dock
Transfer

Spray

Steam

Vacuum

LPG Delivery

Water
Discharge
Suction & Discharge
Washdown

Welding

Coupling Systems

Equipment

Appendix

Product Specifications

Application

Ortac® (Oil Resistant Tube and Cover) is our most popular premium-quality multipurpose hose. Used in the most abusive industrial applications, Ortac® will handle air, oil, water, kerosene and some chemicals. Non-conductive, minimum electrical resistance greater than one (1) megohm per inch of hose length; at 1000 volts DC. Available in 250, 300 and 400 psi working pressures. Note: Ortac® 400 Yellow is USMSHA approved.

Construction Tube

Nitrile synthetic rubber, RMA Class A (High Oil Resistance)

Cover

Red or Yellow Carbryn™ synthetic rubber, RMA Class A (High Oil Resistance)

Reinforcement

Spiral synthetic yarn, 2" is braided

Temperature Range

-20°F to 190°F (-29°C to 88°C)

Packaging

90% one piece reels up to 1 inch
3/16"-3/4" - 500' reels, maximum 3 pieces, 50' increments
1" - 450' reels, maximum 3 pieces, 50' increments
1¼" - 400' reels, maximum 3 pieces, 50' increments
1½" - 300' reels, maximum 3 pieces, 50' increments
2" - 200' cartons, maximum 3 pieces, 50' increments

Branding

Example: 1½" (38.1mm) Ortac® 300 psi WP. Made in U.S.A. Continental ContiTech

Couplings

Contact fitting manufacturer for proper fitting recommendation and coupling procedure.

Order Codes

See next page

Ortac® 250

Order Codes: 569-058 (1/4"-1½" red), 536-465 (2" red), 536-010 (2" black)

SAP #	ID		Nom. OD		Max. WP		Weight		
	Red	in.	mm	in.	mm	psi	MPa	lb./ft.	kg/m
20026527	1/4		6.4	0.53	13.5	250	1.72	0.09	0.13
20026529	5/16		7.9	0.62	17.5	250	1.72	0.14	0.21
20026531	3/8		9.5	0.69	17.5	250	1.72	0.15	0.22
20026534	1/2		12.7	0.84	21.3	250	1.72	0.20	0.30
20026538	5/8		15.9	1.00	25.4	250	1.72	0.26	0.39
20026540	3/4		19.1	1.14	29.0	250	1.72	0.34	0.51
20026544	1		25.4	1.47	37.3	250	1.72	0.51	0.76
20023278	2		50.8	2.50	63.5	200	1.37	1.08	1.61

Ortac® 300

Order Codes: 569-059 (red)

SAP #	ID		Nom. OD		Max. WP		Weight		
	Red	in.	mm	in.	mm	psi	MPa	lb./ft.	kg/m
20026560	3/16		4.8	0.44	11.8	300	2.07	0.07	0.10
20026561	1/4		6.4	0.61	15.7	300	2.07	0.14	0.21
20026563	5/16		7.9	0.68	17.3	300	2.07	0.16	0.24
20026564	3/8		9.5	0.73	18.6	300	2.07	0.18	0.27
20026568	1/2		12.7	0.89	22.6	300	2.07	0.25	0.37
20026570	5/8		15.9	1.06	26.9	300	2.07	0.35	0.52
20026571	3/4		19.1	1.19	30.2	300	2.07	0.40	0.60
20026575	1		25.4	1.50	38.1	300	2.07	0.59	0.88
20026579	1¼		31.8	1.81	46.0	300	2.07	0.76	1.13
20026583	1½		38.1	2.08	52.8	300	2.07	0.88	1.31

Ortac® 400

Order Codes: 569-065 (yellow), (USMSHA rated), 569-066 (red)

SAP #	ID		Nom. OD		Max. WP		Weight		
	Yellow	in.	mm	in.	mm	psi	MPa	lb./ft.	kg/m
20026596	1/4		6.4	0.61	15.7	400	2.76	0.16	0.24
20026598	3/8		9.5	0.73	18.8	400	2.76	0.20	0.30
20026599	1/2		12.7	0.89	22.8	400	2.76	0.26	0.39
20026600	3/4		19.1	1.18	30.0	400	2.76	0.41	0.61
20026601	1		25.4	1.50	38.1	400	2.76	0.61	0.91

- Air & Multipurpose**
General Purpose
Heavy Duty
Push-on

- Chemical Transfer

- Cleaning Equipment

- Food**
Transfer
Washdown

- Marine

- Material Handling**
Abrasives
Bulk Transfer
Cement & Concrete

- Mining

- Petroleum**
Aircraft Fueling
Dispensing
Dock
Transfer

- Spray

- Steam

- Vacuum

- LPG Delivery

- Water**
Discharge
Suction & Discharge
Washdown

- Welding

- Coupling Systems

- Equipment

- Appendix

VariFlex™



Air & Multipurpose
General Purpose
Heavy Duty
Push-on

Chemical Transfer

Cleaning Equipment

Food
Transfer
Washdown

Marine

Material Handling
Abrasives
Bulk Transfer
Cement & Concrete

Mining

Petroleum
Aircraft Fueling
Dispensing
Dock
Transfer

Spray

Steam

Vacuum

LPG Delivery

Water
Discharge
Suction & Discharge
Washdown

Welding

Coupling Systems

Equipment

Appendix

Product Specifications

Application

A good-quality, economical general purpose hose for industrial air service, compressor lines, pneumatic tools, low-pressure spray and many other applications where the need for oil resistance is moderate. Non-conductive, minimum electrical resistance greater than one (1) megohm per inch of length of hose at 1000 volts DC. Available in 200 and 300 psi working pressures.

Construction Tube

Nitrile synthetic rubber, RMA Class A (High Oil Resistance)

Cover

Red, Blue or Black Chemivic™ synthetic rubber, RMA Class A (High Oil Resistance)

Reinforcement

Spiral synthetic yarn (3/16"-1½"), braided synthetic yarn (2")

Temperature Range

-20°F to 190°F (-29°C to 88°C)

Packaging

90% one piece reels up to 1 inch
3/16"-3/4" - 500' reels, maximum 3 pieces, 50' increments
1" - 450' reels, maximum 3 pieces, 50' increments
1¼" - 400' reels, maximum 3 pieces, 50' increments
1½" - 300' reels, maximum 3 pieces, 50' increments
Coupled assemblies available in 1/4", 3/8" and 1/2" in red.

Branding

Example: VariFlex™ non-conductive 1/2" (12.7mm) 200 psi WP. Made in U.S.A. Continental ContiTech

Couplings

Contact fitting manufacturer for proper fitting recommendation and coupling procedure.

Order Codes

See below.

VariFlex™ 200

Order Codes: 569-005 (black), 569-007 (red), 569-036 (blue)

SAP #			ID		Nom. OD		Max. WP		Weight	
Black	Red	Blue	in.	mm	in.	mm	psi	MPa	lb./ft.	kg/m
20666346			3/16	4.8	0.44	11.2	200	1.38	0.07	0.10
20025396	20025484		1/4	6.4	0.53	13.5	200	1.38	0.10	0.15
20025397	20025485		5/16	7.9	0.63	16.0	200	1.38	0.14	0.21
20025399	20025487		3/8	9.5	0.69	17.5	200	1.38	0.15	0.22
20025402	20025490	20147654	1/2	12.7	0.84	21.3	200	1.38	0.21	0.31
20025403	20025492	20612705	5/8	15.9	1.00	25.4	200	1.38	0.27	0.40
20025404	20025493	20026313	3/4	19.1	1.13	28.7	200	1.38	0.38	0.57
20025405	20025495		1	25.4	1.47	37.3	200	1.38	0.58	0.86

VariFlex™ 300

Order Codes: 569-006 (black), 569-008 (3/16"-1 1/2" red), 569-037 (blue), 536-037 (2" red)

SAP #			ID		Nom. OD		Max. WP		Weight	
Black	Blue	Red	in.	mm	in.	mm	psi	MPa	lb./ft.	kg/m
20025408		20025498	1/4	6.4	0.54	13.7	300	2.07	0.14	0.21
20025428		20025499	5/16	7.9	0.64	16.3	300	2.07	0.18	0.27
20025430	20026318	20025502	3/8	9.5	0.69	17.5	300	2.07	0.19	0.28
20025450	20026319	20025512	1/2	12.7	0.86	21.8	300	2.07	0.26	0.39
20333327	20026322	20025518	5/8	15.9	1.02	25.9	300	2.07	0.33	0.49
20025471	20026323	20025522	3/4	19.1	1.19	30.2	300	2.07	0.42	0.63
20025477	20026334	20025532	1	25.4	1.50	38.1	300	2.07	0.62	0.92
20026192		20022900	1 1/4	31.8	1.77	45.6	250	1.72	0.84	1.25
20026194		20022906	1 1/2	38.1	2.08	53.2	250	1.72	1.01	1.50
20530997		20585903	2	50.8	2.50	63.5	300	2.07	1.02	1.52

Air & Multipurpose General Purpose Heavy Duty Push-on
Chemical Transfer
Cleaning Equipment
Food Transfer Washdown
Marine
Material Handling Abrasives Bulk Transfer Cement & Concrete
Mining
Petroleum Aircraft Fueling Dispensing Dock Transfer
Spray
Steam
Vacuum
LPG Delivery
Water Discharge Suction & Discharge Washdown
Welding
Coupling Systems
Equipment
Appendix

Arctic Ortac®



Air & Multipurpose
General Purpose
Heavy Duty
Push-on

Chemical Transfer

Cleaning Equipment

Food
Transfer
Washdown

Marine

Material Handling
Abrasives
Bulk Transfer
Cement & Concrete

Mining

Petroleum
Aircraft Fueling
Dispensing
Dock
Transfer

Spray

Steam

Vacuum

LPG Delivery

Water
Discharge
Suction & Discharge
Washdown

Welding

Coupling Systems

Equipment

Appendix

Product Specifications

Application

Arctic Ortac® (Oil Resistant Tube and Cover) is our most popular cold temperature multipurpose hose. For use with air, water, oil, kerosene, fuel oil and some chemical applications.

Construction Tube

Nitrile synthetic rubber, RMA Class A (High Oil Resistance)

Cover

Neoprene, RMA Class B (High Oil Resistance)

Reinforcement

One textile braid

Temperature Range

-65°F to 180°F (-54°C to 82°C)

Packaging

500' reels, maximum 3 pieces, 50' minimum length

Branding

Example: 9.5mm 3/8" Arctic Ortac® Continental ContiTech 2.1 MPa/300 psi. Made In U.S.A.

Couplings

Contact fitting manufacturer for proper fitting recommendation and coupling procedure.

Order Codes

536-276

Arctic Ortac®

SAP #	ID		Nom. OD		Max. WP		Weight	
	in.	mm	in.	mm	psi	MPa	lb./ft.	kg/m
20116761	1/4	6.4	0.63	16.0	300	2.07	0.14	0.21
20116614	3/8	9.5	0.75	19.1	300	2.07	0.19	0.28
20116762	1/2	12.7	0.91	23.1	300	2.07	0.25	0.37
20116615	3/4	19.1	1.18	30.0	300	2.07	0.36	0.54
20116763	1	25.4	1.50	38.1	300	2.07	0.58	0.86
20116617	1¼	31.8	1.80	45.7	300	2.07	0.74	1.10
20125302	1⅜	34.9	1.97	50.0	300	2.07	0.92	1.37
20116618	1½	38.1	2.09	53.1	300	2.07	1.01	1.50

Arctic Ortac® Plus



Product Specifications

Application

A low-temperature hose construction for air, water, oil, kerosene, fuel oil and some chemical operations where temperatures fall as low as -65°F (-54°C).

Construction Tube

Black low-temp, ECO oil-resistant synthetic rubber, RMA Class A (High Oil Resistance)

Cover

Black ultra-low temperature, ECO oil resistant synthetic rubber (with a blue stripe), RMA Class A (High Oil Resistance)

Reinforcement

One textile braid

Temperature Range

-65°F to 180°F (-54°C to 82°C)

Packaging

500' reels, maximum 3 pieces, 50' minimum length

Branding

Example: 9.5mm 3/8" Arctic Ortac® Plus 2.1 MPa/300 psi. Continental ContiTech. Made In U.S.A.

Couplings

Contact fitting manufacturer for proper fitting recommendation and coupling procedure.

Order Codes

536-275

Arctic Ortac® Plus

SAP #	ID		Nom. OD		Max. WP		Weight	
	in.	mm	in.	mm	psi	MPa	lb./ft.	kg/m
20159301	1/4	6.4	0.63	16.0	300	2.07	0.16	0.22
20159302	3/8	9.5	0.75	19.1	300	2.07	0.20	0.28
20159303	1/2	12.7	0.91	23.1	300	2.07	0.27	0.37
20159304	3/4	19.1	1.18	30.0	300	2.07	0.40	0.54
20146766	1	25.4	1.50	38.1	300	2.07	0.57	0.86

Air & Multipurpose
General Purpose
Heavy Duty
Push-on

Chemical Transfer

Cleaning Equipment

Food
Transfer
Washdown

Marine

Material Handling
Abrasives
Bulk Transfer
Cement & Concrete

Mining

Petroleum
Aircraft Fueling
Dispensing
Dock
Transfer

Spray

Steam

Vacuum

LPG Delivery

Water
Discharge
Suction & Discharge
Washdown

Welding

Coupling Systems

Equipment

Appendix

Flexsteel® Service Station Air



Air & Multipurpose
General Purpose
Heavy Duty
Push-on

Chemical Transfer

Cleaning Equipment

Food
Transfer
Washdown

Marine

Material Handling
Abrasives
Bulk Transfer
Cement & Concrete

Mining

Petroleum
Aircraft Fueling
Dispensing
Dock
Transfer

Spray

Steam

Vacuum

LPG Delivery

Water
Discharge
Suction & Discharge
Washdown

Welding

Coupling Systems

Equipment

Appendix

Product Specifications

Application

For tire inflation service from towers, reels or curb connections.

Construction Tube

Nitrile synthetic rubber, RMA Class B (Medium/High Oil Resistance)

Cover

Red or Black nitrile synthetic rubber, abrasion- and oil-resistant, RMA Class B (Medium/High Oil Resistance)

Reinforcement

Braided (1) steel wire braid

Temperature Range

-20°F to 190°F (-29°C to 88°C)

Packaging

500' reels, maximum 3 pieces, 25' minimum increments

Branding

Example: Continental ContiTech 1/4" Flexsteel® Service Station Air. Made in U.S.A.

Couplings

Contact fitting manufacturer for proper fitting recommendation and coupling procedure.

Order Codes

539-078 (red)
539-097 (black)

Flexsteel® Service Station Air

SAP #	ID		Nom. OD		Max. WP		Weight		
	Red	Black	in.	mm	in.	mm	psi	MPa	lb./ft.
20023487	20023860	1/4	6.4	0.61	15.5	250	1.72	0.18	0.28
20023492	20023865	3/8	9.5	0.72	18.3	250	1.72	0.23	0.34

Service Station Air

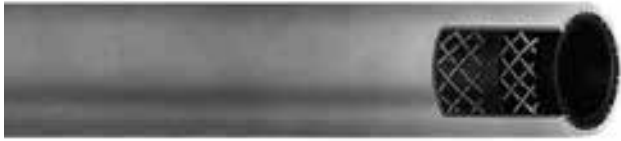

Air & Multipurpose
 General Purpose
 Heavy Duty
 Push-on

Product Specifications

Application

For general air line service stations, automobile repair shops, garages, etc.

Construction Tube

EPDM synthetic rubber, RMA Class C (Limited Oil Resistance)

Cover

EPDM synthetic rubber (red)

Reinforcement

Spiral synthetic yarn

Temperature Range

-40°F to 190°F (-40°C to 88°C)

Packaging

500' reels, maximum 3 pieces, 50' increments

Branding

Example: Service Station Air. Made in the U.S.A. Continental ContiTech

Couplings

Contact fitting manufacturer for proper fitting recommendation and coupling procedure.

Order Codes

569-018

Service Station Air

SAP #	ID		Nom. OD		Max. WP		Weight	
	in.	mm	in.	mm	psi	MPa	lb./ft.	kg/m
20026058	1/4	6.35	0.59	14.99	250	1.72	0.16	0.24
20026063	3/8	9.53	0.71	18.03	250	1.72	0.21	0.31

Chemical Transfer

Cleaning Equipment

Food
 Transfer
 Washdown

Marine

Material Handling
 Abrasives
 Bulk Transfer
 Cement & Concrete

Mining

Petroleum
 Aircraft Fueling
 Dispensing
 Dock
 Transfer

Spray

Steam

Vacuum

LPG Delivery

Water
 Discharge
 Suction & Discharge
 Washdown

Welding

Coupling Systems

Equipment

Appendix

Pliovic®



Air & Multipurpose
General Purpose
Heavy Duty
Push-on

Chemical Transfer

Cleaning Equipment

Food
Transfer
Washdown

Marine

Material Handling
Abrasives
Bulk Transfer
Cement & Concrete

Mining

Petroleum
Aircraft Fueling
Dispensing
Dock
Transfer

Spray

Steam

Vacuum

LPG Delivery

Water
Discharge
Suction & Discharge
Washdown

Welding

Coupling Systems

Equipment

Appendix

Product Specifications

Application

A lightweight, economical general purpose hose for carrying air, water and many spray solutions. Pliovic® is suitable for a wide range of industrial, construction, agricultural hand sprayers and many multipurpose applications. Non-conductive, minimum electrical resistance greater than one (1) megohm per inch of hose length at 1000 volts DC. Available in Pliovic® GS construction or a thick cover, Pliovic® Plus construction. Non-marking cover.

Construction Tube

Black Pliovic®, RMA Class B (Medium Oil Resistance)

Cover

Pliovic®, smooth finish, RMA Class B (Medium Oil Resistance)

Reinforcement

Spiral synthetic yarn

Temperature Range

-10°F to 158°F (-23°C to 70°C) for GS and Pliovic® Plus 250

Packaging

1/4"-1/2" - 750' reels, maximum 3 pieces, 50' increments
5/8" - 500' reels, maximum 3 pieces, 50' increments (Pliovic® Plus 250 Only)
3/4" - 450' reels, maximum 3 pieces, 50' increments (Pliovic® Plus 250 Only)

1" - 400' reels, maximum 3 pieces, 50' increments (Pliovic® Plus 250 Only)

1 1/4"-2" - 300' reels, maximum 3 pieces, 50' increments (Pliovic® Plus 250 Only)

Coupled assemblies available upon request. Contact hose marketing for availability on cut, coiled and tied hose lengths.

Branding

Example: Pliovic® GS 3/8" ID (9.5mm) 250 psi WP. Made in U.S.A. Continental ContiTech

Couplings

Contact fitting manufacturer for proper fitting recommendation and coupling procedure.

Order Codes

See next page.

Pliovic® GS

Order Codes: 540-350 (blue), 540-357 (yellow), 540-472 (black), 540-358 (green), 540-406 (red)

SAP #					ID		Nom. OD		Max. WP		Weight	
Blue	Red	Yellow	Black	Green	in.	mm	in.	mm	psi	MPa	lb./ft.	kg/m
20129505	20160220	20629533		20645372	1/4	6.4	0.45	11.4	300	2.07	0.06	0.09
20129506	20566773	20129502	20566772		5/16	7.9	0.59	15.0	300	2.07	0.11	0.16
20129507	20371442	20129503	20351772	20645373	3/8	9.5	0.60	15.2	300	2.07	0.09	0.13
20129508		20129504	20352500	20352636	1/2	12.7	0.78	19.8	300	2.07	0.15	0.22

Pliovic® Plus 250

Order Codes: 540-201 (red), 540-227 (blue), 540-232 (green), 540-233 (black), 540-257 (yellow)

SAP #					ID		Nom. OD		Max. WP		Weight	
Red	Blue	Green	Black	Yellow	in.	mm	in.	mm	psi	MPa	lb./ft.	kg/m
20012644	20012588	20012688	20012696	20012742	1/4	6.4	0.50	12.7	250	1.72	0.08	0.12
20012651	20012594	20012689	20012700	20012746	3/8	9.5	0.66	16.8	250	1.72	0.13	0.19
20012668	20012605	20012691	20012703	20012755	1/2	12.7	0.81	20.6	250	1.72	0.17	0.25
20012677	20012609	20012692	20012704	20753492	5/8	15.9	0.94	23.9	250	1.72	0.20	0.30
20012678	20012610	20012694	20012705	20012756	3/4	19.1	1.11	28.2	250	1.72	0.28	0.42
20012680	20012615	20012695	20012707	20012758	1	25.4	1.38	35.1	200	1.38	0.37	0.55

- Air & Multipurpose**
General Purpose
Heavy Duty
Push-on

- Chemical Transfer

- Cleaning Equipment

- Food**
Transfer
Washdown

- Marine

- Material Handling**
Abrasives
Bulk Transfer
Cement & Concrete

- Mining

- Petroleum**
Aircraft Fueling
Dispensing
Dock
Transfer

- Spray

- Steam

- Vacuum

- LPG Delivery

- Water**
Discharge
Suction & Discharge
Washdown

- Welding

- Coupling Systems

- Equipment

- Appendix

Braidair™



Air & Multipurpose
General Purpose
Heavy Duty
Push-on

Chemical Transfer

Cleaning Equipment

Food
Transfer
Washdown

Marine

Material Handling
Abrasives
Bulk Transfer
Cement & Concrete

Mining

Petroleum
Aircraft Fueling
Dispensing
Dock
Transfer

Spray

Steam

Vacuum

LPG Delivery

Water
Discharge
Suction & Discharge
Washdown

Welding

Coupling Systems

Equipment

Appendix

Product Specifications

Application

A quality braided general purpose hose for industrial service, compressor lines, pneumatic tools, water service and low-pressure spray where the need for oil resistance is moderate.

Construction Tube

Black synthetic, RMA Class A (High Oil Resistance)

Cover

Red synthetic, RMA Class B (Medium Oil Resistance)

Reinforcement

Braided (1) synthetic yarn

Temperature Range

-20°F to 190°F (-29°C to 88°C)

Packaging

1/4"-1" - 400-750' reels, maximum 3 pieces, 50' minimum

1¼"-1½" - 300' reels, maximum 3 pieces, 50' minimum
2" - 150-250' carton, maximum 2 pieces, 50' minimum

Branding

Example: Continental ContiTech Braidair™ 300 psi WP (20 Bar) 3/8" (9.5mm)

Couplings

Contact fitting manufacturer for proper fitting recommendation and coupling procedure.

Order Codes

536-422 (1/4" - 1½")
536-421 (2")

Braidair™

SAP #	ID		Nom. OD		Max. WP		Weight		
	Red	in.	mm	in.	mm	psi	MPa	lb./ft.	kg/m
20023152	1/4		6.4	0.55	14.0	300	2.07	0.11	0.16
20023157	3/8		9.5	0.72	18.3	300	2.07	0.18	0.26
20023161	1/2		12.7	0.85	21.6	300	2.07	0.21	0.31
20023163	3/4		19.1	1.13	28.7	300	2.07	0.32	0.48
20023166	1		25.4	1.47	37.3	300	2.07	0.50	0.74
20023168	1¼		31.8	1.80	45.7	300	2.07	0.75	1.12
20023169	1½		38.1	2.09	53.1	300	2.07	1.00	1.49
20023151	2		50.8	2.50	63.5	200	1.38	1.09	1.62

MIL A-A-59565 Military Air Hose



- Air & Multipurpose
 - General Purpose
 - Heavy Duty
 - Push-on
-
- Chemical Transfer
-
- Cleaning Equipment
-
- Food
 - Transfer
 - Washdown
-
- Marine
-
- Material Handling
 - Abrasives
 - Bulk Transfer
 - Cement & Concrete
-
- Mining
-
- Petroleum
 - Aircraft Fueling
 - Dispensing
 - Dock
 - Transfer
-
- Spray
-
- Steam
-
- Vacuum
-
- LPG Delivery
-
- Water
 - Discharge
 - Suction & Discharge
 - Washdown
-
- Welding
-
- Coupling Systems
-
- Equipment
-
- Appendix

Product Specifications

Application

This commercial item description (CID) covers rubber hose and rubber hose assemblies with yarn, cord or fabric reinforcement intended for light-duty air applications. The General Services Administration has authorized the use of this commercial item description for all federal agencies (5:1 Safety Factor).

Construction Tube

EPDM EPDM, RMA Class C Oil Resistance

Cover

EPDM EPDM, RMA Class C Oil Resistance

Reinforcement

2-spiral synthetic cord, 1/4" ID through 5/8" ID
 4-spiral synthetic cord, 3/4" ID through 1 1/4" ID

Temperature Range

-40°F to 190°F (-40°C to 88°C)

Packaging

Bulk reels (Alternative packaging specs available upon request)

Branding

Example: Pneumatic A-A-59565 Continental ContiTech 200 psi WP

Couplings

Contact fitting manufacturer for proper fitting recommendation and coupling procedure

Material Code

569-536

MIL A-A-59565 Military Air Hose

SAP #	Size	ID	Nom. OD		Max. WP		Weight		
Black	Code	in.	mm	in.	mm	psi	MPa	lb./ft.	kg/m
20026886	04	1/4	6.4	0.55	13.9	200	1.38	0.10	0.15
20026893	06	3/8	9.5	0.75	19.1	200	1.38	0.17	0.25
20697646	07	7/16	11.1	0.83	21.2	150	1.03	0.21	0.31
20026900	08	1/2	12.7	0.87	22.2	150	1.03	0.21	0.31
20100167	12	3/4	19.1	1.14	29.0	125	0.86	0.35	0.52
20026909	16	1	25.4	1.52	38.5	125	0.86	0.58	0.86

Heavy Duty



Air & Multipurpose
 General Purpose
 Heavy Duty
 Push-on

Chemical Transfer

Cleaning Equipment

Food
 Transfer
 Washdown

Marine

Material Handling
 Abrasives
 Bulk Transfer
 Cement & Concrete

Mining

Petroleum
 Aircraft Fueling
 Dispensing
 Dock
 Transfer

Spray

Steam

Vacuum

LPG Delivery

Water
 Discharge
 Suction & Discharge
 Washdown

Welding

Coupling Systems

Equipment

Appendix

	Page	MSHA	Oil Resistance Tube*	Oil Resistance Cover*	Temp. Range	Textile	Wire	Braided	Wrapped Finish
Crimped Jackhammer Assembly	34		C	C	-40°F to 190°F (-40°C to 88°C)		Yes		Yes
Plicord Air Green 400	33		C	C	-25°F to 180°F (-32°C to 82°C)	Yes			Yes
Plicord Super Rock Drill	32	Yes	A	B	-40°F to 220°F (-40°C to 104°C)		Yes		Yes
Prospector™ Air	30		C	C	-40°F to 220°F (-40°C to 104°C)	Yes		Yes	Yes
Prospector™ Plus Air	31		C	C	-40°F to 220°F (-40°C to 104°C)	Yes		Yes	Yes
Steel Air	28	Yes	B	B	-40°F to 200°F (-40°C to 93°C)		Yes	Yes	Yes
Super Ortac	29	Yes	B	B	-20°F to 212°F (-29°C to 100°C)		Yes	Yes	

*Based on RMA oil classification. For more information, see Appendix C.

Steel Air



Product Specifications

Application

A heavy-duty, wrapped finish, single wire-braid or spiral ply wire air hose for higher pressure service in severe industrial applications, including service in mines, quarries and construction jobs.

Construction Tube

Black Nitrile synthetic rubber, RMA Class B

Cover

Yellow Chemivac™ synthetic rubber (wrapped impression), RMA Class B, MSHA approved

Reinforcement

Braided (1) steel wire (1/2"-1 1/2"). Spiral-plied steel wire (2"-4")

Temperature Range

-40°F to 200°F (-40°C to 93°C)

Steel Air

Order Codes: 539-159 (1/2"-1 1/2"), MSHA 2G-IC-14C/38

SAP #	ID		Nom. OD		Max. WP		Weight	
	in.	mm	in.	mm	psi	MPa	lb./ft.	kg/m
20174720	1/2	12.7	0.91	23.1	750	5.17	0.34	0.51
20174724	3/4	19.1	1.14	29.0	750	5.17	0.45	0.67
20174775	1	25.4	1.45	36.6	750	5.17	0.66	1.00
20174776	1 1/4	31.8	1.81	46.0	500	3.45	0.98	1.46
20317183	1 1/2	38.1	1.98	50.2	500	3.45	0.97	1.44

Steel Air

Order Codes: 549-209 (2"-4"), MSHA IC 11/7

SAP #	ID		Nom. OD		Max. WP		Weight	
	in.	mm	in.	mm	psi	MPa	lb./ft.	kg/m
20316409	2	50.8	2.66	67.6	500	3.45	1.59	2.36
20317186	2 1/2	63.5	3.33	84.6	500	3.45	2.63	3.91
20316204	3	76.2	3.81	96.8	500	3.45	3.07	4.57

Also available with EPDM synthetic rubber tube and cover where superior heat resistance is more important than oil resistance.

Air & Multipurpose
General Purpose
Heavy Duty
Push-on

Chemical Transfer

Cleaning Equipment

Food
Transfer
Washdown

Marine

Material Handling
Abrasives
Bulk Transfer
Cement & Concrete

Mining

Petroleum
Aircraft Fueling
Dispensing
Dock
Transfer

Spray

Steam

Vacuum

LPG Delivery

Water
Discharge
Suction & Discharge
Washdown

Welding

Coupling Systems

Equipment

Appendix

Super Ortac®



Air & Multipurpose
General Purpose
Heavy Duty
Push-on



Chemical Transfer

Cleaning Equipment

Food
Transfer
Washdown

Marine

Material Handling
Abrasives
Bulk Transfer
Cement & Concrete

Mining

Petroleum
Aircraft Fueling
Dispensing
Dock
Transfer

Spray

Steam

Vacuum

LPG Delivery

Water
Discharge
Suction & Discharge
Washdown

Welding

Coupling Systems

Equipment

Appendix

Product Specifications

Application

For heavy-duty service in handling air, water, oil, petroleum-based solvents and agricultural spray solutions.

Construction Tube

Nitrile synthetic rubber, RMA Class B (Medium Oil Resistance)

Cover

Yellow Chemivic™ synthetic rubber, RMA Class B (Medium Oil Resistance), smooth finish, pinpricked, MSHA approved

Reinforcement

Braided (1) steel wire

Temperature Range

-20°F to 212°F (-29°C to 100°C)

Packaging

1/2"-1" - 500' reels, maximum 3 pieces, 50' increments

1¼"-1½" - 300' reels, maximum 3 pieces, 50' increments
2" - 100-200' per carton, maximum 3 pieces, 50' increments
Also stocked in cut and coiled 50' lengths, 2 pieces per carton, all sizes.

Branding

Example: Continental ContiTech 1" Super Ortac® 1000 psi. Fire Resistant USMSHA 2G-IC-14C/38. Made in U.S.A.

Couplings

See Continental ContiTech Hose Assembly Manual for most current crimp solutions.

Order Codes

539-152

Super Ortac®

SAP #	ID		Nom. OD		Max. WP		Weight	
	in.	mm	in.	mm	psi	MPa	lb./ft.	kg/m
20024051	1/2	12.7	0.91	23.1	1000	6.9	0.34	0.51
20024056	3/4	19.1	1.14	29.0	1000	6.9	0.44	0.65
20024066	1	25.4	1.45	36.8	1000	6.9	0.63	0.94
20024070	1¼	31.8	1.75	44.5	1000	6.9	0.86	1.28
20024074	1½	38.1	1.98	50.8	1000	6.9	1.08	1.61
20024077	2	50.8	2.55	64.3	1000	6.9	1.57	2.34

Prospector™ Air



Product Specifications

Application

A versatile, heavy-duty air hose for mining, construction and industrial applications.

Construction Tube

Black EPDM synthetic rubber, RMA Class C (Limited Oil Resistance) (536-509)

Black SBR synthetic rubber, RMA Class C (Limited Oil Resistance) (549-943)

Cover

Yellow EPDM synthetic rubber (wrapped impression), RMA Class C (Limited Oil Resistance)

Reinforcement

Braided (1) synthetic yarn (1/2"-2"); Spiral-plied synthetic fabric (2 1/2" - 3")

Temperature Range

-40°F to 220°F (-40°C to 104°C)

Packaging

50' length, coiled

Branding

Example: 1" 24.4mm Prospector™ Air 300 psi 2.1 MPa WP

Couplings

Contact fitting manufacturer for proper fitting recommendation and coupling procedure.

Order Codes

536 -509 (1/2"-1")

549-943 (1 1/4"-3")

Prospector™ Air

SAP #	ID		Nom. OD		Max. WP		Weight	
	in.	mm	in.	mm	psi	MPa	lb./ft.	kg/m
20070687	1/2	12.7	0.89	22.6	300	2.07	0.24	0.36
20070736	3/4	19.1	1.19	30.2	300	2.07	0.37	0.55
20070739	1	25.4	1.49	37.9	300	2.07	0.53	0.79
20020467	1 1/4	31.8	1.66	42.2	300	2.07	0.58	0.86
20020471	1 1/2	38.1	2.01	51.1	300	2.07	0.83	1.24
20020475	2	50.8	2.57	65.3	300	2.07	1.20	1.79
20130394	2 1/2	63.7	3.13	79.4	300	2.07	1.56	2.32
20020480	3	76.1	3.56	90.6	300	2.07	1.67	2.48

Air & Multipurpose
General Purpose
Heavy Duty
Push-on

Chemical Transfer

Cleaning Equipment

Food
Transfer
Washdown

Marine

Material Handling
Abrasives
Bulk Transfer
Cement & Concrete

Mining

Petroleum
Aircraft Fueling
Dispensing
Dock
Transfer

Spray

Steam

Vacuum

LPG Delivery

Water
Discharge
Suction & Discharge
Washdown

Welding

Coupling Systems

Equipment

Appendix

Prospector™ Plus Air



Air & Multipurpose
General Purpose
Heavy Duty
Push-on

Chemical Transfer

Cleaning Equipment

Food
Transfer
Washdown

Marine

Material Handling
Abrasives
Bulk Transfer
Cement & Concrete

Mining

Petroleum
Aircraft Fueling
Dispensing
Dock
Transfer

Spray

Steam

Vacuum

LPG Delivery

Water
Discharge
Suction & Discharge
Washdown

Welding

Coupling Systems

Equipment

Appendix

Product Specifications

Application

A versatile, heavy-duty air hose for mining, construction and industrial applications where medium pressures are encountered.

Construction Tube

Black EPDM synthetic rubber (536-508), RMA Class C
Black EPDM synthetic rubber (549-317)

Cover

Yellow EPDM (wrapped impression)

Reinforcement

Braided (1) synthetic yarn (1/2"-1 1/4"); Spiral-ply synthetic fabric (1 1/2"-4")

Temperature Range

-40°F to 220°F (-40°C to 104°C)

Packaging

50' length, coiled

Branding

Example: 1" 25.4mm Prospector™ Plus Air 400 psi 2.8 MPa WP. Continental ContiTech

Couplings

Contact fitting manufacturer for proper fitting recommendation and coupling procedure.

Order Codes

536-508 (1/2"-1")
549-317 (1 1/4"-4")

Prospector™ Plus Air

SAP #	ID	Nom. OD		Max. WP		Weight		
		in.	mm	in.	mm	psi	MPa	lb./ft.
20070685	1/2	12.7	0.94	23.9	400	2.76	0.24	0.36
20070734	3/4	19.1	1.19	30.2	400	2.76	0.38	0.57
20070738	1	25.4	1.49	37.9	400	2.76	0.54	0.80
20317200	1 1/4	31.8	1.66	42.2	400	2.76	0.56	0.83
20317201	1 1/2	38.1	2.01	51.1	400	2.76	0.83	1.24
20317204	2	50.8	2.54	64.4	400	2.76	1.08	1.61
20317223	2 1/2	63.5	3.17	80.6	400	2.76	1.70	2.53
20317210	3	76.2	3.66	93.0	400	2.76	2.00	2.98
20317214	4	101.6	4.78	121.5	400	2.76	2.92	4.35

Plicord® Super Rock Drill



- Air & Multipurpose**
 - General Purpose
 - Heavy Duty
 - Push-on
-
- Chemical Transfer
-
- Cleaning Equipment
-
- Food**
 - Transfer
 - Washdown
-
- Marine
-
- Material Handling**
 - Abrasives
 - Bulk Transfer
 - Cement & Concrete
-
- Mining
-
- Petroleum**
 - Aircraft Fueling
 - Dispensing
 - Dock
 - Transfer
-
- Spray
-
- Steam
-
- Vacuum
-
- LPG Delivery
-
- Water**
 - Discharge
 - Suction & Discharge
 - Washdown
-
- Welding
-
- Coupling Systems
-
- Equipment
-
- Appendix

Product Specifications

Application

An extra heavy-duty, high-pressure hose for pneumatic service in mining, construction and industrial service where working conditions are especially severe.

Construction Tube

Black, heat-resistant Nitrile (ORS) synthetic rubber, RMA Class A (High Oil Resistance)

Cover

Blue Chemivic™ synthetic with spiral yellow transfer stripe (wrapped impression) MSHA approved, RMA Class B (Medium Oil Resistance)

Reinforcement

Spiral-plied steel wire

Temperature Range

-40°F to 220°F (-40°C to 104°C)

Packaging

100' length, coiled, polywrapped

Branding (Spiral)

Example: Continental ContiTech Plicord® Super Rock Drill ORS 500 psi WP

Couplings

Contact fitting manufacturer for proper fitting recommendation and coupling procedure.

Order Codes

549-285

Plicord® Super Rock Drill

SAP #	ID		Nom. OD		Max. WP		Weight	
	in.	mm	in.	mm	psi	MPa	lb./ft.	kg/m
20316205	2½	63.5	3.45	87.7	500	3.45	2.96	4.40
	3	76.2	3.94	100.1	500	3.45	3.44	5.12
	4	101.6	4.96	126.0	400	2.76	4.55	6.77

Plicord® Air Green 400



Air & Multipurpose
General Purpose
Heavy Duty
Push-on



Chemical Transfer

Cleaning Equipment

Food
Transfer
Washdown

Marine

Material Handling
Abrasives
Bulk Transfer
Cement & Concrete

Mining

Petroleum
Aircraft Fueling
Dispensing
Dock
Transfer

Spray

Steam

Vacuum

LPG Delivery

Water
Discharge
Suction & Discharge
Washdown

Welding

Coupling Systems

Equipment

Appendix

Product Specifications

Application

A versatile, heavy-duty air hose for use in rough industrial applications or for severe service in mines, quarries and construction jobs.

Construction Tube

Black SBR synthetic rubber, RMA Class C (Limited Oil Resistance) (non-conductive)

Cover

Green SBR synthetic rubber (wrapped impression), RMA Class C (Limited Oil Resistance)

Reinforcement

Spiral-plied synthetic fabric

Temperature Range

-25°F to 180°F (-32°C to 82°C)

Packaging

100' length, coiled, polywrapped

Branding (Spiral)

Example: Continental ContiTech Plicord® Air Green 400 psi WP

Couplings

Contact fitting manufacturer for proper fitting recommendation and coupling procedure.

Order Codes

549-006

Plicord® Air Green 400

SAP #	ID		Nom. OD		Max. WP		Weight	
	in.	mm	in.	mm	psi	MPa	lb./ft.	kg/m
20018818	1/2	12.7	0.880	22.4	400	2.76	0.23	0.34
20018820	3/4	19.1	1.230	31.2	400	2.76	0.45	0.67
20018823	1	25.4	1.500	38.1	400	2.76	0.58	0.86
20159322	1¼	31.8	1.790	45.5	400	2.76	0.74	1.10
20018828	1½	38.1	2.040	51.8	400	2.76	0.86	1.28
20018830	2	50.8	2.546	64.7	400	2.76	1.11	1.65
20018831	2½	63.5	3.156	80.2	400	2.76	1.64	2.44
20018832	3	76.2	3.700	94.0	400	2.76	2.14	3.18

Crimped Jackhammer Assembly



Product Information

Application

An economical EPDM air hose available as factory made assemblies with high quality crimped universal couplings for jackhammer and other uses on construction sites. Available in 3/4" and 1", red and yellow at 200 PSI and 300 PSI, 4:1 safety factor.

Construction Tube

EPDM (RMA Class C)

Cover

EPDM (RMA Class C)

Reinforcement

Spiral Synthetic Yarn

Temperature Range

-40°F to 190°F (-40°C to 88°C)

Branding

3/4" (19.1 mm) 300 W.P. JACKHAMMER HOSE Made In USA

Working Pressure:

200 PSI and 300 PSI Maximum,
Please Note: Finished assembly is rated at 150 PSI for all sizes.

Crimped Jackhammer Assembly

SAP #		Length (ft.)	ID		Nom. OD		Max. WP	Weight
Red	Yellow		in.	mm	in.	mm	psi	lb./ft.
20749635		25	3/4	19.1	1.10	28.0	200	9.63
20665753	20715475	50	3/4	19.1	1.10	28.0	300	19.25
20749635		100	3/4	19.1	1.10	28.0	300	38.50
20665550		50	3/4	19.1	1.10	28.0	200	19.25
20415002		50	1	25.4	1.47	37.3	200	27.95
	20759549	50	1	25.4	1.47	37.3	300	33.60

Air & Multipurpose
General Purpose
Heavy Duty
Push-on

Chemical Transfer

Cleaning Equipment

Food
Transfer
Washdown

Marine

Material Handling
Abrasives
Bulk Transfer
Cement & Concrete

Mining

Petroleum
Aircraft Fueling
Dispensing
Dock
Transfer

Spray

Steam

Vacuum

LPG Delivery

Water
Discharge
Suction & Discharge
Washdown

Welding

Coupling Systems

Equipment

Appendix

Push-on



Air & Multipurpose
 General Purpose
 Heavy Duty
 Push-on

Chemical Transfer

Cleaning Equipment

Food
 Transfer
 Washdown

Marine

Material Handling
 Abrasives
 Bulk Transfer
 Cement & Concrete

Mining

Petroleum
 Aircraft Fueling
 Dispensing
 Dock
 Transfer

Spray

Steam

Vacuum

LPG Delivery

Water
 Discharge
 Suction & Discharge
 Washdown

Welding

Coupling Systems

Equipment

Appendix

	Page	Superior Abrasion Cover	MSHA	Non-conductive	Oil Resistance Tube*	Oil Resistance Cover*	Braided	Robotic Service	General Industrial
FLEXAGrip	39-40	Yes	Yes	Yes	A	A	Yes	Yes	Yes
Insta-Grip 250	37			Yes	A	B			Yes
Insta-Grip 300	36		Yes	Yes	A	B	Yes		Yes
Insta-Grip TC	38				A	B	Yes		Yes

*Based on RMA oil classification. For more information, see Appendix C.

Insta-Grip™ 300



Air & Multipurpose
 General Purpose
 Heavy Duty
 Push-on

Product Specifications

Application

For use with push-on fittings at working pressures of 300 psi. For low-pressure hydraulic and pneumatic systems such as shop air systems, general industrial, maintenance and automotive assembly applications. Non-conductive, minimum electrical resistance, greater than one (1) megohm per inch of hose length at 1000 volts DC. MSHA approved covers.

Construction Tube

Silicone is not used in the manufacturing of this hose. Chemivac™ oil and heat-resistant synthetic rubber, RMA Class A (High Oil Resistance)

Cover

Black, Green, Blue, Red, Yellow and Gray (others: contact customer service); MSHA approved, weather, abrasion and oil-resistant synthetic rubber. RMA Class B. (Medium Oil Resistance)

Reinforcement

Braided (1) high-strength synthetic yarn laid at the most effective angle for maximum strength and coupling holding ability

Temperature Range

-40°F to 190°F (-40°C to 88°C)

Packaging

500' reels, maximum 4 pieces, 10' minimum

Branding

Example: Insta-Grip™ 1/4" 300 psi WP Flame Resistant USMSHA 2G-IC-14C/33. Made in U.S.A. Continental ContiTech

Couplings

Contact fitting manufacturer for proper fitting recommendation and coupling procedure.

Order Codes

- 535-278 (black)
- 535-279 (green)
- 535-294 (gray)
- 535-280 (red)
- 535-281 (blue)
- 535-277 (yellow)

Insta-Grip™ 300

SAP #						ID	Nom. OD		Max. WP		Bend Radius Weight						
	Black	Green	Gray	Red	Blue		Yellow	in.	mm	in.	mm	psi	MPa	in.	mm	lb./ft.	kg/m
20474584						3/16	6.4	0.54	13.7	300	2.07	3	64	0.09	0.13		
20022636	20022656	20022816	20022666	20022677	20447145	1/4	4.8	0.38	9.7	300	2.07	3	64	0.05	0.07		
20022644	20022658	20022819	20022668	20022681	20447146	3/8	9.5	0.69	17.5	300	2.07	3	76	0.14	0.21		
20022648	20022661	20022823	20022671	20022684	20295159	1/2	12.7	0.81	20.6	300	2.07	5	127	0.17	0.25		
20022651	20022663	20022825	20022673	20022685		5/8	15.9	0.93	23.6	300	2.07	6	152	0.20	0.30		
20022653	20022664	20022826	20022674	20022686	20237027	3/4	19.1	1.07	27.2	300	2.07	7	178	0.26	0.39		

- Chemical Transfer
- Cleaning Equipment
- Food Transfer Washdown
- Marine
- Material Handling
 Abrasives
 Bulk Transfer
 Cement & Concrete
- Mining
- Petroleum
 Aircraft Fueling
 Dispensing
 Dock Transfer
- Spray
- Steam
- Vacuum
- LPG Delivery
- Water
 Discharge
 Suction & Discharge
 Washdown
- Welding
- Coupling Systems
- Equipment
- Appendix

Insta-Grip™ 250



Air & Multipurpose
General Purpose
Heavy Duty
Push-on



Chemical Transfer

Cleaning Equipment

Food
Transfer
Washdown

Marine

Material Handling
Abrasives
Bulk Transfer
Cement & Concrete

Mining

Petroleum
Aircraft Fueling
Dispensing
Dock
Transfer

Spray

Steam

Vacuum

LPG Delivery

Water
Discharge
Suction & Discharge
Washdown

Welding

Coupling Systems

Equipment

Appendix

Product Specifications

Application

For use with push-on fittings at working pressures of 250 psi for industrial service. Non-conductive, minimum electrical resistance greater than one (1) megohm per inch of hose length at 1000 volts DC.

Construction Tube

Chemivic™ oil- and heat-resistant synthetic rubber, RMA Class A (High Oil Resistance)

Cover

Red, Black, or Green Chemivic™, RMA Class B (Medium Oil Resistance)

Reinforcement

Spiral aramid yarn

Temperature Range

-20°F to 190°F (-29°C to 88°C)

Packaging

500' reels, maximum 3 pieces, 50' increments

Branding

Example: Insta-Grip™ Non-conductive 3/8" (9.5mm) 250 psi WP. Made in U.S.A. Continental ContiTech

Couplings

Contact fitting manufacturer for proper fitting recommendation and coupling procedure.

Order Codes

569-013 (red)
569-014 (black)
569-015 (green)
569-016 (gray)

Insta-Grip™ 250

SAP #	ID				Nom. OD				Max. WP		Weight	
	Red	Black	Green	Gray	in.	mm	in.	mm	psi	MPa	lb./ft.	kg/m
20025988	20026001	20026043	20160048	1/4	6.4	0.51	12.7	250	1.72	0.08	0.12	
20025994	20026012	20026046	20026055	3/8	9.5	0.65	16.5	250	1.72	0.12	0.18	
20025999	20026030	20026050	20026057	1/2	12.7	0.80	20.3	250	1.72	0.17	0.25	
20026035	20026035	20475077	20195088	5/8	15.9	0.94	23.9	250	1.72	0.23	0.34	
20026037	20026037		20195089	3/4	19.1	1.08	27.4	250	1.72	0.28	0.42	

Insta-Grip™ TC



Air & Multipurpose
 General Purpose
 Heavy Duty
 Push-on

Product Specifications

Application

For low-pressure hydraulic and pneumatic systems such as shop air systems, general industrial, maintenance and automotive assembly applications.

Construction Tube

Chemivic™ oil and heat-resistant synthetic rubber, RMA Class A (High Oil Resistance)

Cover

Black, dyed textile braid, mildew and oil-resistant

Reinforcement

Braided (1) high-strength synthetic yarn laid at an angle for strength and coupling holding ability

Temperature Range

-40°F to 190°F (-40°C to 88°C)

Packaging

500' reels, maximum 4 pieces, 10' minimum length

Branding

Example: Insta-Grip™ TC 3/8" 300 psi WP. Made in U.S.A. Continental ContiTech

Couplings

Contact fitting manufacturer for proper fitting recommendation and coupling procedure.

Order Codes

535-230

Insta-Grip™ TC

SAP #	ID		Nom. OD		Max. WP		Bend Radius		Weight	
	in.	mm	in.	mm	psi	MPa	in.	mm	lb./ft.	kg/m
20022593	1/4	6.4	0.50	12.7	300	2.07	3	64	0.08	0.12
20022595	5/16	7.9	0.56	14.2	300	2.07	3	76	0.09	0.13
20022597	3/8	9.5	0.64	16.3	300	2.07	3	76	0.11	0.16
20022600	1/2	12.7	0.75	19.1	300	2.07	5	127	0.13	0.19
20022602	5/8	15.9	0.91	23.1	300	2.07	6	152	0.19	0.28
20022604	3/4	19.1	1.03	26.2	300	2.07	7	178	0.21	0.31

- Chemical Transfer

- Cleaning Equipment

- Food**
Transfer
Washdown

- Marine

- Material Handling**
Abrasives
Bulk Transfer
Cement & Concrete

- Mining

- Petroleum**
Aircraft Fueling
Dispensing
Dock
Transfer

- Spray

- Steam

- Vacuum

- LPG Delivery

- Water**
Discharge
Suction & Discharge
Washdown

- Welding

- Coupling Systems

- Equipment

- Appendix

FLEXAGrip



Air & Multipurpose
General Purpose
Heavy Duty
Push-on

Chemical Transfer

Cleaning Equipment

Food
Transfer
Washdown

Marine

Material Handling
Abrasives
Bulk Transfer
Cement & Concrete

Mining

Petroleum
Aircraft Fueling
Dispensing
Dock
Transfer

Spray

Steam

Vacuum

LPG Delivery

Water
Discharge
Suction & Discharge
Washdown

Welding

Coupling Systems

Equipment

Appendix

Product Specifications

Application

For use with push-on fittings at maximum working pressures of 400 psi*. For low-pressure hydraulic pneumatic systems such as robotics, shop air systems, general industrial, maintenance and automotive assembly applications. Non-conductive, minimum electrical resistance greater than one (1) megohm per inch of hose length at 1000 volts DC. MSHA approved covers.

Construction Tube

Chemivic™ oil and heat-resistant synthetic rubber, RMA Class A (High Oil Resistance)

Cover

MSHA approved Black (USMSHA 2G-1C-14C/27). Blue, Gray, Green, Red, White, Brown and Yellow (USMSHA 2G-1C-14C/28) (others: contact customer service), weather, abrasion and oil-resistant Carbryn™ rubber, RMA Class A (High Oil Resistance)

Reinforcement

Braided (1) high-strength synthetic yarn laid at an angle for strength and coupling holding ability

Temperature Range

-40°F to 200°F (-40°C to 93°C)

Packaging

500' reels, maximum 4 pieces, 10' minimum length

Branding

Example: FLEXAGrip Non-conductive 3/8" 400 psi WP; Flame Resistant; USMSHA 2G-1C-14C/27. Made in U.S.A. Continental ContiTech

Couplings

Contact fitting manufacturer for proper fitting recommendation and coupling procedure.

Order Codes

535-283 (black)
535-284 (blue)
535-285 (gray)
535-286 (green)
535-289 (red)
535-290 (white)
535-292 (brown)
535-551 (yellow)

*1-inch rated at 300 psi.

FLEXAGrip

SAP #				ID		Nom. OD		Max. WP		Bend Radius		Weight	
Black	Blue	Gray	Green	in.	mm	in.	mm	psi	MPa	in.	mm	lb./ft.	kg/m
20022699				3/16	4.8	0.36	9.1	400	2.76	3	64	0.04	0.06
20022700	20022719	20022736	20022750	1/4	6.4	0.51	13.0	400	2.76	3	64	0.08	0.12
20022703	20022722	20022739	20022752	3/8	9.5	0.67	17.0	400	2.76	3	76	0.13	0.19
20022706	20022726	20022742	20022754	1/2	12.7	0.76	19.3	400	2.76	5	127	0.14	0.21
20022711	20022730	20022745	20022757	5/8	15.9	0.93	23.6	400	2.76	6	152	0.19	0.28
20022714	20022732	20022747	20022759	3/4	19.1	1.06	26.9	400	2.76	7	178	0.26	0.37
20141684	20146787	20148619	20146786	1	25.4	1.34	34.0	300	2.07	8	203	0.34	0.51

FLEXAGrip

SAP #				ID		Nom. OD		Max. WP		Bend Radius		Weight	
Red	White	Brown	Yellow	in.	mm	in.	mm	psi	MPa	in.	mm	lb./ft.	kg/m
				3/16	4.8	0.36	9.1	400	2.76	3	64	0.04	0.06
20022767	20022782	20022806	20022827	1/4	6.4	0.51	13.0	400	2.76	3	64	0.08	0.12
20022772	20022784	20022808	20022829	3/8	9.5	0.67	17.0	400	2.76	3	76	0.13	0.19
20022775	20022786	20022810	20022830	1/2	12.7	0.76	19.3	400	2.76	5	127	0.14	0.21
20022777			20022832	5/8	15.9	0.93	23.6	400	2.76	6	152	0.19	0.28
20022779	20022789	20022812	20022833	3/4	19.1	1.06	26.9	400	2.76	7	178	0.26	0.37
20112353				1	25.4	1.34	34.0	300	2.07	8	203	0.34	0.51

- Air & Multipurpose**
General Purpose
Heavy Duty
Push-on

- Chemical Transfer

- Cleaning Equipment

- Food**
Transfer
Washdown

- Marine

- Material Handling**
Abrasives
Bulk Transfer
Cement & Concrete

- Mining

- Petroleum**
Aircraft Fueling
Dispensing
Dock
Transfer

- Spray

- Steam

- Vacuum

- LPG Delivery

- Water**
Discharge
Suction & Discharge
Washdown

- Welding

- Coupling Systems

- Equipment

- Appendix

Notes

Air & Multipurpose

- General Purpose
- Heavy Duty
- Push-on

Chemical Transfer

Cleaning Equipment

Food

- Transfer
- Washdown

Marine

Material Handling

- Abrasives
- Bulk Transfer
- Cement & Concrete

Mining

Petroleum

- Aircraft Fueling
- Dispensing
- Dock
- Transfer

Spray

Steam

Vacuum

LPG Delivery

Water

- Discharge
- Suction & Discharge
- Washdown

Welding

Coupling Systems

Equipment

Appendix

Chemical Transfer



	Page	Temp. Range*	Superior Flexibility	Superior Abrasion Cover	Cover Color
Brown Flexwing	47	-30°F to 275°F (-34°C to 135°C)			Brown
Blue Flexwing	53	-25°F to 150°F (-32°C to 66°C)			Blue
Chem One	43	-40°F to 250°F (-40°C to 121°C)	Yes	Yes	Black
DEF Transfer Hose	44	-40°F to 257°F (-40°C to 125°C)			Black
Fabchem	46	-40°F to 150°F (-40°C to 66°C)	Yes		Green
Green XLPE	42	-25°F to 150°F (-32°C to 66°C)			Green
HI-PER	48	-40°F to 300°F (-40°C to 149°C)			Blue
Orange Flexwing	49	-25°F to 250°F (-32°C to 121°C)			Orange
Plicord ExtremeFlex Brown	51	-30°F to 275°F (-34°C to 135°C)	Yes		Brown
Plicord ExtremeFlex Purple	52	-40°F to 221°F (-40°C to 105°C)	Yes		Purple
Purple Flexwing	50	-40°F to 221°F (-40°C to 105°C)			Purple
Viper	45	-40°F to 250°F (-40°C to 121°C)	Yes	Yes	Black

*Temperature is contingent on the specific chemical conveyed.

Air & Multipurpose
 General Purpose
 Heavy Duty
 Push-on

Chemical Transfer

Cleaning Equipment

Food
 Transfer
 Washdown

Marine

Material Handling
 Abrasives
 Bulk Transfer
 Cement & Concrete

Mining

Petroleum
 Aircraft Fueling
 Dispensing
 Dock
 Transfer

Spray

Steam

Vacuum

LPG Delivery

Water
 Discharge
 Suction & Discharge
 Washdown

Welding

Coupling Systems

Equipment

Appendix

Green XLPE Cross Link Polyethylene



Air & Multipurpose
 General Purpose
 Heavy Duty
 Push-on

Chemical Transfer

Cleaning Equipment

Food
 Transfer
 Washdown

Marine

Material Handling
 Abrasives
 Bulk Transfer
 Cement & Concrete

Mining

Petroleum
 Aircraft Fueling
 Dispensing
 Dock
 Transfer

Spray

Steam

Vacuum

LPG Delivery

Water
 Discharge
 Suction & Discharge
 Washdown

Welding

Coupling Systems

Equipment

Appendix

Product Specifications

Application

Handles the majority of today's industrial chemicals in pressure, gravity flow or suction service.

Construction Tube

Clear Specplar® synthetic rubber Cross-Linked Polyethylene (XLPE)

Cover

Green EPDM synthetic rubber with spiral white stripe (wrapped impression)

Reinforcement

Spiral-plied synthetic fabric with double wire helix

Temperature Range

-25°F to 150°F (-32°C to 66°C)

Packaging

100' exact length, coiled, polywrapped

Branding (Spiral)

Example: Continental ContiTech XLPE Chemical Transfer 150 psi

Couplings

Use Continental ContiTech Insta-Lock™ Cam & Groove Fittings with this product. See the Coupling Systems information pages at the back of the catalog.

Order Codes

546-666 (1/2"-4")
 541-666 (6")

Green XLPE

SAP #	ID	Nom. OD		Max. WP		Bend Radius		Vacuum HG		Weight		
Green	in.	mm	in.	mm	psi	MPa	in.	mm	in.	mm	lb./ft.	kg/m
20018685	1/2	12.7	0.97	24.6	150	1.03	6	152	29	737	0.31	0.46
20018688	3/4	19.1	1.23	31.2	150	1.03	7	178	29	737	0.44	0.65
20018690	1	25.4	1.47	37.3	150	1.03	8	203	29	737	0.54	0.80
20018694	1¼	31.8	1.73	43.9	150	1.03	9	229	29	737	0.66	0.98
20018697	1½	38.1	2.03	51.6	150	1.03	10	254	29	737	0.92	1.37
20018700	2	50.8	2.61	66.3	150	1.03	12	305	29	737	1.32	1.96
20018704	2½	63.5	3.11	79.0	150	1.03	15	381	29	737	1.65	2.46
20018707	3	76.2	3.61	91.7	150	1.03	18	457	29	737	2.02	3.01
20018709	4	101.6	4.69	119.1	150	1.03	24	610	29	737	2.95	4.39
20706595	6	152.4	6.86	174.1	150	1.03	36	900	29	737	6.07	9.04

Note: Refer to the Continental ContiTech Chemical Resistance Charts pages in Appendix B for specific chemical and temperature compatibility.

Chem One™



Product Specifications

Application

For the transfer of a variety of current industrial chemicals used today. (Refer to Continental ContiTech Chemical Resistance Guide for compatibility.) For use in pressure, gravity flow and/or suction service.

Construction Tube

Alphasyn® Modified Cross-Linked Polyethylene (Mod XLPE)

Cover

Black corrugated abrasion-resistant Omegasyn™ EPDM with Red Spiral Stripe

Reinforcement

Spiral-plied synthetic fabric with double wire helix

Temperature Range

-40°F to 250°F (-40°C to 121°C)

Packaging

Coiled and polywrapped. Contact customer service for cut length.

Branding

Example: Chem One™ chemical transfer hose Alphasyn® 200 psi WP. Continental ContiTech

Couplings

Use Continental ContiTech Insta-Lock™ Cam & Groove Fittings with this product.

Order Codes

546-590 ARC Cover

546-661 Black EPDM Cover

Chem One™

SAP #	ID	Nom. OD		Max. WP		Bend Radius		Vacuum HG		Weight		
		in.	mm	in.	mm	in.	mm	in.	mm	lb./ft.	kg/m	
20408836	3/4	19.0	1.2	30.5	200	1.38	2	50.8	29	737	0.39	0.58
20408837	1	25.3	1.4	36.8	200	1.38	3	76.2	29	737	0.49	0.73
20408838	1¼	32.0	1.6	42.2	200	1.38	3	76.2	29	737	0.53	0.78
20408870	1½	38.0	1.9	48.3	200	1.38	4	101.6	29	737	0.63	0.93
20408871	2	51.0	2.4	61.8	200	1.38	5	127.0	29	737	0.86	1.28
20408872	2½	63.0	2.9	75.6	200	1.38	6	152.4	29	737	1.24	1.84
20408873	3	76.0	3.4	88.1	200	1.38	8	203.2	29	737	1.46	2.17
20408813	4	102.0	4.5	115.0	200	1.38	11	279.4	29	737	2.06	3.06



Air & Multipurpose
 General Purpose
 Heavy Duty
 Push-on

Chemical Transfer

Cleaning Equipment

Food
 Transfer
 Washdown

Marine

Material Handling
 Abrasives
 Bulk Transfer
 Cement & Concrete

Mining

Petroleum
 Aircraft Fueling
 Dispensing
 Dock
 Transfer

Spray

Steam

Vacuum

LPG Delivery

Water
 Discharge
 Suction & Discharge
 Washdown

Welding

Coupling Systems

Equipment

Appendix

DEF Transfer Hose



Air & Multipurpose
 General Purpose
 Heavy Duty
 Push-on

Chemical Transfer

Cleaning Equipment

Food
 Transfer
 Washdown

Marine

Material Handling
 Abrasives
 Bulk Transfer
 Cement & Concrete

Mining

Petroleum
 Aircraft Fueling
 Dispensing
 Dock
 Transfer

Spray

Steam

Vacuum

LPG Delivery

Water
 Discharge
 Suction & Discharge
 Washdown

Welding

Coupling Systems

Equipment

Appendix

Product Specifications

Application

Continental DEF Dispensing Hose is specifically designed to convey the high-purity, aqueous urea solution DEF.

Packaging

100 ft lengths

Construction Tube

Pliosyn™ Ultra-High Molecular Weight Polyethylene (UHMWPE) with proprietary backing. Tube tested per iso 22241-2 immersion test at independent lab to confirm compatibility with DEF aqueous solution.

Branding

Example: Continental ContiTech DEF Transfer Hose 3/4" (19.1mm), Continental ContiTech DEF Transfer Hose (Date Code) Made in Canada

Cover

Black corrugated EPDM

Couplings

Contact fitting manufacturer for proper fitting recommendation.

Reinforcement

Spiral-plied synthetic fabric with double wire helix

Order Codes

546-552

Temperature Range

-40°F to 140°F (-40°C to 60°C)

DEF Transfer Hose

Features	Benefits
Enhanced manufacturing practices	Significantly reduces contamination that can clog an SCR system and stop a truck
Premium braided construction	Reduced volumetric expansion to meet Weights and Measures system criteria
Static Wire	Requirement for installations in Class I, Division 1 areas as outlined in NFPA 70
Meets ISO 22241 standard	Ensures desirable characteristics of AUS 32 (DEF) are met, such as quality, safety, reliability and contamination

DEF Transfer Hose

SAP #	ID	Nom. OD		Max. WP	Bend Radius		Vacuum HG		Weight		
		in.	mm		in.	mm	in.	mm	lb./ft.	kg/m	
20741106	1	25.4	1.45	37.3	250	4	102	29	737	0.42	0.89
20738416	1½	38.1	1.97	50	250	5	127	29	737	0.84	1.25
20738464	2	50.8	2.55	64.8	250	6	152	29	737	1.22	1.82
20738465	3	76.2	3.63	92.2	250	9	229	29	737	2.11	3.14

*Alternate packaging specs available upon request

Viper™



Product Specifications

Application

For the transfer of a variety of industrial chemicals used today. (Refer to Continental ContiTech Chemical Resistance Guide for compatibility.) For use in pressure, gravity flow and/or suction service. Hose may be cleaned using open-end steam up to 50 psi or in a bath containing 10% Sodium Hydroxide (NaOH), up to 212°F (100°C).

Construction Tube

Beige Alphasyn® Modified Cross-Linked Polyethylene (Modified XLPE)

Cover

Black Omegasyn™ abrasion-resistant EPDM with white spiral stripe

Reinforcement

Spiral-plied synthetic fabric with double wire helix

Temperature Range

-40°F to 250°F (-40°C to 121°C)

Packaging

100' length coiled, polywrapped

Branding (Spiral)

Example: Continental ContiTech Viper™ Chemical Transfer Alphasyn® 200 psi WP

Couplings

Fittings should be permanently attached for fluid temperatures above 125°F (52°C) and up to 250°F (121°C). Use Continental ContiTech Insta-Lock™ Cam & Groove Fittings with this product. See the Couplings Systems information pages at the back of the catalog.

Order Codes

546-345

Viper™

SAP #	ID		Nom. OD		Max. WP		Bend Radius		Vacuum HG		Weight	
	in.	mm	in.	mm	psi	MPa	in.	mm	in.	mm	lb./ft.	kg/m
20106813	1	25.4	1.45	36.9	200	1.38	4	100	29	737	0.53	0.79
20091802	1½	38.1	1.95	49.6	200	1.38	5	125	29	737	0.74	1.10
20091803	2	50.8	2.54	64.5	200	1.38	7	175	29	737	1.16	1.73
20069573	2½	63.5	3.05	77.5	200	1.38	8	200	29	737	1.41	2.10
20091805	3	76.2	3.59	91.2	200	1.38	10	250	29	737	1.82	2.71
20123987	4	101.6	4.64	117.8	200	1.38	14	350	29	737	2.42	3.61

Note: Refer to the Continental ContiTech Chemical Resistance Charts pages in Appendix B for specific chemical and temperature compatibility.

Viper™ chemical hose will handle fluid up to 250°F (121°C), however, this rating is contingent on the specific chemical conveyed. Contact Customer Service at 1-800-235-4632 for any chemical above the temperature stated in the Continental ContiTech Chemical Resistance Guide. Refer to the Continental ContiTech Chemical Resistance Chart for Specific Chemical and Temperature Compatibility.

Air & Multipurpose
General Purpose
Heavy Duty
Push-on

Chemical Transfer

Cleaning Equipment

Food
Transfer
Washdown

Marine

Material Handling
Abrasives
Bulk Transfer
Cement & Concrete

Mining

Petroleum
Aircraft Fueling
Dispensing
Dock
Transfer

Spray

Steam

Vacuum

LPG Delivery

Water
Discharge
Suction & Discharge
Washdown

Welding

Coupling Systems

Equipment

Appendix

Fabchem™ Pliosyn™ (UHMWPE) Tube



Air & Multipurpose
 General Purpose
 Heavy Duty
 Push-on

Chemical Transfer

Cleaning Equipment

Food
 Transfer
 Washdown

Marine

Material Handling
 Abrasives
 Bulk Transfer
 Cement & Concrete

Mining

Petroleum
 Aircraft Fueling
 Dispensing
 Dock
 Transfer

Spray

Steam

Vacuum

LPG Delivery

Water
 Discharge
 Suction & Discharge
 Washdown

Welding

Coupling Systems

Equipment

Appendix

Product Specifications

Application

A significant improvement to our chemical hose line. It handles the majority of common industrial chemicals in pressure, gravity flow and suction service.

Construction Tube

Pliosyn™ Ultra-High Molecular Weight Polyethylene (UHMWPE)

Cover

Green EPDM synthetic rubber with bright orange longitudinal stripe, corrugated (wrapped impression)

Reinforcement

Spiral-plied synthetic fabric with double wire helix

Temperature Range

-40°F to 150°F (-40°C to 66°C)

Packaging

100' exact length, coiled, polywrapped

Branding (Spiral)

Example: Continental ContiTech Fabchem™ Chemical Transfer Hose, 200 psi WP

Couplings

Use Continental ContiTech Insta-Lock™ Cam & Groove Fittings with this product. See the Coupling Systems information pages at the back of the catalog.

Order Codes

546-065 Green Cover, 546-533 Purple Cover

Fabchem™ Pliosyn™ (UHMWPE) Tube

SAP #	ID			Nom. OD		Max. WP		Bend Radius		Vacuum HG		Weight			
	Green	Purple	Blue	in.	mm	in.	mm	psi	MPa	in.	mm	in.	mm	lb./ft.	kg/m
20018477		20617876		1/2	12.7	0.95	24.1	200	1.38	3	76	29	737	0.33	0.49
20018478		20617877		3/4	19.1	1.22	31.0	200	1.38	4	89	29	737	0.46	0.68
20018481	20673999	20243623		1	25.4	1.47	37.3	200	1.38	4	102	29	737	0.60	0.89
20018485				1¼	31.8	1.73	43.9	200	1.38	4	102	29	737	0.73	1.09
20018488	20674040	20385256		1½	38.1	1.97	50.0	200	1.38	5	127	29	737	0.84	1.25
20018493	20674041	20598926		2	50.8	2.55	64.8	200	1.38	6	152	29	737	1.22	1.82
20018496				2½	63.5	3.14	79.8	200	1.38	8	203	29	737	1.78	2.65
20018498				3	76.2	3.63	92.2	200	1.38	9	229	29	737	2.11	3.14
20018502				4	101.6	4.67	118.6	200	1.38	10	254	29	737	2.81	4.18
		20579508		6	152.4	6.88	175	200	1.38	18	457	29	737	5.98	8.90

Note: Refer to the Continental ContiTech Chemical Resistance Charts pages in Appendix B for specific chemical and temperature compatibility.

Brown Flexwing® Chemrin® (CPE) Tube



Product Specifications

Application

A versatile chemical hose capable of handling a wide variety of acids, alcohols, salt solutions and petroleum-based products.

Construction Tube

Black Chemrin® synthetic rubber

Cover

Brown EPDM synthetic rubber with white spiral brand (wrapped impression)

Reinforcement

Spiral-plied synthetic fabric with double wire helix

Temperature Range

-30°F to 275°F (-34°C to 135°C)

Packaging

100' exact length, coiled, polywrapped

Branding (Spiral)

Example: Continental ContiTech Brown Flexwing® with Chemrin® 150 psi WP

Couplings

Use Continental ContiTech Insta-Lock™ Cam & Groove Fittings with this product. See the Coupling Systems information pages at the back of the catalog.

Order Codes

546-069

541-069 (Custom lengths with fittings.)

Brown Flexwing®

SAP #	ID	Nom. OD		Max. WP		Bend Radius		Vacuum HG		Weight		
		in.	mm	in.	mm	in.	mm	in.	mm	lb./ft.	kg/m	
20018560	3/4	19.1	1.22	31.0	150	1.03	3	76	29	737	0.45	0.67
20018561	1	25.4	1.47	37.3	150	1.03	4	89	29	737	0.57	0.85
20018567	1¼	31.8	1.73	43.9	150	1.03	4	102	29	737	0.69	1.03
20018569	1½	38.1	2.02	51.3	150	1.03	4	102	29	737	0.95	1.41
20018571	2	50.8	2.55	64.8	150	1.03	5	127	29	737	1.26	1.88
20263622	2½	63.5	3.09	78.5	150	1.03	6	152	29	737	1.71	2.54
20018573	3	76.2	3.61	91.7	150	1.03	7	178	29	737	2.11	3.14
20018574	4	101.6	4.69	119.1	150	1.03	10	254	29	737	3.04	4.52
20014953	6	152.4	6.91	175.5	150	1.03	30	762	29	737	6.32	9.41

Note: Refer to the Continental ContiTech Chemical Resistance Charts pages in Appendix B for specific chemical and temperature compatibility.

Air & Multipurpose

General Purpose
Heavy Duty
Push-on

Chemical Transfer

Cleaning Equipment

Food

Transfer
Washdown

Marine

Material Handling

Abrasives
Bulk Transfer
Cement & Concrete

Mining

Petroleum

Aircraft Fueling
Dispensing
Dock
Transfer

Spray

Steam

Vacuum

LPG Delivery

Water

Discharge
Suction & Discharge
Washdown

Welding

Coupling Systems

Equipment

Appendix

Hi-Per®



Air & Multipurpose
 General Purpose
 Heavy Duty
 Push-on

Chemical Transfer

Cleaning Equipment

Food
 Transfer
 Washdown

Marine

Material Handling
 Abrasives
 Bulk Transfer
 Cement & Concrete

Mining

Petroleum
 Aircraft Fueling
 Dispensing
 Dock
 Transfer

Spray

Steam

Vacuum

LPG Delivery

Water
 Discharge
 Suction & Discharge
 Washdown

Welding

Coupling Systems

Equipment

Appendix

Product Specifications

Application

A premium hose which is FEP lined to handle a broad spectrum of fluids and materials in a wide variety of applications.

Construction Tube

FEP has FDA/USDA compliant materials

Cover

Blue EPDM synthetic rubber with bright orange spiral transfer tape (wrapped impression)

Reinforcement

Spiral-plied synthetic fabric with double wire helix

Temperature Range

-40°F to 300°F (-40°C to 149°C)

Packaging

Custom lengths available (minimum 5')

Branding (Spiral)

Example: Continental ContiTech Hi-Per® Universal Chemical Hose FEP lined

Couplings

Use Continental ContiTech Insta-Lock™ Cam & Groove Fittings with this product. See the Coupling Systems information pages at the back of the catalog.

Non-Stock/Sizes

Order in increments of 100' for 1/2"-2"

Order in increments of 60' for 2½" and larger sizes

Order Codes

546-256

Hi-Per®

SAP #	ID	Nom. OD		Max. WP		Bend Radius		Vacuum HG		Weight		
Blue	in.	mm	in.	mm	psi	MPa	in.	mm	in.	mm	lb./ft.	kg/m
20018637	1/2	12.7	0.97	24.6	200	1.38	3	76	29	737	0.37	0.55
20018639	3/4	19.1	1.11	28.2	200	1.38	5	127	29	737	0.56	0.83
20018642	1	25.4	1.52	38.6	200	1.38	8	191	29	737	0.71	1.06
20018644	1¼	31.8	1.73	43.9	200	1.38	11	279	29	737	0.84	1.25
20018647	1½	38.1	2.13	54.1	200	1.38	14	356	29	737	1.24	1.85
20018650	2	50.8	2.69	68.3	200	1.38	18	457	29	737	1.71	2.54
20157471	3	76.2	3.67	93.2	200	1.38	35	889	29	737	2.52	3.75

Note: Refer to the Continental ContiTech Chemical Resistance Charts pages in Appendix B for specific chemical and temperature compatibility.

Orange Flexwing® Flosyn® Tube



Product Specifications

Application

A versatile chemical hose capable of handling a wide variety of acids, alcohols, salt solutions and petroleum-based products.

Construction Tube

Black Flosyn® synthetic rubber

Cover

Orange Chemivic™ synthetic rubber with white spiral brand (wrapped impression)

Reinforcement

Spiral-plied synthetic fabric with double wire helix

Temperature Range

-25°F to 250°F (-32°C to 121°C)

Packaging

100' exact length, coiled, polywrapped

Branding (Spiral)

Example: Continental ContiTech Orange Flexwing® with Flosyn® 150 psi WP

Couplings

Use Continental ContiTech Insta-Lock™ Cam & Groove Fittings with this product. See the Coupling Systems information pages at the back of the catalog.

Non-Stock/Sizes

Order in increments of 100'

Order Codes

541-063

Orange Flexwing®

SAP #	ID	Nom. OD		Max. WP		Bend Radius		Vacuum HG		Weight		
		in.	mm	in.	mm	in.	mm	in.	mm	lb./ft.	kg/m	
20014912	1	25.4	1.44	36.6	150	1.03	4	89	29	737	0.61	0.91
20014913	1¼	31.8	1.73	43.9	150	1.03	4	102	29	737	0.79	1.18
20014915	1½	38.1	1.97	50.0	150	1.03	4	102	29	737	0.95	1.41
20014917	2	50.8	2.58	65.5	150	1.03	5	127	29	737	1.45	2.16
20014918	2½	63.5	3.08	78.2	150	1.03	6	152	29	737	1.77	2.63
20014919	3	76.2	3.59	91.2	150	1.03	7	178	29	737	2.26	3.36
20014921	4	101.6	4.69	119.1	150	1.03	10	254	29	737	3.31	4.93
20131037	6	152.4	6.81	173.0	150	1.03	30	762	29	737	6.29	9.36

Note: Refer to the Continental ContiTech Chemical Resistance Charts pages in Appendix B for specific chemical and temperature compatibility.

Air & Multipurpose
General Purpose
Heavy Duty
Push-on

Chemical Transfer

Cleaning Equipment

Food
Transfer
Washdown

Marine

Material Handling
Abrasives
Bulk Transfer
Cement & Concrete

Mining

Petroleum
Aircraft Fueling
Dispensing
Dock
Transfer

Spray

Steam

Vacuum

LPG Delivery

Water
Discharge
Suction & Discharge
Washdown

Welding

Coupling Systems

Equipment

Appendix

Purple Flexwing®



Air & Multipurpose
 General Purpose
 Heavy Duty
 Push-on

Chemical Transfer

Cleaning Equipment

Food
 Transfer
 Washdown

Marine

Material Handling
 Abrasives
 Bulk Transfer
 Cement & Concrete

Mining

Petroleum
 Aircraft Fueling
 Dispensing
 Dock
 Transfer

Spray

Steam

Vacuum

LPG Delivery

Water
 Discharge
 Suction & Discharge
 Washdown

Welding

Coupling Systems

Equipment

Appendix

Product Specifications

Application

A versatile hose developed to handle a wide range of chemicals, acids and alcohols in both suction and discharge service.

Construction Tube

Black EPDM synthetic rubber

Cover

Purple EPDM with yellow spiral brand (wrapped impression)

Reinforcement

Spiral-plied synthetic fabric with double wire helix

Temperature Range

-40°F to 221°F (-40°C to 104°C)

Packaging

100' exact length, coiled, polywrapped

Branding (Spiral)

Example: Continental ContiTech Purple Flexwing® with EPDM 150 psi Max WP

Couplings

Use Continental ContiTech Insta-Lock™ Cam & Groove Fittings with this product. See the Coupling Systems information pages at the back of the catalog.

Order Codes

546-805

Purple Flexwing®

SAP #	ID		Nom. OD		Max. WP		Bend Radius		Vacuum HG		Weight		
	Purple	in.	mm	in.	mm	psi	MPa	in.	mm	in.	mm	lb./ft.	kg/m
20018743	1½		38.1	2.02	51.3	150	1.03	4	102	29	737	0.95	1.41
20018749	2		50.8	2.53	64.3	150	1.03	5	127	29	737	1.16	1.73
20018750	3		76.2	3.58	90.9	150	1.03	7	178	29	737	2.00	2.98
20018751	4		101.6	4.69	119.1	150	1.03	10	254	29	737	3.03	4.51

Note: Refer to the Continental ContiTech Chemical Resistance Charts pages in Appendix B for specific chemical and temperature compatibility.

Plicord® ExtremeFlex™ Brown



Product Specifications

Application

A high-tech, flexible and versatile chemical hose capable of handling a wide variety of acids, alcohols, salt solutions and petroleum-based products.

Construction Tube

Black Chemrin® (CPE) synthetic rubber

Cover

Corrugated Brown EPDM synthetic rubber with white spiral stripe

Reinforcement

Spiral-plied synthetic fabric with double wire helix

Temperature Range

-30°F to 275°F (-34°C to 135°C)

Packaging

100' exact cut length, coiled, polywrapped

Branding (Spiral)

Example: Continental ContiTech Plicord® ExtremeFlex™ Brown w/ Chemrin® 150 psi. Made In Canada

Couplings

Use Continental ContiTech Insta-Lock™ Cam & Groove Fittings with the product. See the Coupling Systems information pages at the back of the catalog.

Non-Stock/Sizes

400' minimum if not stocked.

Order Codes

546-723

Plicord® ExtremeFlex™ Brown

SAP #	ID	Nom. OD		Max. WP		Bend Radius		Vacuum HG		Weight		
		in.	mm	in.	mm	psi	MPa	in.	mm	in.	mm	lb./ft.
20524365	1	25.30	1.42	36.00	150	1.03	1.50	38.10	29	737	0.50	0.75
20524366	1¼	32.00	1.63	41.50	150	1.03	2.00	50.80	29	737	0.57	0.85
20668438	1½	38.00	1.92	48.70	150	1.03	2.25	57.20	29	737	0.74	1.10
20524368	2	51.20	2.44	61.90	150	1.03	3.00	76.00	29	737	0.97	1.45
20524369	3	76.20	3.54	89.80	150	1.03	4.50	114.00	29	737	1.80	2.68
20524381	4	102.10	4.57	116.10	150	1.03	6.00	152.00	29	737	2.47	3.68



Air & Multipurpose
General Purpose
Heavy Duty
Push-on

Chemical Transfer

Cleaning Equipment

Food
Transfer
Washdown

Marine

Material Handling
Abrasives
Bulk Transfer
Cement & Concrete

Mining

Petroleum
Aircraft Fueling
Dispensing
Dock
Transfer

Spray

Steam

Vacuum

LPG Delivery

Water
Discharge
Suction & Discharge
Washdown

Welding

Coupling Systems

Equipment

Appendix

Plicord® ExtremeFlex™ Purple



Air & Multipurpose

- General Purpose
- Heavy Duty
- Push-on

Chemical Transfer

Cleaning Equipment

- Food Transfer
- Washdown

Marine

Material Handling

- Abrasives
- Bulk Transfer
- Cement & Concrete

Mining

Petroleum

- Aircraft Fueling
- Dispensing
- Dock Transfer

Spray

Steam

Vacuum

LPG Delivery

Water

- Discharge
- Suction & Discharge
- Washdown

Welding

Coupling Systems

Equipment

Appendix

Product Specifications

Application

A high-tech, flexible and versatile chemical hose capable of handling a wide range of chemicals, acids and alcohols in both suction and discharge service.

Construction Tube

Black EPDM synthetic rubber

Cover

Corrugated Purple EPDM synthetic rubber with yellow spiral stripe

Reinforcement

Spiral-plied synthetic fabric with double wire helix

Temperature Range

-40°F to 221°F (-40°C to 104°C)

Packaging

100' exact cut length, coiled, polywrapped

Branding (Spiral)

Example: Continental ContiTech Plicord® ExtremeFlex™ Purple 150 psi. Made In Canada

Couplings

Use Continental ContiTech Insta-Lock™ Cam & Groove Fittings with the product. See the Coupling Systems information pages at the back of the catalog.

Non-Stock/Sizes

400' minimum if not stocked.

Order Codes

546-721

Plicord® ExtremeFlex™ Purple

SAP #	ID	Nom. OD		Max. WP		Bend Radius		Vacuum HG		Weight		
		in.	mm	in.	mm	in.	mm	in.	mm	lb./ft.	kg/m	
20524360	1½	38.00	1.92	48.70	150	1.03	2.25	57.20	29	737	0.73	1.09
20524361	2	51.20	2.44	61.90	150	1.03	3.00	76.00	29	737	0.95	1.42
20524362	3	76.10	3.54	89.80	150	1.03	4.50	114.00	29	737	1.76	2.62
20524363	4	102.10	4.57	116.10	150	1.03	6.00	152.00	29	737	2.41	3.59



Blue Flexwing®



Product Specifications

Application

Handles the majority of today's industrial chemicals in pressure, gravity flow or suction service.

Construction Tube

Clear Specclar® synthetic rubber Cross-Linked Polyethylene (XLPE)

Cover

Blue EPDM synthetic rubber with spiral white stripe (wrapped impression)

Reinforcement

Spiral-plied synthetic fabric with double wire helix

Temperature Range

-25°F to 150°F (-32°C to 66°C)

Packaging

100' exact length, coiled, polywrapped

Branding (Spiral)

Continental ContiTech Blue Flexwing® Chemical Transfer Hose with Specclar® 200 psi WP

Couplings

Use Continental ContiTech Insta-Lock™ Cam & Groove Fittings with the product. For available Insta-Lock products, contact Customer Service.

Non-Stock/Sizes

400' minimum if not stocked.

Order Codes

546-066 (1/2"-4")
51-066 (6")

Blue Flexwing®

SAP #	ID		Nom. OD		Max. WP		Bend Radius		Vacuum HG		Weight	
	in.	mm	in.	mm	psi	MPa	in.	mm	in.	mm	lb./ft.	kg/m
Blue	1/2	12.7	0.96	24.4	200	1.38	6	152	29	737	0.3	0.45
	3/4	19.1	1.22	31	200	1.38	7	178	29	737	0.45	0.67
	1	25.4	1.47	37.3	200	1.38	8	203	29	737	0.55	0.82
	1 1/4	31.8	1.75	44.5	200	1.38	9	229	29	737	0.7	1.04
	1 1/2	38.1	2.04	51.8	200	1.38	10	254	29	737	0.95	1.41
	2	50.8	2.58	65.5	200	1.38	12	305	29	737	1.22	1.82
	2 1/2	63.5	3.13	79.5	200	1.38	15	381	29	737	1.65	2.46
	3	76.2	3.7	94	200	1.38	18	457	29	737	2.24	3.33
	4	101.6	4.73	120.1	200	1.38	24	610	29	737	3.01	4.48
	6	152.4	6.89	175	200	1.38	36	914	29	737	6.14	9.1

Air & Multipurpose
General Purpose
Heavy Duty
Push-on

Chemical Transfer

Cleaning Equipment

Food
Transfer
Washdown

Marine

Material Handling
Abrasives
Bulk Transfer
Cement & Concrete

Mining

Petroleum
Aircraft Fueling
Dispensing
Dock
Transfer

Spray

Steam

Vacuum

LPG Delivery

Water
Discharge
Suction & Discharge
Washdown

Welding

Coupling Systems

Equipment

Appendix

Cleaning Equipment



Air & Multipurpose

- General Purpose
- Heavy Duty
- Push-on

Chemical Transfer

Cleaning Equipment

Food

- Transfer
- Washdown

Marine

Material Handling

- Abrasives
- Bulk Transfer
- Cement & Concrete

Mining

Petroleum

- Aircraft Fueling
- Dispensing
- Dock Transfer

Spray

Steam

Vacuum

LPG Delivery

Water

- Discharge
- Suction & Discharge
- Washdown

Welding

Coupling Systems

Equipment

Appendix

	Page	Superior Abrasion Cover	Oil Resistance Cover	Microban Cover	Temp. Range	Non-Marking*	Wire	Textile	Couple Assemblies
Fortress 300	89	Yes	Yes	Yes	-20°F to 200°F (-29°C to 93°C)	Yes		Yes	
Fortress 1000	90	Yes	Yes	Yes	-20°F to 200°F (-29°C to 93°C)	Yes		Yes	Yes
Fortress 3000	91	Yes	Yes	Yes	-20°F to 250°F (-29°C to 121°C)	Yes	Yes		Yes
Galvanator 3000	67	Yes	Yes		-20°F to 250°F (-29°C to 121°C)	Yes	Yes		Yes
Gauntlet 1500	62	Yes	Yes		-20°F to 200°F (-29°C to 93°C)	Yes		Yes	Yes
Gauntlet 3000	65	Yes	Yes		-20°F to 250°F (-29°C to 121°C)	Yes	Yes		Yes
Gauntlet 4500	64	Yes	Yes		-20°F to 250°F (-29°C to 121°C)	Yes	Yes		Yes
Neptune 1500	57				-20°F to 200°F (-29°C to 93°C)	Yes		Yes	Yes
Neptune 3000	59				-20°F to 250°F (-29°C to 121°C)	Yes	Yes		Yes
Neptune 4001-R	58				-20°F to 250°F (-29°C to 121°C)	Yes	Yes		Yes
Neptune 4500	61				-20°F to 250°F (-29°C to 121°C)	Yes	Yes		Yes
Neptune 6000	60				-20°F to 250°F (-29°C to 121°C)	Yes	Yes		Yes
SpiraFlow	56				-20°F to 250°F (-29°C to 121°C)	Yes	Yes		Yes
Whitewater	63				-20°F to 250°F** (-29°C to 121°C)	Yes	Yes		Yes

*Non-black colors

**Hot water for Steam Cleaner Service at 325°F (163°C) and 350 psi

SpiraFlow®



Product Specifications

Application

Designed specifically for the pressure washer industry. A pressure washer hose that reduces damming which can cause clean spots. Ideal for surface cleaning applications such as parking decks and lots; beef, dairy and poultry operations; gas stations; garages; and auto mechanic shops.

Construction Tube

Black Nitrile synthetic rubber

Cover

Black, Blue or Gray oil-resistant synthetic rubber, RMA Class B (Medium/High Oil Resistance)

Reinforcement

Braided (1) steel wire

Temperature Range

-20°F to 250°F (-29°C to 121°C)

Packaging

500' reels, maximum 3 pieces, 50' increments, coupled lengths available.

Branding

Not branded

Couplings

Contact fitting manufacturer for proper fitting recommendations and coupling procedure.

Order Codes

539-185 (black)
539-186 (blue)
539-187 (gray)

SpiraFlow®

SAP #			ID		Nom. OD		Max. WP		Weight	
Black	Blue	Gray	in.	mm	in.	mm	psi	MPa	lb./ft.	kg/m
20342127	20342128	20342221	3/8	9.53	0.78	19.69	4000	27.58	0.30	0.44

Air & Multipurpose

General Purpose
Heavy Duty
Push-on

Chemical Transfer

Cleaning Equipment

Food
Transfer
Washdown

Marine

Material Handling

Abrasives
Bulk Transfer
Cement & Concrete

Mining

Petroleum

Aircraft Fueling
Dispensing
Dock
Transfer

Spray

Steam

Vacuum

LPG Delivery

Water

Discharge
Suction & Discharge
Washdown

Welding

Coupling Systems

Equipment

Appendix

Neptune™ 1500



Air & Multipurpose

- General Purpose
- Heavy Duty
- Push-on

Chemical Transfer

Cleaning Equipment

- Food
- Transfer
- Washdown

Marine

Material Handling

- Abrasives
- Bulk Transfer
- Cement & Concrete

Mining

Petroleum

- Aircraft Fueling
- Dispensing
- Dock
- Transfer

Spray

Steam

Vacuum

LPG Delivery

Water

- Discharge
- Suction & Discharge
- Washdown

Welding

Coupling Systems

Equipment

Appendix

Product Specifications

Application

For pressure washer equipment, agricultural sprayers and high-pressure air lines.

Construction Tube

Nitrile synthetic rubber

Cover

Blue, Gray, Red, Yellow or Black oil-resistant synthetic rubber, RMA Class B (Medium Oil Resistance)

Reinforcement

Braided (1) synthetic yarn up through 1/2". Braided (2) synthetic yarn for 3/4"

Temperature Range

-20°F to 200°F (-29°C to 93°C)

Packaging

1/4"-5/16" - 550' to 750' reels, max 8 pieces, 25' minimum
 3/8"-500' reels, max 3 pieces, 50' increments
 1/2"-3/4" - 450' to 550' reels, max 5 pieces, 10' minimum

Branding

Example: Continental ContiTech Neptune™ 1500 3/8" 1500 psi WP. Made in U.S.A.

Couplings

Contact fitting manufacturer for proper fitting recommendation and coupling procedure. Coupled lengths with MxMS fittings and Kink Guards available.

Order Codes

- 536-374 (blue)
- 536-387 (gray)
- 536-388 (black)
- 536-490 (yellow)

Neptune™ 1500

SAP #	ID			Nom. OD		Max. WP		Weight			
	Blue	Gray	Black	Yellow	in.	mm	psi	MPa	lb./ft.	kg/m	
20449806	20023093	20023102		1/4	6.4	0.59	15.0	1500	10.34	0.11	0.16
		20023106		5/16	7.9	0.69	17.5	1500	10.34	0.15	0.22
20142362	20023096	20023109	20029580	3/8	9.5	0.75	19.1	1500	10.34	0.18	0.27
20590578	20023099	20023116		1/2	12.7	0.84	21.3	1200	8.27	0.19	0.28

Note: Not recommended for steam service.

Neptune™ 1500 in 1/2" ID size is rated at a working pressure rating of 1200 psi. All other sizes listed above are rated at a working pressure of 1500 psi.

Neptune™ 4001-R



Product Specifications

Application

For high-pressure washer equipment with working pressures up to 4000 psi.

Construction Tube

Nitrile synthetic rubber

Cover

Black, Yellow, Blue or Gray oil resistant synthetic rubber, RMA Class B (Medium Oil Resistance)

Reinforcement

Braided (1) steel wire

Temperature Range

-20°F to 250°F (-29°C to 121°C)

Packaging

500' reel, maximum 3 pieces, 50' increments

Branding

Example: Continental ContiTech Neptune™ 4001-R 3/8" 4000 psi WP. Made in U.S.A.

Couplings

Use Continental ContiTech pressure washing fittings with this product. See the Coupling Systems information pages at the back of the catalog for available sizes. Refer to the Continental ContiTech Hose Assembly Manual for crimp procedures. Coupled lengths with MxMS fittings and Kink Guards available.

Order Codes

539-261 (black)
 539-266 (yellow)
 539-265 (blue)
 539-262 (gray)
 539-111 (red)

Neptune™ 4001-R

SAP #				ID		Nom. OD		Max. WP		Weight	
Black	Yellow	Blue	Gray	in.	mm	in.	mm	psi	MPa	lb./ft.	kg/m
20129270	20135601	20119564	20527217	3/8	9.5	0.69	17.5	4000	27.58	0.25	0.37

Note: Not recommended for steam service.

Air & Multipurpose

General Purpose
 Heavy Duty
 Push-on

Chemical Transfer

Cleaning Equipment

Food
 Transfer
 Washdown

Marine

Material Handling

Abrasives
 Bulk Transfer
 Cement & Concrete

Mining

Petroleum

Aircraft Fueling
 Dispensing
 Dock
 Transfer

Spray

Steam

Vacuum

LPG Delivery

Water

Discharge
 Suction & Discharge
 Washdown

Welding

Coupling Systems

Equipment

Appendix

Neptune™ 3000



Air & Multipurpose
 General Purpose
 Heavy Duty
 Push-on

Chemical Transfer

Cleaning Equipment

Food
 Transfer
 Washdown

Marine

Material Handling
 Abrasives
 Bulk Transfer
 Cement & Concrete

Mining

Petroleum
 Aircraft Fueling
 Dispensing
 Dock
 Transfer

Spray

Steam

Vacuum

LPG Delivery

Water
 Discharge
 Suction & Discharge
 Washdown

Welding

Coupling Systems

Equipment

Appendix

Product Specifications

Application

For use on pressure washer machines with working pressures up to 3000 psi.

Construction Tube

Nitrile synthetic rubber

Cover

Black, Blue, Yellow or Gray oil-resistant synthetic rubber, RMA Class B (Medium Oil Resistance)

Reinforcement

Braided (1) steel wire

Temperature Range

-20°F to 250°F (-29°C to 121°C)

Packaging

500' reel, maximum 3 pieces, 50' increments

Branding

Example: Continental ContiTech Neptune™ 3000 3/8" 3000 psi WP. Made in U.S.A.

Couplings

Use Continental ContiTech pressure washing fittings with this product. See the Coupling Systems information pages at the back of the catalog for available sizes. Refer to the Continental ContiTech Hose Assembly Manual for crimp procedures. Coupled lengths with MxMS fittings and Kink Guards available.

Order Codes

539-085 (black)
 539-089 (blue)
 539-104 (yellow)
 539-090 (gray)

Neptune™ 3000

SAP #	ID				Nom. OD		Max. WP		Weight		
	Black	Blue	Yellow	Gray	in.	mm	psi	MPa	lb./ft.	kg/m	
20023506	20023623	20155405	20023720	1/4	6.4	0.53	13.5	3000	20.69	0.15	0.22
20023518	20023638	20023949	20023726	3/8	9.5	0.69	17.5	3000	20.69	0.24	0.36
20023613	20023670	20023959	20216243	1/2	12.7	0.82	20.8	3000	20.69	0.32	0.48

Note: Not recommended for steam service.

Neptune™ 6000



Product Specifications

Application

For use on pressure washer machines with working pressures up to 6000 psi.

Construction Tube

Nitrile synthetic rubber

Cover

Black oil resistant synthetic rubber, RMA Class B (Medium Oil Resistance)

Reinforcement

Braided (2) steel wires

Temperature Range

-20°F to 250°F (-29°C to 121°C)

Packaging

500' reels, maximum 3 piece, 50' increments, coupled lengths available

Branding

Example: Continental ContiTech Neptune™ 6000 3/8" 6000 psi WP. Made in U.S.A.

Couplings

Contact fitting manufacturer for proper fitting recommendation and coupling procedure.

Order Codes

539-149 (black)
539-148 (gray)

Neptune™ 6000

SAP #		ID		Nom. OD		Max. WP		Weight	
Black	Gray	in.	mm	in.	mm	psi	MPa	lb./ft.	kg/m
20046112	20551519	3/8	9.5	0.69	17.5	6000	41.37	0.30	0.45

Note: Not recommended for steam service.

Air & Multipurpose

General Purpose
Heavy Duty
Push-on

Chemical Transfer

Cleaning Equipment

Food
Transfer
Washdown

Marine

Material Handling
Abrasives
Bulk Transfer
Cement & Concrete

Mining

Petroleum
Aircraft Fueling
Dispensing
Dock
Transfer

Spray

Steam

Vacuum

LPG Delivery

Water
Discharge
Suction & Discharge
Washdown

Welding

Coupling Systems

Equipment

Appendix

Neptune™ 4500



Air & Multipurpose
 General Purpose
 Heavy Duty
 Push-on

Chemical Transfer

Cleaning Equipment

Food
 Transfer
 Washdown

Marine

Material Handling
 Abrasives
 Bulk Transfer
 Cement & Concrete

Mining

Petroleum
 Aircraft Fueling
 Dispensing
 Dock
 Transfer

Spray

Steam

Vacuum

LPG Delivery

Water
 Discharge
 Suction & Discharge
 Washdown

Welding

Coupling Systems

Equipment

Appendix

Product Specifications

Application

For use on pressure washer machines with working pressures up to 4500 psi.

Construction Tube

Nitrile synthetic rubber

Cover

Black or Blue oil-resistant synthetic rubber, RMA Class B (Medium Oil Resistance)

Reinforcement

Braided (2) steel wires

Temperature Range

-20°F to 250°F (-29°C to 121°C)

Packaging

1/4"-3/8" - 500' reels, maximum 3 pieces, minimum of 50' lengths
 1/2" - 500' reels, maximum 3 pieces, minimum of 50' lengths

Branding

Example: Continental ContiTech Neptune™ 4500 3/8" 4500 psi WP. Made in U.S.A.

Couplings

Use Continental ContiTech pressure washing fittings with this product. See the Coupling Systems information pages at the back of the catalog for available sizes. Refer to the Continental ContiTech Hose Assembly Manual for crimp procedures. Coupled lengths with MxMS fittings and Kink Guards available.

Order Codes

539-091 (black)
 539-124 (blue)

Neptune™ 4500

SAP #	ID		Nom. OD		Max. WP		Weight			
	Black	Blue	in.	mm	psi	MPa	lb./ft.	kg/m		
		20069357	1/4	6.4	0.54	13.7	4500	31.03	0.20	0.30
20023741	20024005		3/8	9.5	0.69	17.5	4500	31.03	0.28	0.42
20023757			1/2	12.7	0.82	20.8	4500	31.03	0.35	0.52

Note: Not recommended for steam service.

Gauntlet® 1500



Product Specifications

Application

Gauntlet® 1500 is for pressure washer equipment with working pressures up to 1500 psi. Its super abrasion-resistant cover provides maximum protection against adverse effects of oil and animal fats.

Construction Tube

Nitrile synthetic rubber

Cover

Black or Yellow oil-resistant Carbryn™ synthetic rubber, RMA Class A (High Oil Resistance)

Reinforcement

Braided (1) synthetic yarn up through 1/2". Braided (2) synthetic yarn for 3/4"

Temperature Range

-20°F to 200°F (-29°C to 93°C)

Packaging

500' reel, maximum 3 pieces, 50' increments

Branding

Example: Continental ContiTech Gauntlet® 1500 3/8" 1500 psi. Made in U.S.A.

Couplings

Contact fitting manufacturer for proper fitting recommendation and coupling procedure. Coupled lengths with MxMS fittings and Kink Guards available.

Order Codes

536-480 (black)
536-474 (yellow)
536-574 (red)

Gauntlet® 1500

SAP #			ID		Nom. OD		Max. WP		Weight	
Black	Yellow	Red	in.	mm	in.	mm	psi	MPa	lb./ft.	kg/m
20023338	20045137		1/4	6.4	0.59	15.0	1500	10.34	0.11	0.16
20023339	20023331		3/8	9.5	0.75	19.1	1500	10.34	0.18	0.27
20023341	20023333	20115073	1/2	12.7	0.84	21.3	1200	8.27	0.18	0.27

Note: Not recommended for steam service.

Gauntlet® 1500 in the 1/2" ID is rated at a working pressure of 1200 psi. All other sizes listed above are rated at a working pressure of 1500 psi.

Air & Multipurpose
General Purpose
Heavy Duty
Push-on

Chemical Transfer

Cleaning Equipment

Food
Transfer
Washdown

Marine

Material Handling
Abrasives
Bulk Transfer
Cement & Concrete

Mining

Petroleum
Aircraft Fueling
Dispensing
Dock
Transfer

Spray

Steam

Vacuum

LPG Delivery

Water
Discharge
Suction & Discharge
Washdown

Welding

Coupling Systems

Equipment

Appendix

Whitewater®



Air & Multipurpose

- General Purpose
- Heavy Duty
- Push-on

Chemical Transfer

Cleaning Equipment

- Food Transfer Washdown

Marine

Material Handling

- Abrasives
- Bulk Transfer
- Cement & Concrete

Mining

Petroleum

- Aircraft Fueling
- Dispensing
- Dock Transfer

Spray

Steam

Vacuum

LPG Delivery

Water

- Discharge
- Suction & Discharge
- Washdown

Welding

Coupling Systems

Equipment

Appendix

Product Specifications

Application

For use on either steam cleaner machines or combination steam cleaner/pressure washer machines.

Construction Tube

Pyrosyn® synthetic rubber

Cover

Black and Red Hysunite™ synthetic rubber, RMA Class B (Medium Oil Resistance)

Reinforcement

Braided (1) steel wire

Temperature Range

Handles hot water at 325°F (163°C) and 350 psi for Steam Cleaning Service, handles hot water at 250°F (121°C) and 3000 psi (2500 psi on 1/2") for Pressure Washer Service

Packaging

500' reel, maximum 3 pieces, 50' increments coupled lengths available

Branding

Example: Continental ContiTech 3/8" Whitewater® Pressure Washer 3000 psi/250°F (121°C) Steam Cleaner 350 psi/325°F (163°C). Made in U.S.A.

Couplings

Contact fitting manufacturer for proper fitting recommendation and coupling procedure.

Order Codes

- 539-095 (black)
- 539-110 (red)

Whitewater® - Steam Cleaner Service - up to 325°F (163°C)

SAP #		Nom. ID		Nom. OD		Max. WP		Weight	
Black	Red	in.	mm	in.	mm	psi	MPa	lb./ft.	kg/m
20023806	20023984	3/8	9.50	0.69	17.50	350	2.40	0.23	0.34
20023820	20023987	1/2	12.70	0.83	21.20	350	2.40	0.31	0.46

Whitewater® - Pressure Washer Service - up to 250°F (121°C)

SAP #		Nom. ID		Nom. OD		Max. WP		Weight	
Black	Red	in.	mm	in.	mm	psi	MPa	lb./ft.	kg/m
20023806	20023984	3/8	9.50	0.69	17.50	3,000	20.6	0.23	0.34
20023820	20023987	1/2	12.70	0.83	21.20	2,500	16.9	0.31	0.46

Note: Not recommended for steam service.

Gauntlet® 4500



Product Specifications

Application

For use on pressure washer machines with working pressures up to 4500 psi. Its super abrasion-resistant cover provides maximum protection against adverse effects of oil and animal fats.

Construction Tube

Nitrile synthetic rubber

Cover

Black or Yellow oil-resistant Carbryn™ synthetic rubber, RMA Class A (High Oil Resistance)

Reinforcement

Braided (2) steel wires

Temperature Range

-20°F to 250°F (-29°C to 121°C)

Packaging

1/4"-3/8" - 500' reels, maximum 3 pieces, minimum of 50' lengths, coupled lengths available

1/2" - 500' reels, maximum 3 pieces, minimum of 50' lengths, coupled lengths available

Branding

Example: Continental ContiTech Gauntlet® 4500 3/8" 4500 psi WP. Made in U.S.A.

Couplings

Use Continental ContiTech pressure washing fittings with this product. See the Coupling Systems information pages at the back of the catalog for available sizes. Refer to the Continental ContiTech Hose Assembly Manual for crimp procedures. Coupled lengths with MxMS fittings and Kink Guards available.

Order Codes

539-122 (black)

539-120 (yellow)

Gauntlet® 4500

SAP #	ID		Nom. OD		Max. WP		Weight			
	Black	Yellow	in.	mm	in.	mm	psi	MPa	lb./ft.	kg/m
20331250			1/4	6.4	0.54	13.7	4500	31.03	0.20	0.30
20220625	20024000		3/8	9.5	0.69	17.5	4500	31.03	0.27	0.40
20048788	20325124		1/2	12.7	0.82	20.8	4500	31.03	0.34	0.51

Note: Not recommended for steam service.

Air & Multipurpose
General Purpose
Heavy Duty
Push-on

Chemical Transfer

Cleaning Equipment

Food
Transfer
Washdown

Marine

Material Handling
Abrasives
Bulk Transfer
Cement & Concrete

Mining

Petroleum
Aircraft Fueling
Dispensing
Dock
Transfer

Spray

Steam

Vacuum

LPG Delivery

Water
Discharge
Suction & Discharge
Washdown

Welding

Coupling Systems

Equipment

Appendix

Gauntlet® 3000



Air & Multipurpose

- General Purpose
- Heavy Duty
- Push-on

Chemical Transfer

Cleaning Equipment

- Food
- Transfer
- Washdown

Marine

Material Handling

- Abrasives
- Bulk Transfer
- Cement & Concrete

Mining

Petroleum

- Aircraft Fueling
- Dispensing
- Dock
- Transfer

Spray

Steam

Vacuum

LPG Delivery

Water

- Discharge
- Suction & Discharge
- Washdown

Welding

Coupling Systems

Equipment

Appendix



Product Specifications

Application

For use on pressure washer machines with working pressures up to 3000 psi. Its super abrasion-resistant cover provides maximum protection against adverse effects of oil and animal fats.

Construction Tube

Nitrile synthetic rubber

Cover

Black or Yellow oil-resistant Carbryn™ synthetic rubber, RMA Class A (High Oil Resistance)

Reinforcement

Braided (1) steel wire

Temperature Range

-20°F to 250°F (-29°C to 121°C)

Packaging

500' reels, maximum 3 pieces, 50' increments

Branding

Example: Continental ContiTech Gauntlet® 3000 3/8" 3000 psi. Made in U.S.A.

Couplings

Use Continental ContiTech pressure washing fittings with this product. See the Coupling Systems information pages at the back of the catalog for available sizes. Refer to the Continental ContiTech Hose Assembly Manual for crimp procedures. Coupled lengths with MxMS fittings and Kink Guards available.

Order Codes

- 539-099 (black)
- 539-100 (yellow)

Gauntlet® 3000

SAP #	ID		Nom. OD		Max. WP		Weight		
	Black	Yellow	in.	mm	in.	mm	psi	MPa	lb./ft.
20023887	20023890	3/8	9.5	0.69	17.5	3000	20.69	0.24	0.36
20023889	20023894	1/2	12.7	0.82	20.8	3000	20.69	0.32	0.48

Note: Not recommended for steam service.

Hydrocarbon Drain Hose®



Product Specifications

Application

Heavy Duty hose designed for use in hydrocarbon drain service.

Construction Tube

Black Nitrile

Cover

Blue Wingprene

Reinforcement

Spiral Piled two steel wires

Temperature Range

-25°F to 350°F (-32°C to 177°C)

Packaging

100' Lengths, coiled and polywrapped

Branding

Continental ContiTech Hydrocarbon Drain Hose 300 PSI

Hydrocarbon Drain Hose®

SAP#	ID		OD		Max. WP	Weight
	in.	mm	in.	mm	psi	lb./ft.
20264356	3/4	19.1	1.33	33.86	300	0.63
20467694	1	25.4	1.58	40.14	300	0.78
20326679	1 1/2	38.1	2.25	57.2	300	1.57
20276441	2	50.8	2.77	70.36	300	2.01

Couplings

Contact fitting manufacturer for proper fitting recommendation and coupling procedure

Order Code

543-729

Air & Multipurpose

General Purpose
Heavy Duty
Push-on

Chemical Transfer

Cleaning Equipment

Food

Transfer
Washdown

Marine

Material Handling

Abrasives
Bulk Transfer
Cement & Concrete

Mining

Petroleum

Aircraft Fueling
Dispensing
Dock
Transfer

Spray

Steam

Vacuum

LPG Delivery

Water

Discharge
Suction & Discharge
Washdown

Welding

Coupling Systems

Equipment

Appendix

Galvanator® 3000



Air & Multipurpose
 General Purpose
 Heavy Duty
 Push-on

Chemical Transfer

Cleaning Equipment

Food
 Transfer
 Washdown

Marine

Material Handling
 Abrasives
 Bulk Transfer
 Cement & Concrete

Mining

Petroleum
 Aircraft Fueling
 Dispensing
 Dock
 Transfer

Spray

Steam

Vacuum

LPG Delivery

Water
 Discharge
 Suction & Discharge
 Washdown

Welding

Coupling Systems

Equipment

Appendix



Product Specifications

Application

For pressure washer equipment. Its rust-resistant reinforcement and superior abrasion-resistant cover provide maximum protection against adverse effects of water, oil and animal fats.

Construction Tube

Nitrile synthetic rubber

Cover

Yellow or Black Carbryn™ synthetic rubber (wrapped finish), ORS, RMA Class A (High Oil Resistance)

Reinforcement

Braided (2) steel wires

Temperature Range

-20°F to 250°F (-29°C to 121°C)

Packaging

500' reels, maximum 3 pieces, 50' increments

Branding

Example: Galvanator® 3000 3/8" (9.5mm) 3000 psi (20.7 MPa). Made in U.S.A.

Couplings

Contact fitting manufacturer for proper fitting recommendation and coupling procedure. Coupled lengths with MxMS fittings and Kink Guards available.

Order Codes

539-200 (yellow)
 539-201 (black)

Galvanator® 3000

SAP #		ID		Nom. OD		Max. WP		Bend Radius		Weight	
Yellow	Black	in.	mm	in.	mm	psi	MPa	in.	mm	lb./ft.	kg/m
20024095	20024109	3/8	9.5	6.9	17.5	3000	20.69	5.0	127	0.26	0.39
20024100	20024110	1/2	12.7	0.82	20.8	3000	20.69	7.0	178	0.31	0.49

Note: Not recommended for steam service.

Food Transfer



	Page	Dry or Liquid	Temp. Range	Beer/ Wine	Dairy	Clear	Thermo-plastic	3-A, FDA, Rubber USDA	Static NSF 61 Wire	Helical Wire
Exstatic	72	Dry	-25°F to 180°F (-32°C to 82°C)	Yes	Yes			Yes	Yes	Yes
EZ Glide Wine	84	Liquid	-20°F to 180°F (-29°C to 82°C)	Yes				Yes	Yes	Yes
Gray Flextra LT	71	Liquid	-25°F to 212°F (-32°C to 100°C)	Yes	Yes			Yes	Yes	Yes
Harvest	73	Dry	-25°F to 180°F (-32°C to 82°C)					Yes	Yes	Yes
Nutriflex S&D	75	Both	-15°F to 158°F (-26°C to 70°C)	Yes	Yes	Yes	Yes		Yes	Yes
Nutrilex Static Wire	76	Dry	-15°F to 158°F (-26°C to 70°C)		Yes	Yes	Yes		Yes	Yes
Nutriflo S&D	74	Both	-15°F to 158°F (-26°C to 70°C)	Yes	Yes	Yes	Yes		Yes	Yes
Plicord Blue Flour	77	Dry	-40°F to 180°F (-40°C to 82°C)					Yes	FDA	Yes
Plicord Brewline	78	Liquid	-40°F to 220°F (-40°C to 104°C)	Yes				Yes	Yes	
Plicord ExtremeFlex Beverage Gray	85	Liquid	-30°F to 220°F (-34°C to 104°C)	Yes	Yes			Yes	Yes	Yes
Plicord ExtremeFlex Beverage Red with EZ Clean Cover	86	Liquid	-30°F to 220°F (-34°C to 104°C)	Yes	Yes			Yes	Yes	Yes
Plicord ExtremeFlex Food Grade	79	Dry	-25°F to 212°F (-32°C to 100°C)		Yes			Yes	Yes	Yes
Plicord Gray Food	70	Liquid	-25°F to 230°F (-32°C to 110°C)		Yes			Yes	Yes	Yes
Plicord Winline	80	Liquid	-40°F to 220°F (-40°C to 104°C)	Yes				Yes	Yes	
Pliovic FG (FDA-3A)	81	Both	-10°F to 158°F (-23°C to 70°C)	Yes	Yes	Yes	Yes		Yes	Yes
Potable Water	82	Liquid	-40°F to 180°F (-40°C to 82°C)					Yes	Yes	
Spirathane PT	129	Dry	0°F to 158°F (-18°C to 70°C)			Yes	Yes		FDA	Yes
Tan Flextra	88	Dry	-40°F to 180°F (-40°C to 82°C)							Yes
Tan Flexwing	87	Liquid	-40°F to 180°F (-40°C to 82°C)					Yes	Yes	Yes
Tan Softwall	89									
Velocity Beverage Transfer	90									
Vintner	83	Liquid	-30°F to 220°F (-34°C to 104°C)	Yes				Yes	Yes	
White Flexwing	69	Both	-25°F to 230°F (-32°C to 110°C)		Yes			Yes	Yes	Yes

Air & Multipurpose
 General Purpose
 Heavy Duty
 Push-on

Chemical Transfer

Cleaning Equipment

Food Transfer Washdown

Marine

Material Handling
 Abrasives
 Bulk Transfer
 Cement & Concrete

Mining

Petroleum
 Aircraft Fueling
 Dispensing
 Dock
 Transfer

Spray

Steam

Vacuum

LPG Delivery

Water
 Discharge
 Suction & Discharge
 Washdown

Welding

Coupling Systems

Equipment

Appendix

White Flexwing®



Air & Multipurpose
 General Purpose
 Heavy Duty
 Push-on

Chemical Transfer

Cleaning Equipment

Food
 Transfer
 Washdown

Marine

Material Handling
 Abrasives
 Bulk Transfer
 Cement & Concrete

Mining

Petroleum
 Aircraft Fueling
 Dispensing
 Dock
 Transfer

Spray

Steam

Vacuum

LPG Delivery

Water
 Discharge
 Suction & Discharge
 Washdown

Welding

Coupling Systems

Equipment

Appendix

Product Specifications

Application

A highly flexible hose for gravity flow, pressure, or suction service transferring oily and non-oily edibles from tank truck and in-plant service.

Construction Tube

White Chemivic™ synthetic rubber (FDA/USDA compliant and conforms to 3-A Sanitary Standard 18-03)

Cover

White Chemivic™ synthetic rubber (wrapped impression)

Reinforcement

Spiral-plied synthetic fabric with galvanized wire helix

Temperature Range

-25°F to 230°F (-32°C to 110°C)

Packaging

100' length, coiled, polywrapped

Branding (Spiral)

Example: Continental ContiTech White Flexwing® 150 psi WP; FDA, 3-A, and USDA

Couplings

Contact fitting manufacturer for proper fitting recommendations and coupling procedure.

Order Codes

549-151

White Flexwing®

SAP #	ID		Nom. OD		Max. WP		Bend Radius		Vacuum HG		Weight		
	White	in.	mm	in.	mm	psi	MPa	in.	mm	in.	mm	lb./ft.	kg/m
20019284	3/4		19.1	1.20	30.5	150	1.03	2	51	29	737	0.47	0.70
20019286	1		25.4	1.44	36.6	150	1.03	3	76	29	737	0.57	0.85
20019287	1¼		31.8	1.70	43.2	150	1.03	4	102	29	737	0.69	1.03
20019289	1½		38.1	1.97	50.0	150	1.03	4	102	29	737	0.86	1.28
20019292	2		50.8	2.53	64.3	150	1.03	5	114	29	737	1.23	1.83
20019296	2½		63.5	3.10	78.7	150	1.03	6	146	29	737	1.81	2.69
20019297	3		76.2	3.60	91.4	150	1.03	7	178	29	737	2.16	3.21
20019301	4		101.6	4.64	117.9	150	1.03	10	254	29	737	3.05	4.54

For Continental ContiTech food hose compliance information, see Appendix C.

Plicord® Gray Food



Product Specifications

Application

A flexible hose for gravity flow, pressure, or suction service transferring edibles from tank truck and in-plant service.

Construction Tube

White Chemivic™ synthetic rubber (FDA/USDA compliant and conforms to 3-A Sanitary Standard 18-03)

Cover

Gray Chemivic™ synthetic rubber (wrapped impression)

Reinforcement

Spiral-plied synthetic fabric with galvanized wire helix

Temperature Range

-25°F to 230°F (-32°C to 110°C)

Packaging

100' length, coiled, polywrapped

Branding (Spiral)

Example: Continental ContiTech Plicord® Gray Food; FDA, 3-A, and USDA 150 psi

Couplings

Contact fitting manufacturer for proper fitting recommendations and coupling procedure.

Order Codes

549-834

Plicord® Gray Food

SAP #	ID	Nom. OD		Max. WP		Bend Radius		Vacuum HG		Weight		
		in.	mm	in.	mm	in.	mm	in.	mm	lb./ft.	kg/m	
20020211	1	25.4	1.45	36.7	150	1.03	3	75	29	737	0.58	0.86
20020212	1½	38.1	1.97	50.0	150	1.03	4	102	29	737	0.85	1.26
20020214	2	50.8	2.59	65.8	150	1.03	5	114	29	737	1.42	2.11
20020216	2½	63.5	3.09	78.5	150	1.03	6	152	29	737	1.77	2.63
20020217	3	76.2	3.59	91.2	150	1.03	7	178	29	737	2.10	3.13
20020219	4	101.6	4.68	118.9	150	1.03	10	254	29	737	3.19	4.75

For Continental ContiTech food hose compliance information, see Appendix C.

Air & Multipurpose
General Purpose
Heavy Duty
Push-on

Chemical Transfer

Cleaning Equipment

Food
Transfer
Washdown

Marine

Material Handling
Abrasives
Bulk Transfer
Cement & Concrete

Mining

Petroleum
Aircraft Fueling
Dispensing
Dock
Transfer

Spray

Steam

Vacuum

LPG Delivery

Water
Discharge
Suction & Discharge
Washdown

Welding

Coupling Systems

Equipment

Appendix

Gray Flextra® LT



Air & Multipurpose
 General Purpose
 Heavy Duty
 Push-on

Chemical Transfer

Cleaning Equipment

Food
 Transfer
 Washdown

Marine

Material Handling
 Abrasives
 Bulk Transfer
 Cement & Concrete

Mining

Petroleum
 Aircraft Fueling
 Dispensing
 Dock
 Transfer

Spray

Steam

Vacuum

LPG Delivery

Water
 Discharge
 Suction & Discharge
 Washdown

Welding

Coupling Systems

Equipment

Appendix



Product Specifications

Application

A lightweight, highly flexible hose used for transferring edibles in gravity flow, pressure or suction service. Larger ID sizes (5" and 6") applicable as "must" hoses in the wine industry.

Construction Tube

White Chemivic™ (complies with FDA, USDA and 3-A)

Cover

Gray Chemivic™ (corrugated, wrapped impression)

Reinforcement

Synthetic textile fabric plies and two galvanized wire helix

Temperature Range

-25°F to 212°F (-32°C to 100°C)

Packaging

Coiled-polyethylene wrapped/bagel pack

Branding (Spiral)

Example: Continental ContiTech Gray Flextra® LT 150 psi WP; FDA, 3-A and USDA

Couplings

Contact fitting manufacturer for proper fitting recommendation and coupling procedure.

Order Codes

549-357

Gray Flextra® LT

SAP #	ID		Nom. OD		Max. WP		Bend Radius		Vacuum HG		Weight	
	in.	mm	in.	mm	psi	MPa	in.	mm	in.	mm	lb./ft.	kg/m
20155751	1½	38.1	1.92	48.8	150	1.03	3	64	29	737	0.77	1.15
20134015	2	50.8	2.44	62.0	150	1.03	3	76	29	737	1.00	1.49
20313545	2½	63.5	3.00	76.2	150	1.03	5	127	29	737	1.46	2.17
20070367	3	76.2	3.51	89.2	150	1.03	6	140	29	737	1.95	2.90
20131039	4	101.6	4.55	115.6	150	1.03	7	191	29	737	2.59	3.85
20129912	5	127.0	5.66	143.8	150	1.03	12	305	29	737	3.84	5.71
20129913	6	152.4	6.66	169.2	150	1.03	17	432	29	737	4.55	6.77

For Continental ContiTech food hose compliance information, see Appendix C.

Exstatic®



Product Specifications

Application

Exstatic® hose is for tank truck and/or in-plant transfer of dry, bulk foodstuffs where there is a potential for electrical static build-up.

Construction Tube

FDA UHMWPE (static dissipating/static conductive) has FDA/USDA compliant materials

Cover

Blue SBR synthetic rubber (corrugated) / spiral transfer brand (wrapped impression)

Reinforcement

Spiral-plied synthetic fabric with double wire helix

Temperature Range

-25°F to 180°F (-32°C to 82°C)

Packaging

100' length, coiled, polywrapped

Branding (Spiral)

Example: Continental ContiTech Plicord® Exstatic® FDA Dry Material handling 150 psi

Couplings

Contact fitting manufacturer for proper fitting recommendation and coupling procedure. Use Continental ContiTech Insta-Lock™ Cam & Groove Fittings with this product. See the Couplings Systems information pages at the back of the catalog.

Order Codes

549-608

Exstatic®

SAP #	ID		Nom. OD		Max. WP		Bend Radius		Vacuum HG		Weight	
	in.	mm	in.	mm	psi	MPa	in.	mm	in.	mm	lb./ft.	kg/m
20019899	2	50.8	2.50	63.5	150	1.03	8	203	29	737	1.07	1.59
20019901	3	76.2	3.56	90.4	150	1.03	12	305	29	737	1.83	2.72
20019904	4	101.6	4.59	116.6	150	1.03	16	406	29	737	2.49	3.71
20019905	5	127.0	5.67	144.0	150	1.03	20	508	29	737	3.69	5.49

For Continental ContiTech food hose compliance information, see Appendix C.

Air & Multipurpose

General Purpose
Heavy Duty
Push-on

Chemical Transfer

Cleaning Equipment

Food
Transfer
Washdown

Marine

Material Handling

Abrasives
Bulk Transfer
Cement & Concrete

Mining

Petroleum

Aircraft Fueling
Dispensing
Dock
Transfer

Spray

Steam

Vacuum

LPG Delivery

Water
Discharge
Suction & Discharge
Washdown

Welding

Coupling Systems

Equipment

Appendix

Harvest[®]



Air & Multipurpose

- General Purpose
- Heavy Duty
- Push-on

Chemical Transfer

Cleaning Equipment

Food

- Transfer
- Washdown

Marine

Material Handling

- Abrasives
- Bulk Transfer
- Cement & Concrete

Mining

Petroleum

- Aircraft Fueling
- Dispensing
- Dock
- Transfer

Spray

Steam

Vacuum

LPG Delivery

Water

- Discharge
- Suction & Discharge
- Washdown

Welding

Coupling Systems

Equipment

Appendix



Product Specifications

Application

For tank truck and/or in-plant applications for the transfer of dry, non-oily bulk foodstuffs.

Construction Tube

FDA, White Pureten™ (natural rubber) (FDA/USDA compliant and conforms to 3-A Sanitary Standard 18-03)

Cover

Gray EPDM synthetic rubber (corrugated) / orange branding tape (wrapped impression)

Reinforcement

Spiral-plied synthetic fabric with double galvanized wire helix

Temperature Range

-25°F to 180°F (-32°C to 82°C)

Packaging

100' length, coiled, polywrapped

Branding (Spiral)

Example: Continental ContiTech Harvest® 150 psi WP; FDA/USDA

Couplings

Contact fitting manufacturer for proper fitting recommendation and coupling procedure.

Order Codes

549-627

Harvest[®]

SAP #	ID	Nom. OD		Max. WP		Bend Radius		Vacuum HG		Weight		
		in.	mm	in.	mm	in.	mm	in.	mm	lb./ft.	kg/m	
20019927	2	50.8	2.73	69.3	150	1.03	5	127	29	737	1.57	2.34
20019928	3	76.2	3.74	95.0	150	1.03	7	178	29	737	2.32	3.45
20019929	4	101.6	4.78	121.4	150	1.03	10	254	29	737	3.44	5.12
20019930	5	127.0	5.91	150.1	150	1.03	15	381	29	737	4.76	7.08

For Continental ContiTech food hose compliance information, see Appendix C.

Nutriflo® Suction and Discharge Hose



Product Specifications

Application

For handling almost every type of dry bulk food material or liquid in gravity flow and vacuum service. Nutriflo® conforms to USDA Meat and Poultry, 3-A Sanitary, and FDA Standards, and is used for the transmission of raw and pasteurized milk and other high water content dairy items.

Construction Tube

Clear Pliovic® (FDA, 3-A, USDA compliant), NSF-61

Cover

Clear Pliovic®

Reinforcement

White or Clear high-density Pliovic® helix

Temperature Range

-15°F to 158°F (-26°C to 70°C)

Packaging

100' length, coiled, polywrapped

Branding

Not branded

Couplings

Contact fitting manufacturer for proper fitting recommendation and coupling procedure.

Order Codes

586-416 (white)

586-421 (clear)

Nutriflo® Suction and Discharge

SAP #		ID		Nom. OD		Max. WP		Bend Radius		Vacuum HG		Weight	
White	Clear	in.	mm	in.	mm	psi	MPa	in.	mm	in.	mm	lb./ft.	kg/m
20013266	20328013	3/4	19.1	0.99	25.2	120	0.83	3	83	29	737	0.18	0.27
20013269	20013329	1	25.4	1.24	31.5	106	0.73	5	114	29	737	0.26	0.39
20013274	20013330	1¼	31.8	1.55	39.4	99	0.68	5	127	29	737	0.36	0.54
20013279	20013331	1½	38.1	1.78	45.2	89	0.61	6	152	29	737	0.43	0.64
20013283	20013332	2	50.8	2.37	60.2	79	0.54	8	203	29	737	0.67	1.00
20013287	20013333	2½	63.5	2.89	73.4	65	0.45	10	254	29	737	0.89	1.32
20013290	20013334	3	76.2	3.48	88.4	65	0.45	12	305	29	737	1.15	1.71
20013293	20013335	4	101.6	4.50	114.3	55	0.38	16	406	29	737	1.65	2.46
20013297	20013337	6	152.4	6.63	168.4	47	0.32	36	914	29	737	3.39	5.04

For Continental ContiTech food hose compliance information, see Appendix C.

Air & Multipurpose

General Purpose
Heavy Duty
Push-on

Chemical Transfer

Cleaning Equipment

Food
Transfer
Washdown

Marine

Material Handling

Abrasives
Bulk Transfer
Cement & Concrete

Mining

Petroleum

Aircraft Fueling
Dispensing
Dock
Transfer

Spray

Steam

Vacuum

LPG Delivery

Water
Discharge
Suction & Discharge
Washdown

Welding

Coupling Systems

Equipment

Appendix

Nutriflex™ Suction and Discharge Hose



Air & Multipurpose

- General Purpose
- Heavy Duty
- Push-on

Chemical Transfer

Cleaning Equipment

Food

- Transfer
- Washdown

Marine

Material Handling

- Abrasives
- Bulk Transfer
- Cement & Concrete

Mining

Petroleum

- Aircraft Fueling
- Dispensing
- Dock
- Transfer

Spray

Steam

Vacuum

LPG Delivery

- Water**
- Discharge
- Suction & Discharge
- Washdown

Welding

Coupling Systems

Equipment

Appendix

Product Specifications

Application

Nutriflex™ S&D hose is capable of handling almost every type of dry bulk food material or liquid in gravity flow and vacuum service. Nutriflex™ conforms to USDA Meat and Poultry, 3-A Sanitary, and FDA Standards, and is used for transmission of raw and pasteurized milk and other high water content dairy items.

Construction Tube

Clear Pliovic® (FDA, 3-A, USDA compliant), NSF-61

Cover

Clear Pliovic® (corrugated construction)

Reinforcement

Clear high-density rigid Pliovic® helix

Temperature Range

-15°F to 158°F (-26°C to 70°C)

Packaging

100' length, coiled, polywrapped

Branding

Not branded

Couplings

Contact fitting manufacturer for proper fitting recommendation and coupling procedure.

Order Codes

- 586-417 (white)
- 586-422 (clear)

Nutriflex™ Suction and Discharge

SAP #		ID		Nom. OD		Max. WP		Bend Radius		Vacuum HG		Weight	
White	Clear	in.	mm	in.	mm	psi	MPa	in.	mm	in.	mm	lb./ft.	kg/m
20013300	20013338	1	25.4	1.29	32.8	60	0.41	2	38	29	737	0.22	0.33
20013303	20013339	1¼	31.8	1.56	39.6	50	0.34	3	64	29	737	0.28	0.42
20013306	20013340	1½	38.1	1.88	47.8	50	0.34	4	81	29	737	0.31	0.46
20013309	20013341	2	50.8	2.43	61.7	40	0.28	4	81	29	737	0.51	0.76
20013311	20013342	2½	63.5	3.00	76.2	35	0.24	5	114	29	737	0.82	1.22
20013313	20013343	3	76.2	3.58	90.9	35	0.24	7	165	29	737	1.05	1.56
20013315	20013344	4	101.6	4.71	119.6	35	0.24	10	264	29	737	1.67	2.49
20118679	20013345	6	152.4	6.72	170.7	25	0.17	30	747	29	737	2.27	3.38

For Continental ContiTech food hose compliance information, see Appendix C.

Nutriflex™ Static Wire



Product Specifications

Application

For handling almost every type of dry bulk food material or liquid in gravity flow and vacuum service. Nutriflex™ Static Wire conforms to USDA Meat and Poultry, 3-A Sanitary, and FDA Standards, and is recommended for transmission of powder pellets or granular materials.

Construction Tube

Clear Pliovic® (FDA, 3-A, USDA compliant), NSF-61

Cover

Clear Pliovic® (corrugated construction) static wire placed between the tube and cover

Reinforcement

Clear, high-density Pliovic® helix

Temperature Range

-15°F to 158°F (-26°C to 70°C)

Packaging

100' length, coiled, polywrapped

Branding

Not branded

Couplings

Contact fitting manufacturer for proper fitting recommendation and coupling procedure.

Order Codes

586-472

Nutriflex™ Static Wire

SAP #	ID		Nom. OD		Max. WP		Bend Radius		Vacuum HG		Weight	
	in.	mm	in.	mm	psi	MPa	in.	mm	in.	mm	lb./ft.	kg/m
20050287	1¼	31.8	1.56	39.6	50	0.34	3	64	29	737	0.29	0.43
20013602	1½	38.1	1.84	46.8	50	0.34	4	81	29	737	0.36	0.54
20119161	1¾	44.5	2.09	53.1	45	0.31	4	81	29	737	0.40	0.60
20013603	2	50.8	2.43	61.7	40	0.28	4	89	29	737	0.52	0.77
20013604	2½	63.5	3.00	76.2	35	0.24	5	114	29	737	0.80	1.19
20013605	3	76.2	3.58	90.9	35	0.24	7	165	29	737	1.09	1.62
20013606	4	101.6	4.65	118.1	35	0.24	11	264	29	737	1.51	2.25
20013607	5	127.0	5.75	146.1	35	0.24	22	559	29	737	2.15	3.20
20013608	6	152.4	6.87	174.5	25	0.17	30	747	28	711	2.98	4.43

For Continental ContiTech food hose compliance information, see Appendix C.

Air & Multipurpose
General Purpose
Heavy Duty
Push-on

Chemical Transfer

Cleaning Equipment

Food Transfer Washdown

Marine

Material Handling
Abrasives
Bulk Transfer
Cement & Concrete

Mining

Petroleum
Aircraft Fueling
Dispensing
Dock Transfer

Spray

Steam

Vacuum

LPG Delivery

Water
Discharge
Suction & Discharge Washdown

Welding

Coupling Systems

Equipment

Appendix

Plicord® Blue Flour



Air & Multipurpose
 General Purpose
 Heavy Duty
 Push-on

Chemical Transfer

Cleaning Equipment

Food
 Transfer
 Washdown

Marine

Material Handling
 Abrasives
 Bulk Transfer
 Cement & Concrete

Mining

Petroleum
 Aircraft Fueling
 Dispensing
 Dock
 Transfer

Spray

Steam

Vacuum

LPG Delivery

Water
 Discharge
 Suction & Discharge
 Washdown

Welding

Coupling Systems

Equipment

Appendix

Product Specifications

Application

Tank truck or in-plant service hose is for discharge transfer of abrasive materials and dry foods such as flour, cake mixes, etc.

Construction Tube

3/16" gauge white Pureten™ tube (FDA compliant)

Cover

Blue SBR rubber (wrapped impression)

Reinforcement

Spiral-plied synthetic fabric with 2 antistatic wires

Temperature Range

-40°F to 180°F (-40°C to 82°C)

Packaging

100' length, coiled, polywrapped

Branding (Spiral)

Example: Continental ContiTech Plicord® Blue Flour Discharge FDA 150 psi

Couplings

Contact fitting manufacturer for proper fitting recommendation and coupling procedure.

Order Codes

549-503

Plicord® Blue Flour

SAP #	ID		Nom. OD		Max. WP		Weight	
	in.	mm	in.	mm	psi	MPa	lb./ft.	kg/m
20019792	2	50.8	2.68	68.1	150	1.03	1.39	2.07
20019794	3	76.2	3.69	93.7	150	1.03	2.02	3.01
20019795	4	101.6	4.71	119.6	150	1.03	2.63	3.91
20019796	5	127.0	5.72	145.3	150	1.03	3.27	4.87

For Continental ContiTech food hose compliance information, see Appendix C.

Plicord® Brewline



Product Specifications

Application

A quality discharge hose designed specifically for the highly demanding service of transferring non-oily liquid products in wineries and breweries.

Construction Tube

White chlorobutyl rubber (FDA/USDA compliant and conforms to 3-A Sanitary Standard 18-03)

Cover

Red EPDM with a white spiral stripe (wrapped impression)

Reinforcement

Spiral-plied synthetic fabric, 4 plies to 1½" ID; 6 plies over 1½" ID

Temperature Range

-40°F to 220°F (-40°C to 104°C)

Packaging

100' length, coiled, polywrapped

Branding

Example: Continental ContiTech Plicord® Brewline® hose 250 psi; FDA, 3-A and USDA

Couplings

Contact fitting manufacturer for proper fitting recommendation and coupling procedure.

Order Codes

549-885 Red Cover
549-003 Microban with Red Cover

Plicord® Brewline

SAP #	ID		Nom. OD		Max. WP		Weight	
	in.	mm	in.	mm	psi	MPa	lb./ft.	kg/m
20020324	3/4	19.1	1.34	34.0	250	1.72	0.54	0.80
20020327	1	25.4	1.69	42.9	250	1.72	0.81	1.21
20032192	1¼	31.8	2.00	50.8	250	1.72	1.05	1.56
20020335	1½	38.1	2.23	56.6	250	1.72	1.19	1.77
20020341	2	50.8	2.88	73.2	250	1.72	1.86	2.77
20020345	2½	63.5	3.51	89.2	250	1.72	2.66	3.96
20020348	3	76.2	4.09	103.9	250	1.72	3.57	5.31
20020352	4	101.6	5.31	134.9	250	1.72	5.43	8.08

For Continental ContiTech food hose compliance information, see Appendix C.



Air & Multipurpose
General Purpose
Heavy Duty
Push-on

Chemical Transfer

Cleaning Equipment

Food Transfer Washdown

Marine

Material Handling
Abrasives
Bulk Transfer
Cement & Concrete

Mining

Petroleum
Aircraft Fueling
Dispensing
Dock
Transfer

Spray

Steam

Vacuum

LPG Delivery

Water
Discharge
Suction & Discharge
Washdown

Welding

Coupling Systems

Equipment

Appendix

Plicord® ExtremeFlex™ Food Grade



Air & Multipurpose

- General Purpose
- Heavy Duty
- Push-on

Chemical Transfer

Cleaning Equipment

Food

- Transfer
- Washdown

Marine

Material Handling

- Abrasives
- Bulk Transfer
- Cement & Concrete

Mining

Petroleum

- Aircraft Fueling
- Dispensing
- Dock Transfer

Spray

Steam

Vacuum

LPG Delivery

Water

- Discharge
- Suction & Discharge
- Washdown

Welding

Coupling Systems

Equipment

Appendix

Product Specifications

Application

A high-tech, flexible corrugated hose with pretzel-like agility and proven performance. Best of all, it is available at a non-corrugated price, making it a great value. With ExtremeFlex™, there's even more to appreciate:

- › **Flexible Handling:** Easier to move in and out of tight spaces and around sharp corners.
- › **Lightweight:** Easier to lift and carry, so there are fewer workplace injuries.
- › **Lower Force to Bend:** Easier to connect and disconnect, keeping productivity high.

Construction Tube

White Chemivic™ synthetic rubber (FDA/USDA compliant and conforms to 3-A Sanitary Standard 18-03)

Cover

White or gray Chemivic™ corrugated synthetic rubber (wrapped impression)

Reinforcement

Spiral-plied synthetic fabric with galvanized wire helix

Temperature Range

-25°F to 212°F (-32°C to 100°C)

Packaging

Coiled and polywrapped

Branding (Spiral)

Continental ContiTech Plicord® ExtremeFlex™ Food Grade 150 psi WP

Couplings

Contact fitting manufacturer for proper fitting recommendations and coupling procedure

Non-Stock/Sizes

400' minimum order

Order Codes

- 549-462 (white)
- 549-164 (gray)

Plicord® ExtremeFlex™ Food Grade

SAP #		ID		Nom. OD		Max. WP		Bend Radius		Vacuum HG		Weight	
White	Gray	in.	mm	in.	mm	psi	MPa	in.	mm	in.	mm	lb./ft.	kg/m
20478040	20483718	2	51.2	2.4	62.0	150	1.03	2	51	29	737	1.00	1.48
20478043	20483781	3	76.1	3.5	89.9	150	1.03	3	76	29	737	1.89	2.79
20478044	20483782	4	102.1	4.6	116.6	150	1.03	4	102	29	737	2.69	3.98

For Continental ContiTech food hose compliance information, see Appendix C.



Plicord® Winline®



Product Specifications

Application

A quality, non-toxic hose for handling wine, potable water, and other non-oily liquid food products where the hose must meet FDA requirements. For discharge service and suction service up to 20" hg vacuum at ambient temperature.

Construction Tube

White chlorobutyl rubber (FDA/USDA compliant and conforms to 3-A Sanitary Standard 18-03)

Cover

White EPDM rubber with a purple spiral stripe (wrapped impression)

Reinforcement

Spiral-plied synthetic fabric, 4 plies to 1½" ID; 6 plies over 1½" ID

Temperature Range

-40°F to 220°F (-40°C to 104°C)

Packaging

100' length, coiled, polywrapped

Branding (Spiral)

Example: Continental ContiTech Plicord® Winline® hose 250 psi; FDA, 3-A, and USDA

Couplings

Contact fitting manufacturer for proper fitting recommendation and coupling procedure.

Order Codes

549-887

Plicord® Winline®

SAP #	ID		Nom. OD		Max. WP		Weight	
	in.	mm	in.	mm	psi	MPa	lb./ft.	kg/m
20020367	3/4	19.1	1.39	35.3	250	1.72	0.60	0.89
20020371	1	25.4	1.69	42.9	250	1.72	0.80	1.19
20099578	1¼	31.8	2.00	50.8	250	1.72	1.04	1.55
20020376	1½	38.1	2.23	56.6	250	1.72	1.20	1.79
20020379	2	50.8	2.92	74.2	250	1.72	1.98	2.95
20020380	2½	63.5	3.50	88.9	250	1.72	2.65	3.94
20020382	3	76.2	4.09	103.9	250	1.72	3.55	5.28
20031599	4	101.6	5.30	134.6	250	1.72	5.40	8.04

For Continental ContiTech food hose compliance information, see Appendix C.

Air & Multipurpose
General Purpose
Heavy Duty
Push-on

Chemical Transfer

Cleaning Equipment

Food
Transfer
Washdown

Marine

Material Handling
Abrasives
Bulk Transfer
Cement & Concrete

Mining

Petroleum
Aircraft Fueling
Dispensing
Dock
Transfer

Spray

Steam

Vacuum

LPG Delivery

Water
Discharge
Suction & Discharge
Washdown

Welding

Coupling Systems

Equipment

Appendix

Pliovic® FG (FDA-3A)



Air & Multipurpose
 General Purpose
 Heavy Duty
 Push-on

Chemical Transfer

Cleaning Equipment

Food
 Transfer
 Washdown

Marine

Material Handling
 Abrasives
 Bulk Transfer
 Cement & Concrete

Mining

Petroleum
 Aircraft Fueling
 Dispensing
 Dock
 Transfer

Spray

Steam

Vacuum

LPG Delivery

Water
 Discharge
 Suction & Discharge
 Washdown

Welding

Coupling Systems

Equipment

Appendix

Product Specifications

Application

A versatile, lightweight, reinforced tubing for the food and beverage, general air, multipurpose, pharmaceutical and cosmetics industries; computer component manufacturers; textile mills; and air-actuated equipment.

Construction Tube

Clear Pliovic® compound, conforms to FDA, USDA, NSF-61 and 3-A standards

Cover

Clear Pliovic® compound, conforms to FDA, USDA, NSF-61 and 3-A standards

Reinforcement

Spiral synthetic yarn

Temperature Range

-10°F to 158°F (-23°C to 70°C)

Packaging

1/4"-5/8" - 300' Bagel Pack, one piece
 3/4" and 1" - 200' Bagel Pack, one piece

Branding

Example: Continental ContiTech Pliovic® FG FDA & 3-A Compliant 3/8" ID (9.5mm) 250 psi WP (1.7 MPa). Made in U.S.A.

Couplings

Contact fitting manufacturer for proper fitting recommendations and coupling procedure

Non-Stock/Sizes

Contact customer service for availability on cut, coiled and tied hose lengths.

Order Codes

540-337

Pliovic® FG (FDA-3A)

SAP #	ID		Nom. OD		Max. WP		Weight	
	in.	mm	in.	mm	psi	MPa	lb./ft.	kg/m
20129509	1/4	6.4	0.44	11.2	250	1.72	0.05	0.07
20129600	5/16	7.9	0.50	12.7	250	1.72	0.07	0.10
20129601	3/8	9.5	0.59	15.0	250	1.72	0.08	0.12
20129602	1/2	12.7	0.75	19.1	200	1.38	0.12	0.18
20129603	5/8	15.9	0.87	22.1	200	1.38	0.15	0.22
20337878	3/4	19.1	1.02	25.9	150	1.03	0.19	0.28
20316305	1	25.4	1.34	34.0	125	0.86	0.31	0.46
20463346	1¼	31.75	1.72	43.6	125	0.86	0.60	0.89
20463340	1½	38.1	1.98	50.2	125	0.86	0.72	1.07

For Continental ContiTech food hose compliance information, see Appendix C.

Potable Water



Product Specifications

Application

Designed to handle water suitable for drinking. Used in oilfield or industrial applications. Used in discharge service only. This hose is not NSF approved.

Construction Tube

White natural rubber (complies with FDA requirements)

Cover

Blue SBR (smooth, wrapped impression)

Reinforcement

Synthetic textile fabric plies

Temperature Range

-40°F to 180°F (-40°C to 82°C)

Packaging

Coiled-polyethylene wrapped/bagel pack

Branding (Spiral)

Example: Continental ContiTech Potable Water Hose

Couplings

Contact fitting manufacturer for proper fitting recommendation and coupling procedure.

Order Codes

542-445

Potable Water

SAP #	ID		Nom. OD		Max. WP		Weight	
	in.	mm	in.	mm	psi	MPa	lb./ft.	kg/m
20016702	1	25.4	1.49	37.9	250	1.72	0.55	0.82
20016704	1½	38.1	1.98	50.3	250	1.38	0.77	1.15
20016706	2	50.8	2.50	63.5	150	1.03	0.96	1.43
20344236	3	76.2	3.58	91.0	150	1.03	1.72	2.56
20016709	4	101.6	4.56	115.8	150	1.03	1.99	2.96

For Continental ContiTech food hose compliance information, see Appendix C.

Air & Multipurpose

General Purpose
Heavy Duty
Push-on

Chemical Transfer

Cleaning Equipment

Food
Transfer
Washdown

Marine

Material Handling

Abrasives
Bulk Transfer
Cement & Concrete

Mining

Petroleum

Aircraft Fueling
Dispensing
Dock
Transfer

Spray

Steam

Vacuum

LPG Delivery

Water

Discharge
Suction & Discharge
Washdown

Welding

Coupling Systems

Equipment

Appendix

Vintner™



Air & Multipurpose

- General Purpose
- Heavy Duty
- Push-on

Chemical Transfer

Cleaning Equipment

Food
Transfer
Washdown

Marine

Material Handling

- Abrasives
- Bulk Transfer
- Cement & Concrete

Mining

Petroleum

- Aircraft Fueling
- Dispensing
- Dock
- Transfer

Spray

Steam

Vacuum

LPG Delivery

Water

- Discharge
- Suction & Discharge
- Washdown

Welding

Coupling Systems

Equipment

Appendix



Product Specifications

Application

For handling in-plant and/or tank truck transfer of wine, beer, potable water and other non-oily, liquid foodstuffs.

Construction Tube

White chlorobutyl (FDA/USDA compliant and conforms to 3-A Sanitary Standard 18-03)

Cover

Gray EPDM synthetic rubber (wrapped) / purple branding tape

Reinforcement

Spiral-ply synthetic fabric with Monofilament Helix

Temperature Range

-30°F to 220°F (-34°C to 104°C)

Packaging

100' length, coiled, polywrapped

Branding (Spiral)

Example: Continental ContiTech Plicord® Vintner™ 250 psi; FDA, 3-A, and USDA

Couplings

Contact fitting manufacturer for proper fitting recommendations and coupling procedure

Non-Stock/Sizes

Contact customer service for availability on cut, coiled and tied hose lengths.

Order Codes

- 549-886 White Cover
- 549-009 Red Microban Cover

Vintner™

SAP #	ID	Nom. OD		Max. WP		Bend Radius		Vacuum HG		Weight		
		in.	mm	in.	mm	in.	mm	in.	mm	lb./ft.	kg/m	
20020354	1	25.4	1.62	41.1	250	1.72	3	76	27	686	0.71	1.06
20020356	1½	38.1	2.11	53.6	250	1.72	4	102	27	686	0.98	1.46
20020361	2	50.8	2.68	68.1	250	1.72	7	178	27	686	1.38	2.05
20020362	2½	63.5	3.21	81.5	250	1.72	10	254	27	686	1.78	2.65
20020365	3	76.2	3.85	97.8	250	1.72	12	305	27	686	2.59	3.86

For Continental ContiTech food hose compliance information, see Appendix C.

EZ GLIDE WINE™



Product Specifications

Application

EZ Glide Wine by ContiTech is a quality, nontoxic hose for handling wine, potable water, and other non oily liquid food products where the hose must meet FDA requirements. For discharge service and suction service up to 20" hg vacuum at ambient temperature.

Construction Tube

White chlorobutyl rubber (FDA/USDA compliance and conforms to 3-A sanitary standard 18-03), non-phthalates compound

Cover

Grey Chemivic® rubber and green outer helix

Reinforcement

Synthetic fabric piles

Temperature Range

-20 F to 180 F (Max 200 for cleaning purposes only)

Branding (Spiral)

Example: Continental ContiTech Vintner™ hose

Couplings

Contact fitting manufacturer for proper fitting recommendations and coupling procedure

Order Codes

549-646

Vintner™

SAP #	ID		Nom. OD		Max. WP		Bend Radius		Vacuum HG		Weight	
	in.	mm	in.	mm	psi	MPa	in.	mm	in.	mm	lb./ft.	kg/m
20829361	1½	38.1	2.06	52.4	150	1	3	76	20	508	.93	1.38
20829362	2	50.8	2.59	65.9	150	1	3	76	20	508	1.22	1.88
20829262	3	76.2	3.61	91.7	150	1	5	127	20	508	1.85	2.74

Air & Multipurpose

General Purpose
Heavy Duty
Push-on

Chemical Transfer

Cleaning Equipment

Food Transfer Washdown

Marine

Material Handling

Abrasives
Bulk Transfer
Cement & Concrete

Mining

Petroleum

Aircraft Fueling
Dispensing
Dock
Transfer

Spray

Steam

Vacuum

LPG Delivery

Water

Discharge
Suction & Discharge
Washdown

Welding

Coupling Systems

Equipment

Appendix

Plicord® ExtremeFlex™ Beverage Gray



Air & Multipurpose
 General Purpose
 Heavy Duty
 Push-on

Chemical Transfer

Cleaning Equipment

Food
 Transfer
 Washdown

Marine

Material Handling
 Abrasives
 Bulk Transfer
 Cement & Concrete

Mining

Petroleum
 Aircraft Fueling
 Dispensing
 Dock
 Transfer

Spray

Steam

Vacuum

LPG Delivery

Water
 Discharge
 Suction & Discharge
 Washdown

Welding

Coupling Systems

Equipment

Appendix

Product Specifications

Application

For beer, wine, distillery and beverage (edible liquid) transfer processing facilities. Ideal for applications requiring flexible and/or tight bend connections.

Construction Tube

White Chlorobutyl (FDA/USDA compliant & conforms to a 3-A Sanitary Standard 18-03)

Cover

Corrugated gray chemical (wrapped impression)

Reinforcement

Spiral-plied fabrics with double galvanized helix wire

Temperature Range

-30°F to 220°F (-34°C to 104°C)

Couplings

Tri-Clamp or Sanitary ends are typically used with this hose

Order Codes

549-603 Gray Cover

549-004 Red Microban Cover

Plicord® ExtremeFlex™ Beverage Gray

Part #	ID		Nom. OD		Max. WP		Bend Radius		Vacuum HG @ 72°F		Weight	
	in.	mm	in.	mm	psi	MPa	in.	mm	in.	mm	lb./ft.	kg/m
20762678	1	25.4	1.56	39.7	250	1.72	1.5	38	29	737	0.73	1.09
20762679	1½	38.1	2.02	51.3	250	1.72	2.3	57	29	737	0.92	1.38
20762751	2	50.8	2.53	64.2	250	1.72	3.0	76	29	737	1.20	1.79
20762752	3	76.2	3.59	91.2	200	1.38	4.5	114	29	737	2.02	3.01
20762753	4	101.6	4.60	116.8	150	1.03	6.0	152	29	737	2.76	4.11

Plicord® ExtremeFlex™ Beverage Red with EZ Clean Cover



Product Specifications

Application

For beer, wine, distillery and beverage (edible liquid) transfer processing facilities. Ideal for applications requiring flexible and/or tight bend connections.

Construction Tube

White Chlorobutyl (FDA/USDA compliant & conforms to a 3-A Sanitary Standard 18-03)

Cover

Corrugated grey chemical (wrapped impression), New corrugated red EZ Clean UHMWPE cover (semi-smooth finish)

Reinforcement

Spiral-plied fabrics with double galvanized helix wire

Temperature Range

-30°F to 220°F (-34°C to 104°C)

Couplings

Tri-Clamp or Sanitary ends are typically used with this hose

Order Codes

549-605 EZ Clean Red Cover

Plicord® ExtremeFlex™ Beverage Red

Part #	ID		Nom. OD		Max. WP		Bend Radius		Vacuum HG @ 72°F		Weight	
	in.	mm	in.	mm	psi	MPa	in.	mm	in.	mm	lb./ft.	kg/m
20776605	1	25.4	1.52	38.7	250	1.72	2	51	29	737	0.65	0.96
20762754	1½	38.1	2.03	51.6	250	1.72	3	76	29	737	0.93	1.38
20752524	2	50.8	2.537	64.5	250	1.72	4	102	29	737	1.21	1.80
20762758	3	76.2	3.601	91.5	200	1.38	6	152	29	737	2.03	3.02
20762760	4	101.6	4.607	117	150	1.03	8	203	29	737	2.77	4.12

Air & Multipurpose
General Purpose
Heavy Duty
Push-on

Chemical Transfer

Cleaning Equipment

Food
Transfer
Washdown

Marine

Material Handling
Abrasives
Bulk Transfer
Cement & Concrete

Mining

Petroleum
Aircraft Fueling
Dispensing
Dock
Transfer

Spray

Steam

Vacuum

LPG Delivery

Water
Discharge
Suction & Discharge
Washdown

Welding

Coupling Systems

Equipment

Appendix

Tan Flexwing®



Air & Multipurpose
 General Purpose
 Heavy Duty
 Push-on

Chemical Transfer

Cleaning Equipment



Product Specifications

Application

Tan Flexwing® is for acids, alcohol bases and salt solutions.

Construction Tube

Tan Pureten™ gum rubber (non oil-resistant) (FDA/USDA compliant)

Cover

Tan SBR synthetic rubber (non oil-resistant) with blue spiral stripe (wrapped impression)

Reinforcement

Spiral-plyed synthetic fabric with wire helix

Temperature Range

-40°F to 180°F (-40°C to 82°C)

Packaging

100' lengths, coiled and polywrapped

Branding (Spiral)

Example: Continental ContiTech Tan Flexwing® with Pureten™ 150 psi WP

Couplings

Contact fitting manufacturer for proper fitting recommendation and coupling procedure.

Order Codes

549-986

Food
 Transfer
 Washdown

Marine

Material Handling
 Abrasives
 Bulk Transfer
 Cement & Concrete

Mining

Petroleum
 Aircraft Fueling
 Dispensing
 Dock
 Transfer

Spray

Steam

Vacuum

LPG Delivery

Water
 Discharge
 Suction & Discharge
 Washdown

Welding

Coupling Systems

Equipment

Appendix

Tan Flexwing®

Material	ID		Nom. OD		Max. WP		Bend Radius		Vacuum HG		Weight	
	in.	mm	in.	mm	psi	MPa	in.	mm	in.	mm	lb./ft.	kg/m
20790764	2	50.8	2.68	68.1	150	1.03	5.0	127	29	737	1.44	2.14
20790765	3	76.2	3.75	95.3	150	1.03	7.0	178	29	737	2.32	3.45
20790766	4	101.6	4.83	122.7	150	1.03	10.0	254	29	737	3.39	5.04

Tan Flextra®



Product Specifications

Application

For tank truck and in-plant service. Used to convey non-oily abrasive materials such as sand, limestone, plastic pellets and dry abrasive food products

Construction Tube

Pureten™ gum rubber (non oil-resistant) (FDA/USDA compliant)

Cover

Tan SBR gum rubber (corrugated) with yellow spiral stripe (wrapped impression)

Reinforcement

Spiral-plied synthetic fabric with wire helix

Temperature Range

-40°F to 180°F (-40°C to 82°C)

Packaging

100' length, coiled, polywrapped

Branding (Spiral)

Example: Continental ContiTech Tan Flextra® with Pureten™ 75 psi WP

Couplings

Contact fitting manufacturer for proper fitting recommendations and coupling procedure

Non-Stock/Sizes

Contact customer service for availability on cut, coiled and tied hose lengths.

Order Codes

549-987

Tan Flextra®

Material	ID		Nom. OD		Max. WP		Bend Radius		Vacuum HG		Weight	
	in.	mm	in.	mm	psi	MPa	in.	mm	in.	mm	lb./ft.	kg/m
20790761	2	50.8	2.60	66.0	75	0.52	4	102	29	737	1.21	1.80
20790762	3	76.2	3.63	92.2	75	0.52	6	152	29	737	1.94	2.89
20790763	4	101.6	4.69	119.1	75	0.52	9	229	29	737	2.74	4.08

Air & Multipurpose

General Purpose
Heavy Duty
Push-on

Chemical Transfer

Cleaning Equipment

Food
Transfer
Washdown

Marine

Material Handling

Abrasives
Bulk Transfer
Cement & Concrete

Mining

Petroleum

Aircraft Fueling
Dispensing
Dock
Transfer

Spray

Steam

Vacuum

LPG Delivery

Water

Discharge
Suction & Discharge
Washdown

Welding

Coupling Systems

Equipment

Appendix

Tan Softwall



Air & Multipurpose
 General Purpose
 Heavy Duty
 Push-on

Chemical Transfer

Cleaning Equipment



Product Specifications

Application

A fabric-reinforced hose for the discharge of non-oily abrasive materials such as sand, limestone, gravel, plastic pellets and dry food products. For use where static electrical buildup is not a problem.

Construction Tube

Tan Pureten™ gum rubber (FDA/USDA compliant)

Cover

Tan SBR synthetic rubber (wrapped impression)

Reinforcement

Spiral-plied synthetic fabric with static wire

Temperature Range

-40°F to 180°F (-40°C to 82°C)

Packaging

100' lengths, coiled and polywrapped

Branding (Spiral)

Example: Continental ContiTech Tan Softwall with Pureten™ 75 psi WP

Couplings

Contact fitting manufacturer for proper fitting recommendation and coupling procedure.

Order Codes

549-988

Tan Softwall

Material	ID		Nom. OD		Max. WP		Weight	
	in.	mm	in.	mm	psi	MPa	lb./ft.	kg/m
20790767	3	76.2	3.69	93.7	75	0.52	1.80	2.68
20790768	4	101.6	4.78	121.4	75	0.52	2.61	3.88

Food Transfer Washdown

Marine

Material Handling
 Abrasives
 Bulk Transfer
 Cement & Concrete

Mining

Petroleum
 Aircraft Fueling
 Dispensing
 Dock Transfer

Spray

Steam

Vacuum

LPG Delivery

Water
 Discharge
 Suction & Discharge
 Washdown

Welding

Coupling Systems

Equipment

Appendix

Velocity Beverage Transfer Hose



Product Specifications

Application

Velocity (BT) Beverage Transfer has USDA, FDA and NSF approved materials. Ideal for applications needing lightweight, flexible PVC hose such as wineries and microbreweries

Construction Tube

Clear Pliovic compound, conforms to FDA, USDA and 3-A standards

Cover

Clear Pliovic compound

Reinforcement

Polyester synthetic yarn

Helix

White rigid PVC compound

Temperature Range

-13°F to 140°F (-25°C to 60°C)

Order Codes

591-103

Velocity Beverage Transfer Hose

Material	ID		Nom. OD		Max. WP		Weight		Vacuum		Bend Radius
	in.	mm	in.	mm	psi	MPa	lb./ft.	kg/m	in.	mm	in.
20806470	1.5	38.1	2.03	51.7	110	0.76	0.65	0.97	29	737	2.5
20806471	2	50.8	2.46	62.5	100	0.69	0.71	1.06	29	737	4
20806472	3	76.2	3.71	94.2	100	0.69	1.42	2.12	29	737	6
20810398	4	101.6	4.75	120.6	75	0.52	1.85	2.75	29	737	7

Air & Multipurpose

General Purpose
Heavy Duty
Push-on

Chemical Transfer

Cleaning Equipment

Food Transfer Washdown

Marine

Material Handling

Abrasives
Bulk Transfer
Cement & Concrete

Mining

Petroleum

Aircraft Fueling
Dispensing
Dock
Transfer

Spray

Steam

Vacuum

LPG Delivery

Water

Discharge
Suction & Discharge
Washdown

Welding

Coupling Systems

Equipment

Appendix

Food Transfer

Food Hose Recommendation Guide - Specific Hose Application Capabilities

	Tube: Compound	Chemivic	Pureten	Pureten	Chlorobutyl	Pliovic
Air & Multipurpose	Tube: Color	White	Tan	White	White	Clear
General Purpose	Hose Name	White Flexwing, White Flextra, Gray Flextra LT, Gray Food White Softwall	Flexwing, Tan Flextra, Tan Softwall	Blue Flour Discharge, Harvest	Wineline, Brewline, Vintner	Pliovic FG, Nutriflo, Nutriflex, Nutriflex SW
Heavy Duty						
Push-on						
Chemical Transfer						
Cleaning Equipment						
Food Transfer Washdown	Food					
Marine	(B)					
	Beet Sugar, Granular	I	A	A	X	B
	Buttermilk, Dried	X	A	A	X	B
	(C)					
	Cane Sugar, Granular	I	A	A	X	B
	Cashew Nut Oil	A	X	X	X	X
	Castor Oil	A	X	X	X	X
	Citric Acid	A	A	A	A	B
	Cocoa Butter	A	X	X	X	I
	Coconut Oil	A	X	X	X	X
	Corn Oil	A	X	X	X	X
	Cottonseed Oil	A	X	X	X	X
	(F)					
	Fish Meal	A	X	X	X	B
	Flour	I	A	A	X	
	(G)					
	Grape Juice	A	X	X	A	B
	(L)					
	Lactic Acid	A	B	B	B	X
	Lard Oil	A	X	X	X	X
	Linseed Oil	A	X	X	X	X
	Liquor (Spirits)	B	X	X	X	B
	(M)					
	Milk	A	X	X	A	B
	Mineral Oil	A	X	X	X	B
	Molasses	A	A	A	A	A
	(O)					
	Olive Oil	A	X	X	X	X
	Orange Juice	A	X	X	A	A
	(P)					
	Palm Oil	A	X	X	X	X
	Paraffin	A	X	X	X	B
	Peanut Oil	A	X	X	X	X
	Potato Flour	I	A	A	A	A
	(S)					
	Salt, Granular, Table Grade	I	A	A	X	A
	Shortening	A	X	X	X	I
	Soybean Oil	A	X	X	X	X
	Sucrose	A	A	A	X	A
	Sugar, Granulated	I	A	A	X	A
	Sugar, Syrup	A	A	A	A	A
	(T)					
	Tallow	A	X	X	X	X
	Tomato Juice, Paste & Puree Sauce	A	X	X	I	B
	(V)					
	Vegetable Oil	A	X	X	X	X
	Vinegar	A	X	X	A	A
	(W)					
	Water, Potable	A	X	X	A	A
	Whiskey	B	X	X	X	X
	Wine	A	X	X	A	I

Key: A - Excellent; B - Good; X - Not recommended; I - Insufficient information.

Note: For temperatures in excess of 150°F (66°C), consult Customer Service.

Food Washdown



	Page	Non-Marking	Superior Oil Resisance Tube and Cover	Superior Abrasion Cover	Anti Microbial Cover	Tapered Nozzle	Wire	Textile
Blue Fortress 300	96	Yes	Yes	Yes	Yes			Yes
Fortress 300	93	Yes	Yes	Yes	Yes			Yes
Fortress 1000	94	Yes	Yes	Yes	Yes			Yes
Fortress 3000	95	Yes	Yes	Yes	Yes		Yes	
Gauntlet 1500	62	Yes*	Yes	Yes				Yes
Plicord Washdown	262					Yes		Yes
Sani-Wash 300	98	Yes						Yes
Sani-Wash Plus 300	97	Yes	Yes					Yes
Super Sani-Wash 300	99	Yes			Yes			Yes

*Non-black colors.

Air & Multipurpose
 General Purpose
 Heavy Duty
 Push-on

Chemical Transfer

Cleaning Equipment

Food
 Transfer
 Washdown

Marine

Material Handling
 Abrasives
 Bulk Transfer
 Cement & Concrete

Mining

Petroleum
 Aircraft Fueling
 Dispensing
 Dock
 Transfer

Spray

Steam

Vacuum

LPG Delivery

Water
 Discharge
 Suction & Discharge
 Washdown

Welding

Coupling Systems

Equipment

Appendix

Fortress® 300 with Microban® Product Protection



Air & Multipurpose
General Purpose
Heavy Duty
Push-on

Chemical Transfer

Cleaning Equipment



Food
Transfer
Washdown

Marine

Material Handling
Abrasives
Bulk Transfer
Cement & Concrete

Mining

Petroleum
Aircraft Fueling
Dispensing
Dock
Transfer

Spray

Steam

Vacuum

LPG Delivery

Water
Discharge
Suction & Discharge
Washdown

Welding

Coupling Systems

Equipment

Appendix

Product Specifications

Application

A high-quality construction for hot water up to 200°F (93°C) for cleanup service in food processing plants, dairies, packing houses, bottling plants, breweries, canneries and creameries. Its super abrasion and oil-resistant cover provides maximum protection against the adverse effects of oil and animal fats. The cover of our Fortress® 300 hose incorporates Microban's** antimicrobial built-in product protection.

Construction Tube

Black Nitrile synthetic rubber

Cover

Yellow Carbryn™ synthetic rubber, RMA Class A (High Oil Resistance) with Microban® product protection

Reinforcement

Spiral synthetic yarn

Temperature Range

-20°F to 200°F (-29°C to 93°C)

Packaging

1/2"-3/4" - 500' reels, maximum 3 pieces, 50' increments
1" - 450' reels, maximum 3 pieces, 50' increments

Fortress® 300

SAP #	ID		Nom. OD		Max. WP		Weight	
	in.	mm	in.	mm	psi	MPa	lb./ft.	kg/m
20135640	1/2	12.7	0.90	22.8	300	2.07	0.29	0.43
20135644	5/8	15.9	1.06	27.0	300	2.07	0.36	0.54
20135645	3/4	19.1	1.19	30.2	300	2.07	0.41	0.61
20135646	1	25.4	1.50	38.1	300	2.07	0.60	0.89

*Microban® antimicrobial product protection inhibits the growth of bacteria, mold and fungi that can cause odor, stains or degradation of the hose cover.

Microban® is intended to protect the hose cover only. It is not a substitute for good sanitary practices.

Branding

Example: Fortress® 300 with Microban® Antimicrobial Product Protection 3/8" 300 psi WP. Made in U.S.A. Continental ContiTech

Couplings

Use Continental ContiTech pressure washing fittings with this product. See the Coupling Systems information pages at the back of the catalog for available sizes. Refer to the Continental ContiTech Hose Assembly Manual for crimp procedures. Coupled lengths with MxMS fittings and Kink Guards available.

Non-Stock/Sizes

Contact customer service for availability on cut, coiled and tied hose lengths.

Order Codes

569-120 (yellow)

Fortress® 1000 with Microban® Product Protection



Product Specifications

Application

For use on pressure washer machines with working pressures up to 1000 psi. Applications include washdown service in food processing plants, dairies, packing houses, bottling plants, breweries, canneries and creameries. Its super abrasion and oil-resistant cover provides maximum protection against the adverse effects of oil and animal fats. The cover of our Fortress® Washdown hose incorporates Microban's** antimicrobial built-in product protection.

Construction Tube

Nitrile synthetic rubber

Cover

Carbryn™ synthetic rubber, RMA Class A (High Oil Resistance) with Microban® product protection

Reinforcement

Braided (1) synthetic yarn

Temperature Range

-20°F to 200°F (-29°C to 93°C)

Packaging

500' reels, maximum 3 pieces, 50' increments: coupled lengths available

Branding

Example: Fortress® 1000 with Microban® Antimicrobial Product Protection 3/8" 1000 psi WP. Made in U.S.A. Continental ContiTech

Couplings

Contact fitting manufacturer for proper fitting recommendation and coupling procedure.

Order Codes

536-575 (yellow)
536-583 (red)
536-481 (blue)

Fortress® 1000

SAP #	ID		Nom. OD		Max. WP		Weight	
	in.	mm	in.	mm	psi	MPa	lb./ft.	kg/m
20451915	1/4	6.4	0.59	15.0	1000	6.9	0.12	0.18
20139345	3/8	9.5	0.75	19.1	1000	6.9	0.18	0.27
20141359	1/2	12.7	0.86	21.8	1000	6.9	0.20	0.30
20141420	3/4	19.1	1.20	30.5	1000	6.9	0.42	0.62

*Microban® Antimicrobial Product Protection inhibits the growth of bacteria, mold and fungi that can cause odor, stains or degradation of the hose cover.

Microban® is intended to protect the hose cover only. It is not a substitute for good sanitary practices.

Air & Multipurpose
General Purpose
Heavy Duty
Push-on

Chemical Transfer

Cleaning Equipment

Food
Transfer
Washdown

Marine

Material Handling
Abrasives
Bulk Transfer
Cement & Concrete

Mining

Petroleum
Aircraft Fueling
Dispensing
Dock
Transfer

Spray

Steam

Vacuum

LPG Delivery

Water
Discharge
Suction & Discharge
Washdown

Welding

Coupling Systems

Equipment

Appendix

Fortress® 3000 with Microban® Product Protection



Air & Multipurpose

General Purpose
Heavy Duty
Push-on

Chemical Transfer

Cleaning Equipment

Food
Transfer
Washdown

Marine

Material Handling

Abrasives
Bulk Transfer
Cement & Concrete

Mining

Petroleum

Aircraft Fueling
Dispensing
Dock
Transfer

Spray

Steam

Vacuum

LPG Delivery

Water

Discharge
Suction & Discharge
Washdown

Welding

Coupling Systems

Equipment

Appendix



Product Specifications

Application

Fortress® 3000 is for use on pressure washer machines with working pressures up to 3000 psi. Applications include washdown service in food processing plants, dairies, packing houses, bottling plants, breweries, canneries and creameries. Its super abrasion and oil-resistant cover provides maximum protection against the adverse effects of oil and animal fats. The cover of Fortress® Washdown hose incorporates Microban's** antimicrobial built-in product protection.

Construction Tube

Nitrile synthetic rubber

Cover

Carbryn™ synthetic rubber, RMA Class A (High Oil Resistance) with Microban® built-in product protection

Reinforcement

Braided (1) steel wire

Temperature Range

-20°F to 250°F (-29°C to 121°C)

Fortress® 3000

SAP #	ID		Nom. OD		Max. WP		Weight	
	in.	mm	in.	mm	psi	MPa	lb./ft.	kg/m
20141421	1/4	6.4	0.53	13.5	3000	20.69	0.15	0.22
20139340	3/8	9.5	0.69	17.5	3000	20.69	0.24	0.36
20141423	1/2	12.7	0.82	20.8	3000	20.69	0.32	0.48

*Microban® antimicrobial product protection inhibits the growth of bacteria, mold and fungi that can cause odor, stains or degradation of the hose cover.

Microban® is intended to protect the hose cover only. It is not a substitute for good sanitary practices.

Packaging

500' reel, maximum 3 pieces, 50' increments: coupled lengths available

Branding

Example: Fortress® 3000 with Microban® Antimicrobial Product Protection 3/8" 3000 psi WP. Made in U.S.A. Continental ContiTech

Couplings

Use Continental ContiTech pressure washing fittings with this product. See the Coupling Systems information pages at the back of the catalog for available sizes. Refer to the Continental ContiTech Hose Assembly Manual for crimp procedures. Coupled lengths with MxMS fittings and Kink Guards available.

Order Codes

539-400 (Yellow)
539-401 (Blue)

Blue Fortress® 300 with Microban® with FDA Compliant White Tube



Product Specifications

Application

A high-quality construction for hot water up to 200°F (93°C) cleanup service in food processing plants, dairies, packing houses, bottling plants, breweries, canneries and creameries. Its super abrasion and oil-resistant cover provides maximum protection against the adverse effects of oil and animal fats. The cover of our Blue Fortress® 300 hose incorporates Microban's® antimicrobial built-in product protection. The white tube is comprised of FDA compliant materials.

Construction Tube

White FDA compliant nitrile synthetic rubber

Cover

Blue Carbryn™ synthetic rubber, RMA Class A (High Oil Resistance) with Microban® product protection

Reinforcement

Spiral synthetic yarn

Temperature Range

-20°F to 200°F (-29°C to 93°C)

Packaging

Bulk

Branding

Example: Fortress® 300 with Microban® Antimicrobial Product Protection 3/4" 300 psi WP. Made in U.S.A. Continental ContiTech

Couplings

Contact fitting manufacturer for proper fitting recommendation and coupling procedure.

Order Codes

569-121

Blue Fortress® 300 with FDA Compliant White Tube

SAP #	ID		Nom. OD		Max. WP		Weight	
	in.	mm	in.	mm	psi	MPa	lb./ft.	kg/m
20189064	1/2	12.7	0.90	22.8	300	2.07	0.30	0.45
20630248	5/8	15.8	1.06	26.9	300	2.07	0.37	0.62
20190318	3/4	19.1	1.19	30.2	300	2.07	0.44	0.65
20459020	1	25.4	1.50	38.1	300	2.07	0.57	0.95

*Microban® antimicrobial product protection inhibits the growth of bacteria, mold and fungi that can cause odor, stains or degradation of the hose cover. Microban® is intended to protect the hose cover only. It is not a substitute for good sanitary practice.

Air & Multipurpose
General Purpose
Heavy Duty
Push-on

Chemical Transfer

Cleaning Equipment

Food
Transfer
Washdown

Marine

Material Handling
Abrasives
Bulk Transfer
Cement & Concrete

Mining

Petroleum
Aircraft Fueling
Dispensing
Dock
Transfer

Spray

Steam

Vacuum

LPG Delivery

Water
Discharge
Suction & Discharge
Washdown

Welding

Coupling Systems

Equipment

Appendix

Sani-Wash™ Plus 300



Air & Multipurpose

- General Purpose
- Heavy Duty
- Push-on

Chemical Transfer

Cleaning Equipment

Food
Transfer
Washdown

Marine

Material Handling

- Abrasives
- Bulk Transfer
- Cement & Concrete

Mining

Petroleum

- Aircraft Fueling
- Dispensing
- Dock
- Transfer

Spray

Steam

Vacuum

LPG Delivery

Water

- Discharge
- Suction & Discharge
- Washdown

Welding

Coupling Systems

Equipment

Appendix

Product Specifications

Application

A high-quality, economical construction for hot water up to 200°F (93°C) cleanup service in food processing plants, dairies, packing houses, bottling plants, breweries, canneries and creameries.

Construction Tube

Black Nitrile synthetic rubber, RMA Class A (High Oil Resistance), non-FDA

Cover

White Chemivic™ synthetic rubber, RMA Class A (High Oil Resistance)

Reinforcement

Spiral synthetic yarn

Temperature Range

-20°F to 200°F (-29°C to 93°C)

Packaging

1/2"-3/4" - 500' reels, maximum 3 pieces, 50' increments
1" - 450' reels, maximum 3 pieces, 50' increments

Branding

Example: Sani-Wash™ Plus (19.1mm) 300 psi WP. Made in U.S.A. Continental ContiTech

Couplings

Contact fitting manufacturer for proper fitting recommendation and coupling procedure.

Order Codes

569-019

Sani-Wash™ Plus 300

SAP #	ID		Nom. OD		Max. WP		Weight	
	in.	mm	in.	mm	psi	MPa	lb./ft.	kg/m
20026069	1/2	12.7	0.91	23.1	300	2.07	0.27	0.40
20026071	3/4	19.1	1.18	30.0	300	2.07	0.40	0.60
20026078	1	25.4	1.50	38.1	275	1.90	0.60	0.89

Sani-Wash™ 300



Product Specifications

Application

An economical hose for hot water washdown up to 205°F (96°C) cleanup in food processing plants, dairies, packing houses, bottling plants, breweries, canneries and creameries.

Construction Tube

EPDM synthetic rubber

Cover

White EPDM synthetic rubber

Reinforcement

Textile reinforced

Temperature Range

-40°F to 205°F (-40°C to 96°C)

Packaging

1/2"-3/4" - 500' reels, maximum 3 pieces, 50' increments
 1" - 450' reels, maximum 3 pieces, 50' increments

Branding

Example: Continental ContiTech Sani-Wash™ 300 psi WP 3/4" (19.1mm). Made in U.S.A.

Couplings

Contact fitting manufacturer for proper fitting recommendations and coupling procedure

Order Codes

569-020

Sani-Wash™ 300

SAP #	ID		Nom. OD		Max. WP		Weight	
	in.	mm	in.	mm	psi	MPa	lb./ft.	kg/m
20070992	1/2	12.7	0.84	21.3	300	2.07	0.26	0.39
20136571	5/8	15.9	1.00	25.4	300	2.07	0.31	0.46
20070993	3/4	19.1	1.17	29.7	300	2.07	0.42	0.63
20070994	1	25.4	1.47	37.3	300	2.07	0.62	0.92

Air & Multipurpose
 General Purpose
 Heavy Duty
 Push-on

Chemical Transfer

Cleaning Equipment

Food Transfer Washdown

Marine

Material Handling
 Abrasives
 Bulk Transfer
 Cement & Concrete

Mining

Petroleum
 Aircraft Fueling
 Dispensing
 Dock
 Transfer

Spray

Steam

Vacuum

LPG Delivery

Water
 Discharge
 Suction & Discharge
 Washdown

Welding

Coupling Systems

Equipment

Appendix

Super Sani-Wash™ 300



Air & Multipurpose

- General Purpose
- Heavy Duty
- Push-on

Chemical Transfer

Cleaning Equipment

Food

- Transfer
- Washdown

Marine

Material Handling

- Abrasives
- Bulk Transfer
- Cement & Concrete

Mining

Petroleum

- Aircraft Fueling
- Dispensing
- Dock Transfer

Spray

Steam

Vacuum

LPG Delivery

Water

- Discharge
- Suction & Discharge
- Washdown

Welding

Coupling Systems

Equipment

Appendix

Product Specifications

Application

An economical hose for hot water washdown up to 200°F (93°C) cleanup in food processing plants, dairies, packing houses, bottling plants, breweries, canneries and creameries. The cover of the Super Sani-Wash™ Washdown hose incorporates Microban's® antimicrobial built-in product protection.

Construction Tube

EPDM synthetic rubber

Cover

White EPDM synthetic rubber with Microban® product protection

Reinforcement

Spiral textile reinforced

Temperature Range

-40°F to 200°F (- 40°C to 93°C)

Packaging

Reels

Branding

Example: Continental ContiTech Super Sani-Wash™ 300 with Microban® antimicrobial product protection 300 psi WP. 3/4" (19.1mm). Made in U.S.A.

Couplings

Contact fitting manufacturer for proper fitting recommendation and coupling procedure.

Non-Stock/Sizes

For special production run minimum requirements, see Appendix C.

Order Codes

569-021

Super Sani-Wash™ 300

SAP #	ID		Nom. OD		Max. WP		Weight	
	White	in.	mm	in.	mm	psi	MPa	lb./ft.
20449743	1/2	12.7	0.84	21.3	300	2.07	0.26	0.39
20448570	3/4	19.1	1.17	29.7	300	2.07	0.42	0.63
20449746	1	25.4	1.47	37.3	300	2.07	0.62	0.92

*Microban® antimicrobial product protection inhibits the growth of bacteria, mold and fungi that can cause odor, stains or degradation of the hose cover. Microban® is intended to protect the hose cover only. It is not a substitute for good sanitary practice.

Marine



Air & Multipurpose

- General Purpose
- Heavy Duty
- Push-on

Chemical Transfer

Cleaning Equipment

Food

- Transfer
- Washdown

Marine

Material Handling

- Abrasives
- Bulk Transfer
- Cement & Concrete

Mining

Petroleum

- Aircraft Fueling
- Dispensing
- Dock
- Transfer

Spray

Steam

Vacuum

LPG Delivery

Water

- Discharge
- Suction & Discharge
- Washdown

Welding

Coupling Systems

Equipment

Appendix

	Page	SAE	USCG	Hardwall	Softwall
Flexshield™ Marine Barrier Hose USCG/SAE J1527 & ISO 7840 Type A1-15	108	Yes	Yes		
Marine Fuel Feed Vent Hose USCG/SAE J1527 Type A2	109	Yes	Yes		
Marine Fuel Feed Vent Hose USCG/SAE J1527 Type B2	110	Yes	Yes		
Marine Fuel Line USCG/SAE J1527 & ISO 7840 Type A1	107	Yes	Yes		
Plicord® Hardwall Wet Exhaust	103-104		Yes	Yes	
Plicord® SAE J1527 Type A2 (fuel fill)	102	Yes	Yes	Yes	
Plicord® Softwall Wet Exhaust	105-106		Yes		Yes

Plicord® SAE J1527 Type A2 Fuel Fill



Product Specifications

Application

The Plicord® SAE J1527 Type A2, ISO 7840 and CE Fuel Fill hose is for marine gasoline tanks. It is the connection from the boat's fuel fill port down to the boat's fuel tank.

Construction Tube

Nitrile synthetic rubber RMA Class A (High Oil Resistance)

Cover

Chemivic™ synthetic rubber (wrapped impression)

Reinforcement

Spiral-plied synthetic fabric with wire helix

Temperature Range

-20°F to 180°F (-29°C to 82°C)

Packaging

50' exact length, coiled, and polywrapped

Branding

Example: Continental ContiTech SAE J1527, USCG Type A2, ISO 7840

Couplings

Contact fitting manufacturer for proper fitting recommendation and coupling procedure.

Order Codes

543-414

Plicord® SAE J1527 Type A2

SAP #	ID		Nom. OD		Max. WP		Vacuum HG		Weight	
	in.	mm	in.	mm	psi	MPa	in.	mm	lb./ft.	kg/m
20050850	1¼	31.8	1.70	43.2	100	0.69	29	737	0.68	1.01
20017852	1½	38.0	1.86	47.1	100	0.69	29	737	0.65	0.97
20017855	1¾	47.6	2.30	58.4	100	0.69	29	737	0.96	1.43
20095640	2	50.8	2.43	61.7	50	0.34	29	737	1.01	1.50
20017857	2¾	69.9	2.80	71.1	50	0.34	29	737	1.19	1.77

Air & Multipurpose

General Purpose
Heavy Duty
Push-on

Chemical Transfer

Cleaning Equipment

Food

Transfer
Washdown

Marine

Material Handling

Abrasives
Bulk Transfer
Cement & Concrete

Mining

Petroleum

Aircraft Fueling
Dispensing
Dock
Transfer

Spray

Steam

Vacuum

LPG Delivery

Water

Discharge
Suction & Discharge
Washdown

Welding

Coupling Systems

Equipment

Appendix

Plicord® Hardwall Wet Exhaust

Air & Multipurpose

General Purpose
Heavy Duty
Push-on

Chemical Transfer

Cleaning Equipment

Food
Transfer
Washdown

Marine

Material Handling
Abrasives
Bulk Transfer
Cement & Concrete

Mining

Petroleum
Aircraft Fueling
Dispensing
Dock
Transfer

Spray

Steam

Vacuum

LPG Delivery

Water
Discharge
Suction & Discharge
Washdown

Welding

Coupling Systems

Equipment

Appendix



Product Specifications

Application

For water suction and discharge applications including: engine intake, bilge exhaust, toilet, holding tank and scupper lines. Also for industrial water suction and discharge applications where unique sizes are required to fit over pipe. Does not meet SAE J2006 R2 Spec.*

Construction Tube

Black Nitrile synthetic rubber RMA Class A (High Oil Resistance)

Cover

Black SBR synthetic rubber (wrapped impression)

Reinforcement

Spiral-plyed synthetic fabric with wire helix

Temperature Range

-20°F to 180°F (-29°C to 82°C)

*Spec 542-812 (<6") and 541-812 (>6") meet the SAE J2006 R2 Spec but the tube is non-oil resistant (Class C Oil Resistance)

Packaging

1/2"-5 1/2" - 50' exact length, coiled and polywrapped
6"-8" - 25' exact length, polywrapped

Branding (Spiral)

Example: Industrial ORS/Wet Exhaust Continental ContiTech

Couplings

Contact fitting manufacturer for proper fitting recommendation and coupling procedure.

Order Codes

543-193 (<6")
541-193 (>6")

Plicord® Hardwall Wet Exhaust

SAP #	ID	Nom. OD		Max. WP		Bend Radius		Vacuum HG		Weight		
		in.	mm	in.	mm	in.	mm	in.	mm	lb./ft.	kg/m	
20142763	1/2	12.7	0.95	24.3	250	1.72	2	51	29	737	0.35	0.52
20149571	5/8	15.9	1.07	27.3	200	1.38	2	51	29	737	0.40	0.59
20133706	3/4	19.0	1.19	30.4	200	1.38	3	76	29	737	0.46	0.68
20142765	7/8	22.2	1.32	33.5	200	1.38	3	76	29	737	0.52	0.77
20129126	1	25.4	1.44	36.6	150	1.03	3	76	29	737	0.57	0.84
20138386	1 1/8	28.6	1.58	40.3	150	1.03	4	102	29	737	0.64	0.95
20107682	1 1/4	31.8	1.70	43.3	150	1.03	4	102	29	737	0.70	1.04
20123332	1 3/8	34.9	1.82	46.3	125	0.86	4	102	29	737	0.75	1.11
20123383	1 1/2	38.1	1.94	49.3	100	0.69	4	102	29	737	0.81	1.20
20142751	1 5/8	41.3	2.07	52.8	100	0.69	4	102	29	737	0.87	1.29
20123333	1 3/4	44.4	2.22	56.4	100	0.69	4	102	29	737	0.94	1.40
20105482	1 7/8	47.6	2.33	59.3	100	0.69	6	152	29	737	0.99	1.47
20123384	2	50.8	2.44	62.4	75	0.52	6	152	29	737	1.05	1.56
20107683	2 1/8	54.0	2.59	65.8	75	0.52	6	152	29	737	1.11	1.65
20138387	2 1/4	57.1	2.70	68.6	75	0.52	6	152	29	737	1.16	1.72
20140304	2 3/8	60.3	2.83	72.1	75	0.52	8	203	29	737	1.22	1.81
20107684	2 1/2	63.5	3.02	76.8	75	0.52	8	203	29	737	1.57	2.33
20135126	2 3/4	69.8	3.28	83.3	50	0.34	8	203	29	737	1.72	2.56
20139655	2 7/8	73.0	3.40	86.5	50	0.34	8	203	29	737	1.79	2.66
20123334	3	76.2	3.51	89.1	50	0.34	10	254	29	737	1.77	2.63
20107686	3 1/8	79.4	3.66	93.0	50	0.34	10	254	29	737	1.86	2.77
20135127	3 1/2	88.9	4.05	103.0	50	0.34	10	254	29	737	2.07	3.08
20142764	4	101.6	4.53	115.2	50	0.34	12	305	29	737	2.45	3.65
20278423	4 1/2	114.3	5.10	129.7	30	0.21	14	356	29	737	3.47	5.17
20274816	5	127.0	5.61	142.5	30	0.21	24	610	29	737	3.83	5.70
20183338	6	152.4	6.67	169.4	30	0.21	30	762	29	737	5.19	7.73
20344004	6 5/8	168.3	7.49	190.4	30	0.21	36	914	29	737	7.93	11.80
20183339	8	203.2	8.87	225.4	30	0.21	44	1118	29	737	8.92	13.20

- Air & Multipurpose
 - General Purpose
 - Heavy Duty
 - Push-on
- Chemical Transfer
- Cleaning Equipment
- Food
 - Transfer
 - Washdown
- Marine
- Material Handling
 - Abrasives
 - Bulk Transfer
 - Cement & Concrete
- Mining
- Petroleum
 - Aircraft Fueling
 - Dispensing
 - Dock
 - Transfer
- Spray
- Steam
- Vacuum
- LPG Delivery
- Water
 - Discharge
 - Suction & Discharge
 - Washdown
- Welding
- Coupling Systems
- Equipment
- Appendix

Plicord® Softwall Wet Exhaust

Air & Multipurpose

General Purpose
Heavy Duty
Push-on

Chemical Transfer

Cleaning Equipment

Food
Transfer
Washdown

Marine

Material Handling
Abrasives
Bulk Transfer
Cement & Concrete

Mining

Petroleum
Aircraft Fueling
Dispensing
Dock
Transfer

Spray

Steam

Vacuum

LPG Delivery

Water
Discharge
Suction & Discharge
Washdown

Welding

Coupling Systems

Equipment

Appendix



Product Specifications

Application

For water discharge applications for engines, toilets, scuppers and bilge pumps. Will not part. Does not meet SAE J2006 R1 Spec.*

Construction Tube

Black Nitrile synthetic rubber RMA Class A (High Oil Resistance)

Cover

Black Chemivic™ synthetic rubber (wrapped impression)

Reinforcement

Spiral-plyed synthetic fabric

Temperature Range

-20°F to 180°F (-29°C to 82°C)

*Spec 542-813 (<6") and 541-813 (>6") meet the SAE J2006 R1 Spec but the tube is non-oil resistant (Class C Oil Resistance)

Packaging

25' exact lengths, coiled and polywrapped

Branding (Spiral)

Example: Industrial ORS/Wet Exhaust Continental ContiTech

Couplings

Contact fitting manufacturer for proper fitting recommendation and coupling procedure.

Order Codes

543-154 (<6")

541-154 (>6")

Plicord® Softwall Wet Exhaust

SAP #	ID		Nom. OD		Max. WP		Weight	
	in.	mm	in.	mm	psi	MPa	lb./ft.	kg/m
20123258	1/2	12.7	0.94	23.9	250	1.72	0.29	0.43
20126043	3/4	19.0	1.18	30.0	200	1.38	0.26	0.38
20115943	7/8	22.2	1.30	33.2	200	1.38	0.44	0.65
20107027	1	25.4	1.43	36.3	150	1.03	0.48	0.71
20156178	1 1/8	28.6	1.57	39.9	150	1.03	0.54	0.80
20113717	1 1/4	31.8	1.69	43.0	150	1.03	0.59	0.87
20107028	1 5/16	33.3	1.75	44.5	125	0.86	0.64	0.90
20110836	1 3/8	34.9	1.81	46.0	125	0.86	0.64	0.95
20107029	1 1/2	38.1	1.92	49.0	100	0.62	0.62	0.92
20107050	1 5/8	41.3	2.06	52.5	100	0.69	0.74	1.10
20108751	1 3/4	44.4	2.20	56.0	100	0.69	0.80	1.19
20115942	1 7/8	47.6	2.32	59.0	100	0.69	0.84	1.25
20107025	2	50.8	2.51	63.7	75	0.52	1.04	1.54
20137213	2 1/8	54.0	2.64	67.1	75	0.52	1.10	1.63
20105483	2 1/4	57.1	2.75	69.9	75	0.52	1.15	1.71
20105484	2 3/8	60.3	2.94	74.7	75	0.52	1.35	2.01
20107080	2 1/2	63.5	3.05	77.6	75	0.52	1.41	2.10
20107081	2 7/8	73.0	3.44	87.4	75	0.52	1.61	2.31
20105485	3	76.2	3.54	90.1	50	0.34	1.66	2.47
20137215	3 1/8	79.4	3.70	94.0	50	0.34	1.74	2.59
20107082	3 1/2	88.9	4.09	109.0	50	0.34	1.94	2.89
20110837	4	101.6	4.57	116.1	50	0.34	2.18	3.24
20110838	4 1/2	114.3	5.06	128.6	30	0.21	2.43	3.62
20118697	5	127.0	5.56	141.3	30	0.21	2.68	3.99
20137217	5 1/2	139.7	6.09	154.8	30	0.21	2.94	4.38
20114451	6	152.4	6.56	166.6	30	0.21	3.19	4.75
20126042	6 5/8	168.3	7.37	187.3	30	0.21	4.78	7.12

- Air & Multipurpose
 - General Purpose
 - Heavy Duty
 - Push-on
- Chemical Transfer
- Cleaning Equipment
- Food
 - Transfer
 - Washdown
- Marine
- Material Handling
 - Abrasives
 - Bulk Transfer
 - Cement & Concrete
- Mining
- Petroleum
 - Aircraft Fueling
 - Dispensing
 - Dock
 - Transfer
- Spray
- Steam
- Vacuum
- LPG Delivery
- Water
 - Discharge
 - Suction & Discharge
 - Washdown
- Welding
- Coupling Systems
- Equipment
- Appendix

Marine Fuel Line USCG/SAE J1527 & ISO 7840 Type A1

Air & Multipurpose

General Purpose
Heavy Duty
Push-on

Chemical Transfer

Cleaning Equipment

Food
Transfer
Washdown

Marine

Material Handling
Abrasives
Bulk Transfer
Cement & Concrete

Mining

Petroleum
Aircraft Fueling
Dispensing
Dock
Transfer

Spray

Steam

Vacuum

LPG Delivery

Water
Discharge
Suction & Discharge
Washdown

Welding

Coupling Systems

Equipment

Appendix



Product Specifications

Application

For marine gasoline tanks. For fuel feed and vent applications on marine pleasure craft. It meets U.S. Coast Guard and International Marine Certification Institute requirements for type A1 service.

Construction Tube

Black Nitrile synthetic rubber RMA Class A (High Oil Resistance)

Cover

Black Chemivic™ synthetic rubber

Reinforcement

Spiral synthetic yarn

Temperature Range

0°F to 115°F (-17°C to 46°C)

Packaging

200' reels, maximum 3 pieces, increments of 50'

Branding

Example: Continental ContiTech USCG/SAE J 1527 Type A1 ISO 7840-A1 CE

Couplings

Contact fitting manufacturer for proper fitting recommendation and coupling procedure.

Order Codes

595-032

Marine Fuel Line SAE J1527 Type A1

SAP #	ID		Nom. OD		Max. WP		Weight	
	in.	mm	in.	mm	psi	MPa	lb./ft.	kg/m
20069186	1/4	6.4	0.65	16.5	49	0.34	0.17	0.25
20069187	5/16	7.9	0.71	18.0	49	0.34	0.19	0.28
20069188	3/8	9.5	0.78	19.8	49	0.34	0.20	0.30
20028994	1/2	12.7	0.89	23.0	36	0.25	0.26	0.39
20106800	5/8	15.9	1.06	25.8	36	0.25	0.35	0.52

Flexshield™ SAE J1527 USCG Type A1-15 / ISO 7840 Marine Barrier Hose



Product Specifications

Application

Designed for marine gasoline tanks for fuel feed and vent applications on marine pleasure craft. Barrier style construction meets new EPA requirements for low permeation class A1-15 marine fuel lines. Fire resistant cover provides minimum 2½ minute fire resistivity for USCG type A service.

Construction Tube

Black Chemivic™ synthetic rubber

Cover

Nitrile synthetic rubber

Reinforcement

Polyester spiral with nylon barrier

Temperature Range

-20°F to 180°F (-29°C to 82°C)

Packaging

Reels

Branding

Example: Flexshield™ 5412 3/8" SAE J1527 USCG Type A1-15 / ISO 7840-A1 CE Continental ContiTech

Couplings

Contact fitting manufacturer for proper fitting recommendation and coupling procedure.

Non-Stock/Sizes

Contact a Continental ContiTech representative for special production run minimum requirements and private label options.

Order Codes

1/4" - 475-412-008
 5/16" - 475-412-010
 3/8" - 475-412-012
 1/2" - 475-412-016

Flexshield™ SAE J1527 Type A1-15

SAP #	ID		Nom. OD		Weight		Min. Burst	
	in.	mm	in.	mm	lb./ft.	kg/m	psi	bar
20464766	1/4	5.95	0.627	15.92	0.15	0.23	250	17.2
20464768	5/16	7.54	0.658	16.71	0.16	0.24	250	17.2
20464769	3/8	9.12	0.725	18.41	0.20	0.30	250	17.2

Air & Multipurpose
 General Purpose
 Heavy Duty
 Push-on

Chemical Transfer

Cleaning Equipment

Food
 Transfer
 Washdown

Marine

Material Handling
 Abrasives
 Bulk Transfer
 Cement & Concrete

Mining

Petroleum
 Aircraft Fueling
 Dispensing
 Dock
 Transfer

Spray

Steam

Vacuum

LPG Delivery

Water
 Discharge
 Suction & Discharge
 Washdown

Welding

Coupling Systems

Equipment

Appendix

Marine Fuel Feed Vent Hose USCG/ SAE J1527 Type A2 Fire Retardant



Air & Multipurpose
General Purpose
Heavy Duty
Push-on

Chemical Transfer

Cleaning Equipment

Food
Transfer
Washdown

Marine

Material Handling
Abrasives
Bulk Transfer
Cement & Concrete

Mining

Petroleum
Aircraft Fueling
Dispensing
Dock
Transfer

Spray

Steam

Vacuum

LPG Delivery

Water
Discharge
Suction & Discharge
Washdown

Welding

Coupling Systems

Equipment

Appendix

Product Specifications

Application

For fuel feed and vent application on marine pleasure craft.

Construction Tube

Black Nitrile synthetic rubber RMA Class A (High Oil Resistance)

Cover

Gray Chemivic™ synthetic rubber

Reinforcement

Spiral synthetic yarn

Temperature Range

0°F to 115°F (-18°C to 46°C)

Packaging

500'-750' reels, maximum 3 pieces, minimum length 35'

Branding (Spiral)

Example: Continental ContiTech USCG/SAE J 1527 Type A2

Couplings

Contact fitting manufacturer for proper fitting recommendation and coupling procedure.

Order Codes

595-022

Marine Fuel Feed Vent Hose Type A2

ID	Nom. OD		Max. WP		Weight		
	in.	mm	in.	mm	lb./ft.	kg/m	
1/4	6.4	0.66	16.8	35	0.24	0.19	0.28
5/16	7.9	0.72	18.3	35	0.24	0.22	0.33
3/8	9.5	0.78	19.8	35	0.24	0.24	0.36
1/2	12.7	0.91	23.1	35	0.24	0.3	0.45
5/8	15.9	0.96	25.8	35	0.24	0.34	0.51

Marine Fuel Feed Vent Hose USCG/SAE J1527 Type B2 Non-Fire Retardant



Product Specifications

Application

For fuel feed and vent application on marine pleasure craft.

Construction Tube

Nitrile synthetic rubber RMA Class A (High Oil Resistance)

Cover

Gray Chemivic™ synthetic rubber

Reinforcement

Spiral synthetic yarn

Temperature Range

0°F to 115°F (-18°C to 46°C)

Packaging

500'-750'; maximum 3 pieces, minimum length 35'

Branding

Example: Continental ContiTech USCG/SAE J 1527 Type B2.

Couplings

Contact fitting manufacturer for proper fitting recommendation and coupling procedure.

Order Codes

595-009

Marine Fuel Feed Vent Hose Type B2

SAP #	ID		Nom. OD		Max. WP		Weight	
	in.	mm	in.	mm	psi	MPa	lb./ft.	kg/m
Gray	1/4	6.4	0.58	14.7	34	0.23	0.12	0.18
	5/16	7.9	0.66	16.8	34	0.23	0.15	0.22
20028805	3/8	9.5	0.70	17.8	34	0.23	0.16	0.24
	1/2	12.7	0.81	20.6	34	0.23	0.18	0.27
20028810	5/8	15.9	0.96	24.4	34	0.23	0.19	0.28

Air & Multipurpose
General Purpose
Heavy Duty
Push-on

Chemical Transfer

Cleaning Equipment

Food
Transfer
Washdown

Marine

Material Handling
Abrasives
Bulk Transfer
Cement & Concrete

Mining

Petroleum
Aircraft Fueling
Dispensing
Dock
Transfer

Spray

Steam

Vacuum

LPG Delivery

Water
Discharge
Suction & Discharge
Washdown

Welding

Coupling Systems

Equipment

Appendix

Abrasives



Air & Multipurpose

- General Purpose
- Heavy Duty
- Push-on

Chemical Transfer

Cleaning Equipment

Food

- Transfer
- Washdown

Marine

Material Handling

- Abrasives
- Bulk Transfer
- Cement & Concrete

Mining

Petroleum

- Aircraft Fueling
- Dispensing
- Dock Transfer

Spray

Steam

Vacuum

LPG Delivery

Water

- Discharge
- Suction & Discharge
- Washdown

Welding

Coupling Systems

Equipment

Appendix

	Page	Food Grade	Clear	Static Dissipating/ Static Conductive	Tube	Temp. Range	Static Wire	Thermo-plastic	Rubber
Artrac	118			Yes		-40°F to 158°F (-40°C to 70°C)		Yes	
Arvac SW	117					-40°F to 158°F (-40°C to 70°C)	Yes	Yes	
Blucor	115			Yes*		-25°F to 180°F (-32°C to 82°C)			Yes
Blucor Couplings	116								
Diversiflex	119			Yes*		-25°F to 180°F (-32°C to 82°C)			Yes
Diversipipe 75	120			Yes*		-40°F to 180°F (-40°C to 82°C)			Yes
Diversipipe 150	121			Yes*		-40°F to 180°F (-40°C to 82°C)			Yes
Flexible Downspout	122					-25°F to 180°F (-32°C to 82°C)			Yes
Nutriflex Static Wire	76	Yes	Yes			-15°F to 158°F (-26°C to 70°C)	Yes	Yes	
Plicord Blast	113			Yes		-25°F to 180°F (-32°C to 82°C)			Yes
Plicord Dredge Sleeve	124			Yes		-25°F to 180°F (-32°C to 82°C)			Yes
Plicord Hydrovator	123			Yes		-25°F to 180°F (-32°C to 82°C)			Yes
Plicord RVC	125					-20°F to 180°F (-29°C to 82°C)			Yes
Plicord Sand Suction	126			Yes		-25°F to 180°F (-32°C to 82°C)			Yes
Plicord XF Blast	114			Yes		-25°F to 180°F (-32°C to 82°C)			Yes
Sandblast Deadman	112					-20°F to 190°F (-29°C to 88°C)			Yes
Spiraflex Air Seeder	127		Yes			0°F to 158°F (-18°C to 70°C)			
Spirathane HD	128					0°F to 158°F (-18°C to 70°C)		Yes	
Spirathane LD	130		Yes			0°F to 158°F (-18°C to 70°C)		Yes	
Spirathane PT	129	Yes	Yes			0°F to 158°F (-18°C to 70°C)	Yes	Yes	

Sandblast Deadman



Product Specifications

Application

Double Line Sandblast Deadman hose is for use with systems for the automatic shut-off of sandblasting equipment at the operator end of the system. Used in a pneumatic closed circuit pattern, deadman hose is connected to air-actuated shut valves which, in turn, are controlled at all times by the sandblast operator via a "deadman" switch at the nozzle end of the sandblast hose.

Construction Tube

Premium-quality EPDM synthetic rubber, RMA Class C (Limited Oil Resistance)

Cover

Yellow/Yellow EPDM, RMA Class C (Limited Oil Resistance)

Reinforcement

Spiral-plied synthetic yarn

Temperature Range

-20°F to 190°F (-29°C to 88°C)

Packaging

450'-750' reels, maximum 2 pieces, minimum length 25'

Branding

Continuous brand 3/16" ID (4.8mm) Sandblast Deadman. Made in U.S.A. Continental ContiTech

Couplings

Contact fitting manufacturer for proper fitting recommendation and coupling procedure.

Order Codes

- 569-595 Yellow/Yellow
- 569-616 Red/Blue
- 569-676 Red/Black
- 569-696 Yellow/Gray
- 569-628 Blue/Blue

Sandblast Deadman

SAP #		ID			Nom. OD		Max. WP		Weight			
Yellow/ Yellow	Black/ Yellow	Red/Black	Yellow/ Gray	Blue/Blue	in.	mm	in.	mm	psi	MPa	lb./ft.	kg/m
20027303	20266436	20709610	20646905	20658279	3/16	4.8	0.44	11.2	200	1.38	0.14	0.21

Air & Multipurpose

General Purpose
Heavy Duty
Push-on

Chemical Transfer

Cleaning Equipment

Food

Transfer
Washdown

Marine

Material Handling

Abrasives
Bulk Transfer
Cement & Concrete

Mining

Petroleum

Aircraft Fueling
Dispensing
Dock
Transfer

Spray

Steam

Vacuum

LPG Delivery

Water

Discharge
Suction & Discharge
Washdown

Welding

Coupling Systems

Equipment

Appendix

Plicord® Blast



Air & Multipurpose

- General Purpose
- Heavy Duty
- Push-on

Chemical Transfer

Cleaning Equipment

- Food**
- Transfer
- Washdown

Marine

- Material Handling**
- Abrasives
- Bulk Transfer
- Cement & Concrete

Mining

- Petroleum**
- Aircraft Fueling
- Dispensing
- Dock
- Transfer

Spray

Steam

Vacuum

LPG Delivery

- Water**
- Discharge
- Suction & Discharge
- Washdown

Welding

Coupling Systems

Equipment

Appendix

Product Specifications

Application

Heavy-duty hose for steel shot or sand blasting in cleaning or finishing metal, stone, glass or other surfaces.

Construction Tube

ChemiTuf® synthetic rubber (static dissipating/static conductive)

Cover

2 ply: Black SBR synthetic rubber (wrapped impression)
4 ply: Green SBR synthetic rubber (wrapped impression)

Reinforcement

Spiral-plied synthetic fabric

Temperature Range

-25°F to 180°F (-32°C to 82°C)

Packaging

50' lengths, coiled and polywrapped

Branding (Spiral)

Example: Continental ContiTech Plicord® Blast 150 psi WP

Couplings

Contact fitting manufacturer for proper fitting recommendation and coupling procedure.

Plicord® Blast (2 Ply)

Order Codes: 549-020, Survivor 549-805

SAP #		ID		Nom. OD		Max. WP		Weight	
Black	Survivor Compound	in.	mm	in.	mm	psi	MPa	lb./ft.	kg/m
20018947	20673581	1/2	12.7	1.13	28.7	150	1.03	0.41	0.61
20018954	20678582	3/4	19.1	1.48	37.6	150	1.03	0.68	1.01
20018963	20673583	1	25.4	1.88	47.8	150	1.03	1.05	1.56
20018972	20678584	1¼	31.8	2.16	54.9	150	1.03	1.26	1.88
20018982	20673585	1½	38.1	2.38	60.5	150	1.03	1.42	2.11
20018993	20677610	2	50.8	2.86	72.6	150	1.03	1.70	2.53

Plicord® Blast (4 Ply)

Order Codes: 549-027

SAP #	ID		Nom. OD		Max. WP		Weight	
Green	in.	mm	in.	mm	psi	MPa	lb./ft.	kg/m
20031672	1/2	12.7	1.14	26.7	150	1.03	0.44	0.61
20019031	3/4	19.1	1.50	38.1	150	1.03	0.71	1.06
20019033	1	25.4	1.88	47.8	150	1.03	1.08	1.61
20019037	1¼	31.8	2.16	54.9	150	1.03	1.31	1.95
20019040	1½	38.1	2.38	60.5	150	1.03	1.45	2.16
20019043	2	50.8	2.88	73.2	150	1.03	1.75	2.60

Plicord® XF Blast



Product Specifications

Application

Standard-duty hose for steel shot or sand blasting in cleaning or finishing metal, stone, glass or other surfaces.

Construction Tube

ChemiTuf® synthetic rubber (static dissipating/static conductive)

Cover

Black SBR synthetic rubber (static dissipating/static conductive) (wrapped impression)

Reinforcement

Spiral-plyed synthetic fabric

Temperature Range

-25°F to 180°F (-32°C to 82°C)

Packaging

50' lengths, coiled and polywrapped

Branding (Spiral)

Example: Continental ContiTech Plicord® XF Blast 150 psi WP

Couplings

Contact fitting manufacturer for proper fitting recommendation and coupling procedure.

Plicord® XF Blast (2 Ply)

Order Codes: 549-018

SAP #	ID		Nom. OD		Max. WP		Weight	
	in.	mm	in.	mm	psi	MPa	lb./ft.	kg/m
20018907	5/8	15.9	1.13	28.7	150	1.03	0.37	0.55
20018911	7/8	22.2	1.51	38.4	150	1.03	0.61	0.91
20018913	1 1/8	28.6	1.88	47.8	150	1.03	0.92	1.37
20018916	1 3/8	34.9	2.15	54.6	150	1.03	1.12	1.67
20018920	1 5/8	41.3	2.38	60.5	150	1.03	1.21	1.80
20018924	2 1/8	54.0	2.89	73.4	150	1.03	1.53	2.28

Plicord® XF Blast (4 Ply)

Order Codes: 549-019

SAP #	ID		Nom. OD		Max. WP		Weight	
	in.	mm	in.	mm	psi	MPa	lb./ft.	kg/m
20018925	5/8	15.9	1.12	28.5	150	1.03	0.35	0.52
20018927	7/8	22.2	1.50	38.1	150	1.03	0.71	1.06
20018929	1 1/8	28.6	1.88	47.8	150	1.03	0.93	1.38
20018933	1 3/8	34.9	2.16	54.9	150	1.03	1.11	1.65
20018938	1 5/8	41.3	2.38	60.5	150	1.03	1.23	1.83
20018943	2 1/8	54.0	2.88	73.2	150	1.03	1.48	2.20

Air & Multipurpose

General Purpose
Heavy Duty
Push-on

Chemical Transfer

Cleaning Equipment

Food

Transfer
Washdown

Marine

Material Handling

Abrasives
Bulk Transfer
Cement & Concrete

Mining

Petroleum

Aircraft Fueling
Dispensing
Dock
Transfer

Spray

Steam

Vacuum

LPG Delivery

Water

Discharge
Suction & Discharge
Washdown

Welding

Coupling Systems

Equipment

Appendix

Blucor™



Air & Multipurpose
 General Purpose
 Heavy Duty
 Push-on

Chemical Transfer

Cleaning Equipment

Food
 Transfer
 Washdown

Marine

Material Handling
 Abrasives
 Bulk Transfer
 Cement & Concrete

Mining

Petroleum
 Aircraft Fueling
 Dispensing
 Dock
 Transfer

Spray

Steam

Vacuum

LPG Delivery

Water
 Discharge
 Suction & Discharge
 Washdown

Welding

Coupling Systems

Equipment

Appendix

Product Specifications

Application

Blucor™ material handling hose with the Continental ContiTech 150 psi bolt-on split flange coupling is an easy and economical choice. Blucor™ has the high strength needed to handle pressure or suction service in the transfer of dry bulk, slurry, salt, cement, fertilizers and a limited quantity of oil-based products.

Construction Tube

3/8" Black Pureten™, 3/8" Black ChemiTuf® (static dissipating/static conductive), or 3/8" Tan Pureten™

Cover

Black corrugated abrasion-resistant SBR (wrapped impression)

Reinforcement

Spiral-plyed synthetic fabric with wire helix

Temperature Range

-25°F to 180°F (-32°C to 82°C)

Packaging

3"-8" - Coiled or straight, polywrapped
 10"-16" - Straight, polywrapped

Branding (Spiral)

Example: Continental ContiTech Blucor™ Black Pureten™ Liner

Couplings

Blucor™ bolt-on split flange couplings, see next page.

Non-Stock/Sizes

Maximum shipping length: 3"-8": 100 ft.; 10", 12" & 16": 50 ft.

Order Codes

541-789 (black Pureten™)
 541-458 (tan Pureten™)
 541-788 (black ChemiTuf®)
 541-934 (Survivor)

Blucor™

SAP #		ID		Nom. OD		Max. WP		Bend Radius		Vacuum HG		Weight		
Black Pureten	Tan Pureten	Black Tufysn	W/ Survivor Compound	in.	mm	in.	mm	psi	in.	mm	in.	mm	lb./ft.	kg/m
20016075	20727995	20174317	20677611	3	76.2	4.39	111.5	150	16	406	29	737	4.63	6.89
20016084	20015583	20472262	20606370	4	101.6	5.25	133.4	150	20	508	29	737	5.67	8.44
20016105	20015584	20016070	20673534	6	152.4	7.37	187.2	150	36	914	29	737	9.48	14.11
20016127	20091843	20616942	20710232	8	203.2	9.44	239.8	150	48	1219	29	737	14.20	21.13
20016144	20015585	20099997	20548906	10	254.0	11.38	289.1	150	60	1524	29	737	16.63	24.75
20032306	20015586	20050994		12	304.8	13.81	350.8	100	72	1829	29	737	23.40	34.82

Blucor™ Couplings

Bolt-On Split Flange Couplings



Product Specifications

Specifications

Each fitting is manufactured of high-tensile 432 aluminum alloy. All flanges are 150 lbs. ANSI B16.5. Bolt-on split flange couplings are supplied with necessary mounting hardware (bolts, nuts and washers). Internal configurations of fitting corrugations have been designed specifically to match the corrugation of the Blucor™ hose.

Order Codes

604-189

Blucor™ Couplings

SAP #	ID		Nom. OD		Weight	
	in.	mm	in.	mm	lb./ft.	kg/m
20021516	3	76.2	7.5	190.5	3.6	5.36
20021517	4	101.6	9.0	228.6	4.0	5.95
20021518	6	152.4	11.0	279.4	8.2	12.20
20021519	8	203.2	13.5	342.9	14.0	20.83
20021520	10	254.0	16.0	406.4	25.0	37.20
20021521	12	304.8	19.0	482.6	30.0	44.64

Air & Multipurpose
 General Purpose
 Heavy Duty
 Push-on

Chemical Transfer

Cleaning Equipment

Food
 Transfer
 Washdown

Marine

Material Handling
 Abrasives
 Bulk Transfer
 Cement & Concrete

Mining

Petroleum
 Aircraft Fueling
 Dispensing
 Dock
 Transfer

Spray

Steam

Vacuum

LPG Delivery

Water
 Discharge
 Suction & Discharge
 Washdown

Welding

Coupling Systems

Equipment

Appendix

Arvac™ SW



Product Specifications

Air & Multipurpose

- General Purpose
- Heavy Duty
- Push-on

Chemical Transfer

Cleaning Equipment

Food

- Transfer
- Washdown

Marine

Material Handling

- Abrasives
- Bulk Transfer
- Cement & Concrete

Mining

Petroleum

- Aircraft Fueling
- Dispensing
- Dock Transfer

Spray

Steam

Vacuum

LPG Delivery

Water

- Discharge
- Suction & Discharge
- Washdown

Welding

Coupling Systems

Equipment

Appendix

Application

Heavy-duty abrasion-resistant suction hose used for a variety of abrasive material-handling applications, including the transfer of sand, gravel, cement, fly ash, glass, metals, plastic pellets, fertilizers, rock salts and slurries. Static wire for static dissipation.

Construction Tube

Higher-temperature urethane

Cover

Static-dissipating thermoplastic alloyed blend of nitrile, polyurethane and PVC

Reinforcement

Rigid high-density PVC helix

Temperature Range

-40°F to 158°F (-40°C to 70°C)

Packaging

- 1¼"-6" - 20' lengths, polytube
- 100' lengths, coiled and polywrapped
- 8"-10" - 20', 40', 50' lengths, polytube

Branding

Not branded

Couplings

Contact fitting manufacturer for proper fitting recommendation and coupling procedure.

Non-Stock/Sizes

Contact Continental ContiTech for special production run minimum requirements.

Order Codes

586-550

Arvac™ SW

SAP #	ID	Nom. OD		Max. WP		Weight		Vacuum HG		Bend Radius		Length	
		in.	mm	psi	MPa	lb./ft.	kg/m	in.	mm	in.	mm		
20448195	1¼	31.8	1.60	40.7	45	0.31	0.35	0.52	29	737	3.0	76	100
20448194	1½	38.1	1.87	47.4	40	0.28	0.39	0.58	29	737	3.0	76	100
20448193	2	50.8	2.46	62.5	40	0.28	0.67	0.99	29	737	2.5	63	100
20448192	2½	63.5	3.03	77.0	35	0.24	0.90	1.33	29	737	4.0	101	100
20448191	3	76.2	3.60	91.5	30	0.21	1.17	1.73	29	737	6.0	152	100
20448190	4	101.6	4.74	120.5	30	0.21	1.97	2.91	29	737	7.0	177	100
20447689	5	127.0	5.81	147.5	30	0.21	2.58	3.82	29	737	8.0	203	100
20452698	6	152.4	6.89	175.0	25	0.17	3.32	4.91	29	737	8.0	203	20
20452697	6	152.4	6.89	175.0	25	0.17	3.32	4.91	29	737	8.0	203	50
20447688	6	152.4	6.89	175.0	25	0.17	3.32	4.91	29	737	8.0	203	100
20447687	8	203.2	9.13	232.0	20	0.14	5.66	8.38	29	737	18.0	456	20
20450354	8	203.2	9.13	232.0	20	0.14	5.66	8.38	29	737	18.0	456	50
20447686	10	254.0	11.16	283.5	20	0.14	7.86	11.63	29	737	36.0	912	20
20460651	10	254.0	11.16	283.5	20	0.14	7.86	11.63	29	737	36.0	912	40

Artrac®



Product Specifications

Application

The Artrac® hose is used for a variety of abrasive, material-handling applications to transfer sand, gravel, cement, fly ash, glass, metals, plastic pellets, fertilizers, rock salts and slurries.

Construction Tube

Thermoplastic alloyed blend of polyurethane and PVC (static dissipating/static conductive)

Cover

Thermoplastic alloyed blend of nitrile, polyurethane, and PVC (non-conductive) (Available with conductive cover - see order code below.)

Reinforcement

Rigid high-density PVC helix

Temperature Range

-40°F to 158°F (-40°C to 70°C)

Packaging

1¼"-6" - 100' lengths, coiled and polywrapped
8"-10" - 20' lengths, polytube

Branding

Not branded

Couplings

Contact fitting manufacturer for proper fitting recommendation and coupling procedure.

Non-Stock/Sizes

Contact customer service

Order Codes

586-462
586-522 (with conductive cover)

Artrac® Abrasive Material Handling

SAP #	ID	Nom. OD		Max. WP		Bend Radius		Vacuum HG		Weight			
Black	w/ Conductive Cove	in.	mm	in.	mm	psi	MPa	in.	mm	in.	mm	lb./ft.	kg/m
20013527		1¼	31.8	1.63	41.4	45	0.31	3.0	76	29	737	0.34	0.51
20013528	20762598	1½	38.1	1.89	48.0	40	0.28	3.0	76	29	737	0.40	0.60
20013529	20762599	2	50.8	2.47	62.7	40	0.28	2.5	63	29	737	0.67	1.00
20013531		2½	63.5	3.05	77.5	35	0.24	4.0	101	29	737	0.87	1.29
20013532	20358269	3	76.2	3.69	93.7	30	0.21	6.0	152	29	737	1.16	1.73
20013535	20247316	4	101.6	4.81	122.2	30	0.21	7.0	177	29	737	2.16	3.21
20013539		5	127.0	5.78	146.8	30	0.21	8.0	203	29	737	2.60	3.87
20013545	20247315	6	152.4	7.08	179.8	25	0.17	8.0	203	29	737	3.43	5.10
20013552		8	203.2	9.22	234.2	20	0.14	18.0	456	29	737	5.84	8.69
20013554		10	254.0	11.21	284.7	20	0.14	36.0	912	29	737	7.96	11.85

Air & Multipurpose

General Purpose
Heavy Duty
Push-on

Chemical Transfer

Cleaning Equipment

Food
Transfer
Washdown

Marine

Material Handling
Abrasives
Bulk Transfer
Cement & Concrete

Mining

Petroleum
Aircraft Fueling
Dispensing
Dock
Transfer

Spray

Steam

Vacuum

LPG Delivery

Water
Discharge
Suction & Discharge
Washdown

Welding

Coupling Systems

Equipment

Appendix

Diversiflex™



Air & Multipurpose

- General Purpose
- Heavy Duty
- Push-on

Chemical Transfer

Cleaning Equipment

Food

- Transfer
- Washdown

Marine

Material Handling

- Abrasives
- Bulk Transfer
- Cement & Concrete

Mining

Petroleum

- Aircraft Fueling
- Dispensing
- Dock
- Transfer

Spray

Steam

Vacuum

LPG Delivery

Water

- Discharge
- Suction & Discharge
- Washdown

Welding

Coupling Systems

Equipment

Appendix

Product Specifications

Application

Provides the high strength needed to handle pressure or suction service in the movement of non-oily dry bulk materials such as salt, cement, fertilizers and dry chemicals. Typical applications include unloading hoppers to rail cars or barges and transferring materials from rail cars or barges to storage units.

Construction Tube

1/4" Black ChemiTuf® synthetic rubber for abrasion resistance (static dissipating/static conductive)

Cover

Abrasion-resistant SBR synthetic rubber (corrugated surface) (wrapped impression)

Reinforcement

Spiral-plyed synthetic fabric with wire helix

Temperature Range

-25°F to 180°F (-32°C to 82°C)

Packaging

Polywrapped

Branding

Example: Continental ContiTech Plicord® Diversiflex™ Hose 75 psi Max WP

Couplings

Contact fitting manufacturer for proper fitting recommendation and coupling procedure.

Non-Stock/Sizes

Available up to 18" ID

Order Codes

541-400

Diversiflex™

SAP #	ID	Nom. OD		Max. WP		Bend Radius		Vacuum HG		Weight		
		in.	mm	in.	mm	in.	mm	in.	mm	lb./ft.	kg/m	
20212864	4	101.6	4.88	124.0	75	0.52	20	508	29	737	3.43	5.10
20116642	5	127.0	6.25	158.5	75	0.52	25	635	29	737	6.32	9.41
20325641	6	152.4	6.92	175.8	75	0.52	36	914	29	737	5.84	8.69
20268121	6 5/8	168.3	7.60	193.0	75	0.52	40	1016	29	737	7.04	10.48
20015474	8	203.2	9.05	229.9	75	0.52	48	1219	29	737	9.22	13.72
20031577	8 5/8	219.2	9.69	246.1	75	0.52	52	1321	29	737	10.82	16.10
20316082	10	254.0	11.04	280.4	75	0.52	60	1524	29	737	12.04	17.92
20587462	12	304.8	13.16	334.3	75	0.52	72	1829	29	737	16.38	24.38
20646669	12 3/4	323.9	13.91	353.3	75	0.52	77	1956	29	737	17.78	26.46

Diversipipe® 75



Product Specifications

Application

A high-quality flexible hose for replacing cast iron pipes for the transfer of abrasive materials or corrosive chemicals where installation requires minimum bends or where the inherent flexibility of a durable rubber hose is required. Diversipipe® is also available in a softwall construction for discharge service.

Construction Tube

Black ChemiTuf® synthetic rubber (static dissipating/static conductive) for slurry and dry bulk transfer, black Pureten™ for slurry, tan Pureten™ for slurry with high kinetic energy

Cover

SBR synthetic rubber (wrapped impression)

Reinforcement

Spiral-plied synthetic fabric with wire helix

Temperature Range

-40°F to 180°F (-40°C to 82°C)

Packaging

Polywrapped

Branding

Example: Continental ContiTech Plicord® Material Handling Hose, 75 psi Max WP

Couplings

Contact fitting manufacturer for proper fitting recommendation and coupling procedure.

Non-Stock/Sizes

Available up to 18" ID

Order Codes

Black ChemiTuf®: 541-047 (1/4" tube gauge)
 541-044* (3/8" tube gauge)
 541-050* (1/2" tube gauge)
 Black Pureten™: 541-731 (1/4" tube gauge)
 Tan Pureten™: 541-335 (1/4" tube gauge)
 541-353* (3/8" tube gauge)

Diversipipe® 75

SAP #		ID	Nom. OD		Max. WP		Bend Radius		Vacuum HG		Weight			
(1/4)	(1/4)	(3/8)	in.	mm	in.	mm	psi	MPa	in.	mm	in.	mm	lb./ft.	kg/m
20469185		20609650	2	50.8	2.91	73.9	75	0.52	12	304.80	29	736.6	1.98	2.95
20258672			2½	63.5	3.39	86.1	75	0.52	15	381.00	29	736.6	2.44	3.64
20308540		20015308	3	76.2	3.89	98.8	75	0.52	18	457.20	29	736.6	2.99	4.46
20269761	20613574	20015309	4	101.6	4.91	124.7	75	0.52	24	609.60	29	736.6	3.79	5.65
20014880	20320682	20015310	4½	114.3	5.50	139.7	75	0.52	27	685.80	29	736.6	4.74	7.06
20269636			5	127.0	6.44	163.6	75	0.52	30	762.00	29	736.6	5.48	8.17
20421310	20015288	20015313	6	152.4	7.13	181.1	75	0.52	36	914.40	29	736.6	7.33	10.92
20268296	20015290		6¾	168.3	7.78	197.6	75	0.52	39.7	1009.65	29	736.6	8.36	12.46
20472389	20015291	20015315	8	203.2	9.19	233.4	75	0.52	48	1219.20	29	736.6	10.48	15.62
		20731114	8¾	219.1	9.75	247.6	75	0.52	51.75	1314.45	29	736.6	11.43	17.03
20048941			10	254.0	11.23	285.2	75	0.52	60	1524.00	29	736.6	14.83	22.10
20048942	20322091		12	304.8	13.31	338.1	75	0.52	72	1828.80	29	736.6	18.16	27.06

*Note: 3/8" and 1/2" tube gauge specs available on request. Contact Customer Service.

Air & Multipurpose
 General Purpose
 Heavy Duty
 Push-on

Chemical Transfer

Cleaning Equipment

Food
 Transfer
 Washdown

Marine

Material Handling
 Abrasives
 Bulk Transfer
 Cement & Concrete

Mining

Petroleum
 Aircraft Fueling
 Dispensing
 Dock
 Transfer

Spray

Steam

Vacuum

LPG Delivery

Water
 Discharge
 Suction & Discharge
 Washdown

Welding

Coupling Systems

Equipment

Appendix

Diversipipe® 150



Air & Multipurpose

- General Purpose
- Heavy Duty
- Push-on

Chemical Transfer

Cleaning Equipment

Food

- Transfer
- Washdown

Marine

Material Handling

- Abrasives
- Bulk Transfer
- Cement & Concrete

Mining

Petroleum

- Aircraft Fueling
- Dispensing
- Dock
- Transfer

Spray

Steam

Vacuum

LPG Delivery

Water

- Discharge
- Suction & Discharge
- Washdown

Welding

Coupling Systems

Equipment

Appendix

Product Specifications

Application

A high-quality flexible hose for replacing cast iron pipes for the transfer of abrasive materials or corrosive chemicals where installation requires minimum bends or where the inherent flexibility of a durable rubber hose is required. Diversipipe® is also available in a softwall construction for a discharge service.

Construction Tube

Black ChemiTuf® (static dissipating/static conductive) for slurry and dry bulk transfer, black Pureten™ for slurry, tan Pureten™ for slurry with high kinetic energy

Cover

SBR synthetic rubber (wrapped impression)

Reinforcement

Spiral-plied synthetic fabric with wire helix

Temperature Range

-40°F to 180°F (-40°C to 82°C)

Packaging

Polywrapped

Branding

Example: Continental ContiTech Plicord® Material Handling Hose, 150 psi Max WP

Couplings

Contact fitting manufacturer for proper fitting recommendation and coupling procedure.

Non-Stock/Sizes

Available up to 18" ID

Order Codes

- Black ChemiTuf®: 541-362 (1/4" tube gauge)
- 541-364* (3/8" tube gauge)
- 541-360* (1/2" tube gauge)
- Black Pureten™: 541-372 (1/4" tube gauge)
- 541-350* (3/8" tube gauge)
- 541-369* (1/2" tube gauge)
- Tan Pureten™: 541-380 (1/4" tube gauge)
- 541-366* (3/8" tube gauge)
- 541-373* (1/2" tube gauge)

Diversipipe® 150

SAP #	ID	Nom. OD		Max. WP		Bend Radius		Vacuum HG		Weight		
(1/4)	in.	mm	in.	mm	psi	MPa	in.	mm	in.	mm	lb./ft.	kg/m
20046633	2	50.8	2.97	75.4	150	1.03	12	304.80	29	736.6	2.11	3.14
20221923	2½	63.5	3.44	87.4	150	1.03	15	381.00	29	736.6	2.65	3.95
20208953	3	76.2	3.94	100.1	150	1.03	18	457.20	29	736.6	3.05	4.54
20269765	4	101.6	5.00	127.0	150	1.03	24	609.60	29	736.6	4.10	6.11
20313031	4½	114.3	5.53	140.5	150	1.03	27	685.80	29	736.6	4.91	7.32
20543341	5	127.0	6.09	154.7	150	1.03	30	762.00	29	736.6	6.01	8.95
20015335	6	152.4	7.22	183.4	150	1.03	36	914.40	29	736.6	8.13	12.11
20556882	6¾	168.3	7.84	199.1	150	1.03	40	1016.00	29	736.6	9.34	13.92
20686385	8	203.2	9.06	230.1	150	1.03	48	1219.20	29	736.6	11.51	17.15
20415228	8¾	219.1	10.03	254.8	150	1.03	52	1320.80	29	736.6	14.35	21.38
20100181	10	254.0	11.38	289.1	150	1.03	60	1524.00	29	736.6	16.40	24.44
20290866	12	304.8	13.47	342.1	150	1.03	72	1828.80	29	736.6	19.83	29.55

*Note: 3/8" and 1/2" tube gauge specs available on request. Contact Customer Service.

Flexible Downspout



Product Specifications

Application

Flexible Downspout is an economical choice for gravity flow service. Install only in a vertical position.

Construction Tube

1/8" Black ChemiTuf® synthetic rubber for abrasion resistance (static dissipating/static conductive)

Cover

Black SBR synthetic rubber (wrapped impression)

Reinforcement

Spiral-plied synthetic fabric

Temperature Range

-25°F to 180°F (-32°C to 82°C)

Packaging

Polywrapped

Branding

Example: Continental ContiTech Flexible Downspout

Couplings

Contact fitting manufacturer for proper fitting recommendation and coupling procedure.

Non-Stock/Sizes

Available up to 18" ID

Order Codes

541-015

Flexible Downspout

SAP #	ID		Nom. OD		Max. WP		Weight	
	in.	mm	in.	mm	psi	MPa	lb./ft.	kg/m
20014797	4	101.6	4.41	111.9	50	0.34	1.28	1.89
20014798	4½	114.3	4.90	124.5	50	0.34	1.46	2.17
20014801	6	152.4	6.40	162.6	35	0.24	1.92	2.86
20014804	6⅝	168.3	7.02	178.3	35	0.24	2.11	3.14
20014808	8	203.2	8.40	213.4	25	0.17	2.54	3.78
20014809	8⅝	219.1	8.99	228.4	25	0.17	2.72	4.05
20014810	10	254.0	10.38	263.7	20	0.14	3.15	4.69
20025244	10¾	273.1	11.23	285.2	20	0.14	3.84	5.71
20014811	12	304.8	12.46	316.5	15	0.10	4.28	6.37
20014812	12¾	323.9	13.21	335.5	15	0.10	4.54	6.76
20014813	14	355.6	14.56	369.9	15	0.10	4.91	7.32
20014816	16	406.4	16.53	419.9	10	0.07	5.59	8.33

Air & Multipurpose
General Purpose
Heavy Duty
Push-on

Chemical Transfer

Cleaning Equipment

Food
Transfer
Washdown

Marine

Material Handling
Abrasives
Bulk Transfer
Cement & Concrete

Mining

Petroleum
Aircraft Fueling
Dispensing
Dock
Transfer

Spray

Steam

Vacuum

LPG Delivery

Water
Discharge
Suction & Discharge
Washdown

Welding

Coupling Systems

Equipment

Appendix

Plicord® Hydrovator™



Air & Multipurpose

- General Purpose
- Heavy Duty
- Push-on

Chemical Transfer

Cleaning Equipment

Food

- Transfer
- Washdown

Marine

Material Handling

- Abrasives
- Bulk Transfer
- Cement & Concrete

Mining

Petroleum

- Aircraft Fueling
- Dispensing
- Dock
- Transfer

Spray

Steam

Vacuum

LPG Delivery

Water

- Discharge
- Suction & Discharge
- Washdown

Welding

Coupling Systems

Equipment

Appendix

Product Specifications

Application

A rugged yet lightweight hose designed exclusively for Hydrovac operations. Plicord® Hydrovator™ from Continental ContiTech combines the best in lightweight design and durability. ChemiTuf® tube handles the toughest Hydro Excavation jobs. The unique corrugated SBR cover provides superior flexibility in all applications. Hydrovator™ Hose rated for full vacuum. All sizes are rated for full vacuum.

Construction Tube

Black natural rubber combined with a static dissipating ChemiTuf® liner.

Cover

Static dissipating black SBR synthetic rubber with a heavy corrugated profile for high flexibility.

Reinforcement

Double helix spiral steel wire with plies of synthetic fabric.

Temperature Range

-25°F to 180°F (-32°C to 82°C)

Packaging

Coiled or straight length.

Branding

Example: Plicord® Hydrovator™ Vacuum Hose

Couplings

Plain end, soft end or enlarged soft end.

Non-Stock/Sizes

Built to length

Order Codes

541-289

Plicord® Hydrovator™

SAP #	ID		Nom. OD		Max. WP		Weight	
	in.	mm	in.	mm	psi	MPa	lb./ft.	kg/m
20435817	6	152.6	7.10	180.3	12	0.24	6.4	2.86
20435818	8	203.5	8.90	226.5	16	0.17	8.4	3.78
20435850	10	253.9	11.10	281.9	20	0.14	11.8	4.69

Plicord® Dredge Sleeve



Product Specifications

Application

The Plicord® Dredge Sleeve is used as a flexible connection between pipe sections on the discharge line of hydraulic-type dredges.

Construction Tube

3/8" ChemiTuf® abrasion-resistant rubber (static dissipating/static conductive). Other gauges available upon request.

Cover

Black SBR synthetic rubber (wrapped impression)

Reinforcement

Multiple plies spirals synthetic and fabric

Temperature Range

-25°F to 180°F (-32°C to 82°C)

Packaging

Polywrapped

Branding

Example: Continental ContiTech Plicord® Dredge Sleeve

Couplings

Contact fitting manufacturer for proper fitting recommendation and coupling procedure.

Order Codes

541-107

Available on request

541-290 1/2" ChemiTuf® tube 150 psi

541-177 1/2" Black Pureten™ 150 psi

541-081 3/4" ChemiTuf® tube 150 psi

541-316 3/4" Black Pureten™ 150 psi

Plicord® Dredge Sleeve

SAP #	ChemiTuf® tube		Black Pureten		Nom. OD		Max. WP		Bend Radius		Weight			
	(1/2)	(3/4)	(1/2)	(3/4)	in.	mm	in.	mm	psi	MPa	in.	mm	lb./ft.	kg/m
20014987	20276210		20286716	20217385	6 ⁵ / ₈	168.3	8.22	208.8	75	0.52	60	1524	9.77	14.54
20014993	20015204		20222676	20217385	8 ⁵ / ₈	219.1	10.31	261.9	75	0.52	80	2032	13.59	20.22
20014999	20015209	20156102	20147951	20143628	10 ³ / ₄	273.1	12.50	317.5	75	0.52	100	2540	16.72	24.88
20169040	20015213	20149436	20148851	20139966	12 ³ / ₄	323.9	14.53	369.1	75	0.52	120	3048	20.04	29.82
20229635	20015217	20157129		20139943	14	355.6	15.89	403.6	75	0.52	140	3556	22.65	33.71
20099933	20015221	20659873	20346340	20276774	16	406.4	17.84	453.1	75	0.52	160	4064	24.91	37.07
20115098	20032603	20264965		20333400	18	457.2	19.94	506.5	75	0.52	180	4572	27.80	41.37

Air & Multipurpose

General Purpose
Heavy Duty
Push-on

Chemical Transfer

Cleaning Equipment

Food

Transfer
Washdown

Marine

Material Handling

Abrasives
Bulk Transfer
Cement & Concrete

Mining

Petroleum

Aircraft Fueling
Dispensing
Dock
Transfer

Spray

Steam

Vacuum

LPG Delivery

Water

Discharge
Suction & Discharge
Washdown

Welding

Coupling Systems

Equipment

Appendix

Plicord® RVC



Air & Multipurpose

- General Purpose
- Heavy Duty
- Push-on

Chemical Transfer

Cleaning Equipment

Food

- Transfer
- Washdown

Marine

Material Handling

- Abrasives
- Bulk Transfer
- Cement & Concrete

Mining

Petroleum

- Aircraft Fueling
- Dispensing
- Dock
- Transfer

Spray

Steam

Vacuum

LPG Delivery

Water

- Discharge
- Suction & Discharge
- Washdown

Welding

Coupling Systems

Equipment

Appendix

Product Specifications

Application

For use on reverse drilling rigs.

Construction Tube

Black ChemiTuf® synthetic rubber: 1/4" Gauge-2"-4" I.D.; 1/2" Gauge-6"; 3/8" Gauge-8"

Cover

Blue SBR synthetic rubber with orange spiral transfer brand (wrapped impression)

Reinforcement

Spiral-ply synthetic fabric: 2" & 3" ID-6 plies; 4" & 6" ID-8 plies; 8" ID-10 plies

Temperature Range

-20°F to 180°F (-29°C to 82°C)

Packaging

2"-4", 100' length, coiled polywrapped; 6"-8", 50' length, shipped straight polywrapped over 6", custom lengths up to 100'

Branding (Spiral)

Example: Continental ContiTech Reverse Circulation 600 psi Max W.P. Made in Canada

Couplings

Contact fitting manufacturer for proper fitting recommendation and coupling procedure.

Non-Stock/Sizes

Custom lengths available.

Order Codes

549-341 (2"-4")
541-341 (6" and 8")

Plicord® RVC

SAP #	ID		Nom. OD		Max. WP		Weight	
	in.	mm	in.	mm	psi	MPa	lb./ft.	kg/m
20019560	2	50.8	3.11	79.0	600	4.14	2.37	3.53
20019565	3	76.2	4.17	105.9	600	4.14	3.39	5.04
20019567	4	101.6	5.39	136.9	600	4.14	5.15	7.66
20015297	6	152.4	7.91	200.9	500	3.45	10.66	15.86

Plicord® Sand Suction



Product Specifications

Application

Plicord® Sand Suction hose is for use on the suction end of hydraulic dredges. It provides a flexible connection between dredging lines and pumps.

Construction Tube

3/8" Black ChemiTuf®w synthetic rubber for abrasion resistance (static dissipating/static conductive). Also available in 1/2" or 3/4" tube gauge.

Cover

Black SBR synthetic rubber (wrapped impression)

Reinforcement

Spiral-plied synthetic fabric with wire helix

Temperature Range

-25°F to 180°F (-32°C to 82°C)

Packaging

Custom lengths polywrapped

Branding

Example: Continental ContiTech Style M Sand Suction

Couplings

Contact fitting manufacturer for proper fitting recommendation and coupling procedure.

Non-Stock/Sizes

Custom lengths available.

Order Codes

541-267 (3/8" tube)

541-268 (3/4" tube)

541-265 (1/2" tube)

Plicord® Sand Suction

SAP #	Black			ID		Nom. OD		Bend Radius		Vacuum HG		Weight	
	(3/8" tube)	(3/4" tube)	(1/2" tube)	in.	mm	in.	mm	in.	mm	in.	mm	lb./ft.	kg/m
20371749	20015144			4	101.6	5.31	134.9	40	1016	30	762	5.71	8.50
20029485	20015145			5	127.0	6.98	177.3	46	1168	30	762	9.47	14.09
20207629		20113822		6	152.4	7.54	191.5	52	1321	30	762	11.35	16.89
20176213				6 5/8	168.3	8.20	208.3	55	1397	30	762	13.96	20.77
20219625	20015150			8	203.2	9.63	244.6	62	1575	30	762	16.93	25.19
20291577		20150200		8 5/8	219.1	10.25	260.4	68	1727	30	762	17.85	26.56
20418594	20015155			10	254.0	11.81	300.0	76	1930	30	762	23.94	35.63
20015186		20015160		10 3/4	273.1	12.63	320.8	82	2083	30	762	25.68	38.22
20221702	20015164			12	304.8	13.91	353.3	91	2311	30	762	28.95	43.08
20015191	20174216	20015171		12 3/4	323.9	14.59	370.6	94	2388	30	762	29.98	44.61

Air & Multipurpose
General Purpose
Heavy Duty
Push-on

Chemical Transfer

Cleaning Equipment

Food
Transfer
Washdown

Marine

Material Handling
Abrasives
Bulk Transfer
Cement & Concrete

Mining

Petroleum
Aircraft Fueling
Dispensing
Dock
Transfer

Spray

Steam

Vacuum

LPG Delivery

Water
Discharge
Suction & Discharge
Washdown

Welding

Coupling Systems

Equipment

Appendix

Spiraflex® Air Seeder Hose



Product Specifications

Air & Multipurpose

- General Purpose
- Heavy Duty
- Push-on

Chemical Transfer

Cleaning Equipment

- Food**
- Transfer
- Washdown

Marine

- Material Handling**
- Abrasives
- Bulk Transfer
- Cement & Concrete

Mining

- Petroleum**
- Aircraft Fueling
- Dispensing
- Dock
- Transfer

Spray

Steam

Vacuum

LPG Delivery

- Water**
- Discharge
- Suction & Discharge
- Washdown

Welding

Coupling Systems

Equipment

Appendix

Application

For dry conveying of seeds and other materials where abrasion is present and service conditions are moderate. Excellent for low-pressure blowing applications.

Construction Tube

Clear thermoplastic urethane

Cover

Clear flexible vinyl

Reinforcement

White rigid vinyl helix

Temperature Range

0°F to 158°F (-18°C to 70°C)

Packaging

Coil wrapped with cardboard and stretch film

Branding

Date code only

Couplings

Contact fitting manufacturer for proper fitting recommendation and coupling procedure.

Order Codes

586-450

Spiraflex® Air Seeder

SAP #	ID	Nom. OD		Max. WP		Bend Radius		Vacuum HG		Weight		
		in.	mm	in.	mm	in.	mm	in.	mm	lb./ft.	kg/m	
20013448	1	25.4	1.25	32.0	60	.41	3	76.19	29	737	.195	0.29
20013450	1½	38.1	1.82	46.2	50	.34	4	101.60	29	737	.320	0.48
20013451	2	50.8	2.37	60.4	40	.27	5	127.00	29	737	.420	0.63
20013452	2½	63.5	2.87	72.9	40	.27	7	177.79	29	737	.650	0.99
20013453	3	76.2	3.42	86.8	35	.24	8	203.20	29	737	.890	1.33
20013454	4	101.6	4.50	114.4	27	.18	11	279.4	29	737	.997	1.48

Spirathane™ HD



Product Specifications

Application

For dry pneumatic conveying of solids where heavy duty abrasive conditions are present. Sizes 1½"-5" rated to full vacuum.

Construction Tube

Polyurethane RMA Class B (Medium Oil Resistance) with improved abrasion resistance

Cover

High-density, low-temperature blue Pliovic® compound

Reinforcement

High-density, rigid Pliovic® PVC helix

Temperature Range

0°F to 158°F (-18°C to 70°C)

Packaging

1½"-6" - 100' lengths, coiled and polywrapped
8"-10" - 0' lengths, polytube with corrugated protection

Branding

Not branded

Couplings

Contact fitting manufacturer for proper fitting recommendation and coupling procedure.

Order Codes

586-407

Spirathane™ HD

SAP #	ID		Nom. OD		Max. WP		Bend Radius		Vacuum HG		Weight	
	in.	mm	in.	mm	psi	MPa	in.	mm	in.	mm	lb./ft.	kg/m
20013134	1½	38.1	1.86	47.2	50	0.34	4	99	29	737	0.34	0.51
20013137	2	50.8	2.47	62.7	50	0.34	6	140	29	737	0.63	0.94
20013138	2½	63.5	3.12	79.3	50	0.34	7	178	29	737	0.95	1.41
20013141	3	76.2	3.64	92.5	40	0.28	8	203	29	737	1.37	2.04
20013144	4	101.6	4.77	121.2	35	0.24	14	356	29	737	1.98	2.95
20013146	5	127.0	5.83	148.1	30	0.21	20	508	29	737	2.41	3.59
20013149	6	152.4	6.84	173.7	23	0.16	25	635	25	635	3.08	4.58
20013150	8	203.2	8.75	222.3	20	0.14	48	1219	25	635	4.53	6.74
20013151	10	254.0	10.96	278.4	20	0.14	75	1905	25	635	6.36	9.46

Air & Multipurpose
General Purpose
Heavy Duty
Push-on

Chemical Transfer

Cleaning Equipment

Food
Transfer
Washdown

Marine

Material Handling
Abrasives
Bulk Transfer
Cement & Concrete

Mining

Petroleum
Aircraft Fueling
Dispensing
Dock
Transfer

Spray

Steam

Vacuum

LPG Delivery

Water
Discharge
Suction & Discharge
Washdown

Welding

Coupling Systems

Equipment

Appendix

Spirathane™ PT



Air & Multipurpose

- General Purpose
- Heavy Duty
- Push-on

Chemical Transfer

Cleaning Equipment

- Food**
- Transfer
- Washdown

Marine

- Material Handling**
- Abrasives
- Bulk Transfer
- Cement & Concrete

Mining

- Petroleum**
- Aircraft Fueling
- Dispensing
- Dock
- Transfer

Spray

Steam

Vacuum

LPG Delivery

- Water**
- Discharge
- Suction & Discharge
- Washdown

Welding

Coupling Systems

Equipment

Appendix



Product Specifications

Application

For the transfer of a variety of dry, bulk and abrasive materials. It is used in applications where static electrical buildup is common. For powders, plastic pellets and granular materials.

Construction Tube

Polyurethane conforms to FDA standards.

Cover

High molecular weight, clear PVC, corrugated for flexibility.

Reinforcement

High-density, rigid Pliovic® PVC helix with static wire placed between tube and cover.

Temperature Range

0°F to 158°F (-18°C to 70°C)

Packaging

100' lengths, coiled and polywrapped

Branding

Not branded

Couplings

Contact fitting manufacturer for proper fitting recommendation and coupling procedure.

Order Codes

586-489

Spirathane™ PT

SAP #	ID		Nom. OD		Max. WP		Bend Radius		Vacuum HG		Weight		
	Clear	in.	mm	in.	mm	psi	MPa	in.	mm	in.	mm	lb./ft.	kg/m
20013682	1½		38.1	1.82	46.2	45	0.31	4	102	29	737	0.31	0.46
20013683	1¾		44.5	2.15	54.6	45	0.31	5	127	29	737	0.38	0.57
20013684	2		50.8	2.38	60.5	30	0.21	6	152	29	737	0.52	0.77
20013685	2¼		57.2	2.77	70.4	35	0.24	7	165	29	737	0.63	0.94
20013686	2½		63.5	3.03	77.0	30	0.21	7	178	29	737	0.69	1.03
20013687	3		76.2	3.63	92.2	30	0.21	8	203	29	737	1.15	1.71
20013688	4		101.6	4.76	120.9	27	0.19	14	356	29	737	1.63	2.43
20046048	5		127.0	5.83	148.1	27	0.19	20	508	29	737	2.13	3.17

Spirathane™ LD



Product Specifications

Application

For dry pneumatic conveying of solid fines where abrasion is present and service conditions are moderate. Excellent for low-pressure blowing applications.

Construction Tube

Clear Polyurethane, RMA Class B (Medium Oil Resistance)

Reinforcement

High-density rigid white Pliovic® helix

Temperature Range

0°F to 158°F (-18°C to 70°C)

Packaging

1½'-6' - 100' lengths, coiled and polywrapped
8'-10' - 20' lengths, polywrapped with corrugated protection

Branding

Not branded

Couplings

Contact fitting manufacturer for proper fitting recommendation and coupling procedure.

Order Codes

586-406

Spirathane™ LD

SAP #	ID	Nom. OD		Max. WP		Bend Radius		Vacuum HG		Weight		
		in.	mm	in.	mm	psi	MPa	in.	mm	in.	mm	lb./ft.
20013121	1½	38.1	1.84	46.7	30	0.21	2	51	22	559	0.25	0.37
20013123	2	50.8	2.35	59.7	25	0.17	3	71	21	533	0.34	0.51
20013124	2½	63.5	2.89	73.4	20	0.14	4	89	19	483	0.44	0.65
20013125	3	76.2	3.45	87.6	20	0.14	4	102	18	457	0.60	0.89
20013127	4	101.6	4.53	115.1	15	0.10	7	178	13	330	0.88	1.31
20013128	5	127.0	5.56	141.2	10	0.07	8	203	10	254	1.09	1.62
20013130	6	152.4	6.57	166.9	10	0.07	12	305	7	178	1.53	2.28
20013131	8	203.2	8.59	218.2	6	0.04	23	584	5	127	1.73	2.57
20013133	10	254.0	10.75	273.1	5	0.03	30	762	4	102	2.75	4.09

Air & Multipurpose

General Purpose
Heavy Duty
Push-on

Chemical Transfer

Cleaning Equipment

Food

Transfer
Washdown

Marine

Material Handling

Abrasives
Bulk Transfer
Cement & Concrete

Mining

Petroleum

Aircraft Fueling
Dispensing
Dock
Transfer

Spray

Steam

Vacuum

LPG Delivery

Water

Discharge
Suction & Discharge
Washdown

Welding

Coupling Systems

Equipment

Appendix

Bulk Transfer



Air & Multipurpose

- General Purpose
- Heavy Duty
- Push-on

Chemical Transfer

Cleaning Equipment

Food

- Transfer
- Washdown

Marine

Material Handling

- Abrasives
- Bulk Transfer
- Cement & Concrete

Mining

Petroleum

- Aircraft Fueling
- Dispensing
- Dock Transfer

Spray

Steam

Vacuum

LPG Delivery

Water

- Discharge
- Suction & Discharge
- Washdown

Welding

Coupling Systems

Equipment

Appendix

	Page	Food Grade	Static Dissipating/ Static Conductive Tube	Temp. Range	Suction	Discharge Only
Black Softwall	133		Yes	-25°F to 180°F (-32°C to 82°C)		Yes
Flextra Dry Material	132		Yes	-40°F to 180°F (-40°C to 82°C)	Yes	
Spiraflex Mulch Blower	137			0°F to 158°F (-18°C to 70°C)		
Plicord Torridair Hot Air Blower	134			-40°F to 400°F (-40°C to 205°C)	Yes	
Pyroflex II Hot Air	135			-20°F to 325°F (-29°C to 163°C)	Yes	
Pyroflex III Hot Air	136	Yes		-20°F to 325°F (-29°C to 163°C)	Yes	
Tan Flextra	139	Yes		-40°F to 180°F (-40°C to 82°C)	Yes	
Tan Flexwing	138	Yes		-40°F to 180°F (-40°C to 82°C)	Yes	
Tan Softwall	140	Yes		-40°F to 180°F (-40°C to 82°C)		Yes

Flextra® Dry Material



Product Specifications

Application

A static dissipating/static conductive hose for tank truck and in-plant service. Used to convey non-oily abrasive materials such as sand, limestone and plastic pellets. Recommended where static buildup can be a problem.

Construction Tube

3/16" Gauge Black ChemiTuf® synthetic rubber (static dissipating/static conductive)

Cover

Black SBR synthetic rubber (corrugated) with yellow spiral band (wrapped impression)

Reinforcement

Spiral-plied synthetic fabric with wire helix

Temperature Range

-40°F to 180°F (-40°C to 82°C)

Packaging

100' lengths, coiled and polywrapped

Branding (Spiral)

Example: Continental ContiTech Flextra® Dry Material 75 psi WP

Couplings

Contact fitting manufacturer for proper fitting recommendation and coupling procedure.

Order Codes

549-126

Flextra® Dry Material

SAP #	ID	Nom. OD		Max. WP		Bend Radius		Vacuum HG		Weight		
		in.	mm	in.	mm	psi	MPa	in.	mm	in.	mm	lb./ft.
20421726	1½	38.1	2.11	53.6	75	0.52	4	89	29	737	1.03	1.53
20019229	2	50.8	2.63	66.8	75	0.52	4	102	29	737	1.29	1.92
20019230	3	76.2	3.69	93.7	75	0.52	6	152	29	737	2.15	3.20
20019233	4	101.6	4.75	120.7	75	0.52	9	229	29	737	3.09	4.60
20019234	5	127.0	5.78	146.9	75	0.52	20	500	29	737	4.16	6.20
20019235	6	152.4	6.81	173.1	75	0.52	24	600	29	737	5.47	8.15

Air & Multipurpose

General Purpose
Heavy Duty
Push-on

Chemical Transfer

Cleaning Equipment

Food
Transfer
Washdown

Marine

Material Handling
Abrasives
Bulk Transfer
Cement & Concrete

Mining

Petroleum
Aircraft Fueling
Dispensing
Dock
Transfer

Spray

Steam

Vacuum

LPG Delivery

Water
Discharge
Suction & Discharge
Washdown

Welding

Coupling Systems

Equipment

Appendix

Black Softwall



Air & Multipurpose

- General Purpose
- Heavy Duty
- Push-on

Chemical Transfer

Cleaning Equipment

- Food Transfer
- Washdown

Marine

- Material Handling**
- Abrasives
- Bulk Transfer
- Cement & Concrete

Mining

- Petroleum**
- Aircraft Fueling
- Dispensing
- Dock Transfer

Spray

Steam

Vacuum

LPG Delivery

- Water**
- Discharge
- Suction & Discharge
- Washdown

Welding

Coupling Systems

Equipment

Appendix

Product Specifications

Application

For the discharge of dry bulk cement from tank truck and in-plant service.

Construction Tube

1/8" (static dissipating/static conductive) Black ChemiTuf® synthetic rubber. Available in 1/8", 3/16", and 1/4" tube gauges

Cover

Black SBR synthetic rubber with white spiral stripe (wrapped impression)

Reinforcement

Spiral-plied synthetic fabric

Temperature Range

-25°F to 180°F (-32°C to 82°C)

Packaging

100' lengths, coiled and polywrapped

Branding (Spiral)

Example: Continental ContiTech Black Softwall

Black Softwall

Order Codes: 549-152-0

SAP #		Dia.	ID	OD	Weight
(1/8")	Survivor Compound	PO	mm	mm	#/ft.
20019306		3	76.1	86.3	1.05
20019309	20665783	4	102.1	112.3	1.38
20046192		4½	114.6	125.4	1.64
20019315	20677559	5	127.4	138.2	1.82
20019319		6	152.7	163.9	2.25

Couplings

Contact fitting manufacturer for proper fitting recommendation and coupling procedure. Use Continental ContiTech Insta-Lock™ Cam & Groove Fittings with this product. See the Coupling Systems information pages at the back of the catalog.

Order Codes

- 549-152 (1/8" tube gauge 50 psi)
- 549-149 (3/16" tube gauge 75 psi)
- 549-148 (1/4" tube gauge 50 psi)

Black Softwall

Order Codes: 549-149-0

SAP #		Dia.	ID	OD	Weight
(3/16")	Survivor Compound	PO	mm	mm	#/ft.
20019281	20673663	4	102.1	116.2	1.92
20029627		4½	114.6	129.0	2.21
20109496		5	127.4	141.8	2.44
20468267		5½	140.1	154.5	2.67
20446687		6	152.7	167.7	3.01

Black Softwall

Order Codes: 549-148-0

SAP #		Dia.	ID	OD	Weight
(1/4")	Survivor Compound	PO	mm	mm	#/ft.
20019277	20639327	4	102.1	118.7	2.29
20311113		4½	114.6	131.8	2.65
20019279		5	127.4	145.0	3
20019280		6	152.7	170.3	3.56

Plicord® Torridair™ Hot Air Blower



Product Specifications

Application

Designed to transfer hot, non-oily air, up to 400°F (204°C), from manifold blowers or in-plant compressors to holding tanks used in the transfer of dry bulk materials.

Construction Tube

Black, STF (Super Thermo-Flo) EPDM synthetic rubber

Cover

Black, weather-resistant, STF (Super Thermo-Flo) EPDM synthetic rubber (wrapped impression)

Reinforcement

Spiral-plied synthetic fabric with double wire helix

Temperature Range

-40°F to 400°F (-40°C to 204°C)

Packaging

100' lengths, coiled and polywrapped

Branding (Spiral)

Example: Continental ContiTech Torridair™ Blower Hose 400°F (204°C)

Couplings

Contact fitting manufacturer for proper fitting recommendation and coupling procedure. Use Continental ContiTech Insta-Lock™ Cam & Groove Fittings with this product. See the Coupling Systems information pages at the back of the catalog.

Order Codes

549-856

Plicord® Torridair™

SAP #	ID	Nom. OD		Max. WP		Bend Radius		Vacuum HG		Weight		
		in.	mm	in.	mm	in.	mm	in.	mm	lb./ft.	kg/m	
20020255	2	50.8	2.51	63.8	100	0.69	5	127	29	737	1.06	1.58
20020257	2½	63.5	3.00	76.2	100	0.69	6	152	29	737	1.35	2.01
20020260	3	76.2	3.53	89.7	100	0.69	7	178	29	737	1.84	2.74
20020261	4	101.6	4.60	116.8	100	0.69	16	400	29	737	2.47	3.68
20130428	6	152.4	6.70	170.0	100	0.69	30	750	29	737	4.46	6.65

Air & Multipurpose

General Purpose
Heavy Duty
Push-on

Chemical Transfer

Cleaning Equipment

Food
Transfer
Washdown

Marine

Material Handling
Abrasives
Bulk Transfer
Cement & Concrete

Mining

Petroleum
Aircraft Fueling
Dispensing
Dock
Transfer

Spray

Steam

Vacuum

LPG Delivery

Water
Discharge
Suction & Discharge
Washdown

Welding

Coupling Systems

Equipment

Appendix

Pyroflex® II Hot Air



Air & Multipurpose

- General Purpose
- Heavy Duty
- Push-on

Chemical Transfer

Cleaning Equipment

- Food**
- Transfer
- Washdown

Marine

- Material Handling**
- Abrasives
- Bulk Transfer
- Cement & Concrete

Mining

- Petroleum**
- Aircraft Fueling
- Dispensing
- Dock
- Transfer

Spray

Steam

Vacuum

LPG Delivery

- Water**
- Discharge
- Suction & Discharge
- Washdown

Welding

Coupling Systems

Equipment

Appendix

Product Specifications

Application

For conveying hot air from compressors to tanks on bulk dry material carriers.

Construction Tube

Black heat-resistant EPDM synthetic rubber

Cover

Heat-resistant black EPDM synthetic rubber with orange spiral stripe (wrapped impression)

Reinforcement

Spiral-plyed synthetic fabric with wire helix

Temperature Range

-20°F to 325°F (-29°C to 163°C)

Packaging

100' lengths, coiled and polywrapped

Branding (Spiral)

Example: Continental ContiTech Pyroflex® II Hot Air

Couplings

Contact fitting manufacturer for proper fitting recommendation and coupling procedure. Use Continental ContiTech Insta-Lock™ Cam & Groove Fittings with this product. See the Coupling Systems information pages at the back of the catalog.

Order Codes

549-394

Pyroflex® II Hot Air

SAP #	ID	Nom. OD		Max. WP		Bend Radius		Vacuum HG		Weight		
Black	in.	mm	in.	mm	psi	MPa	in.	mm	in.	mm	lb./ft.	kg/m
20019669	2	50.8	2.55	64.8	100	0.69	5	127	29	737	1.22	1.82
20019671	3	76.2	3.55	90.2	100	0.69	7	178	29	737	1.93	2.87
20019674	4	101.6	4.61	117.1	100	0.69	10	254	29	737	2.65	3.94
20019675	6	152.4	6.74	171.1	100	0.69	30	750	29	737	4.80	7.15

Pyroflex® III Hot Air



Product Specifications

Application

For conveying hot air with FDA compliant tube that can be used in unloading edible materials.

Construction Tube

White EPDM - FDA compliant

Cover

Red Standard EPDM

Reinforcement

Spiral-plied synthetic fabric with wire helix

Temperature Range

-20°F to 325°F (-28.8°C to 162.8°C)

Packaging

100' lengths, coiled and polywrapped

Branding (Spiral)

Example: Continental ContiTech Pyroflex® III Hot Air Blower - FDA Compliant Made in Canada

Couplings

Use Continental ContiTech Insta-Lock Cam & Groove Fittings with this product. Other fitting types contact fitting company.

Non-Stock/Sizes

100 ft. for stock and 400 ft. for MTO

Order Codes

549-952

Pyroflex® III Hot Air

SAP #	Nom. ID		Nom. OD		Max. WP		Bend Radius		Vacuum HG		Weight	
	in.	mm	in.	mm	psi	MPa	in.	mm	in.	mm	lb./ft.	kg/m
20762191	1½	3.81	2.04	51.7	100	0.69	4	101.6	29	737	0.94	1.4
20762192	2	50.8	2.55	64.8	100	0.69	5	127	29	737	1.24	1.85
20762193	2½	63.5	3.06	77.8	100	0.69	6	152.4	29	737	1.67	2.49
20762194	3	76.2	3.56	90.5	100	0.69	7	178	29	737	1.97	2.94
20762195	4	101.6	4.61	117.1	100	0.69	10	254	29	737	2.72	4.05

Air & Multipurpose

General Purpose
Heavy Duty
Push-on

Chemical Transfer

Cleaning Equipment

Food

Transfer
Washdown

Marine

Material Handling

Abrasives
Bulk Transfer
Cement & Concrete

Mining

Petroleum

Aircraft Fueling
Dispensing
Dock
Transfer

Spray

Steam

Vacuum

LPG Delivery

Water

Discharge
Suction & Discharge
Washdown

Welding

Coupling Systems

Equipment

Appendix

Spiraflex® Mulch Blower



Product Specifications

Air & Multipurpose

- General Purpose
- Heavy Duty
- Push-on

Chemical Transfer

Cleaning Equipment

- Food**
- Transfer
- Washdown

Marine

- Material Handling**
- Abrasives
- Bulk Transfer
- Cement & Concrete

Mining

- Petroleum**
- Aircraft Fueling
- Dispensing
- Dock
- Transfer

Spray

Steam

Vacuum

LPG Delivery

- Water**
- Discharge
- Suction & Discharge
- Washdown

Welding

Coupling Systems

Equipment

Appendix

Application

A high-strength, mulch-blowing hose that's flexible and durable. It provides visible, unrestricted material applications in a buildup and hose balance.

Sprays mulch, woodchips and other materials for landscaping applications in a wide range of environments.

Construction Tube

Clear High Molecular Weight PVC

Reinforcement

Yellow Rigid PVC Helix

Temperature Range

0°F to 158°F (-18°C to 70°C)

Packaging

100' coils covered with stretch film and cardboard

Branding

Not branded

Stock Sizes

4" and 5"

Order Codes

586-553

SpiraFlex® Mulch Blower

SAP #	ID		Nom. OD		Max. WP Bend Radius			Vacuum HG		Weight	
	in.	mm	in.	mm	psi	in.	mm	in.	mm	lb./ft.	kg/m
20013644	4	101.6	5.02	127.4	15	6	152.4	29	737	1.05	0.15
20024982	5	127	5.61	142.4	15	9	228.6	29	737	1.25	0.17

Tan Flexwing®



Product Specifications

Application

Tan Flexwing® is for acids, alcohol bases and salt solutions.

Construction Tube

Tan Pureten™ gum rubber (non oil-resistant) (FDA/USDA compliant)

Cover

Tan SBR synthetic rubber (non oil-resistant) with blue spiral stripe (wrapped impression)

Reinforcement

Spiral-plied synthetic fabric with wire helix

Temperature Range

-40°F to 180°F (-40°C to 82°C)

Packaging

100' lengths, coiled and polywrapped

Branding (Spiral)

Example: Continental ContiTech Tan Flexwing® with Pureten™ 150 psi WP

Couplings

Contact fitting manufacturer for proper fitting recommendation and coupling procedure.

Order Codes

546-068

Tan Flexwing®

SAP #	ID	Nom. OD		Max. WP		Bend Radius		Vacuum HG		Weight		
		in.	mm	in.	mm	in.	mm	in.	mm	lb./ft.	kg/m	
20018549	1	25.4	1.61	40.9	150	1.03	3.5	89	29	737	0.75	1.12
20050636	1½	38.1	2.14	54.4	150	1.03	4.0	102	29	737	1.08	1.61
20018551	2	50.8	2.68	68.1	150	1.03	5.0	127	29	737	1.44	2.14
20018555	3	76.2	3.75	95.3	150	1.03	7.0	178	29	737	2.32	3.45
20018557	4	101.6	4.83	122.7	150	1.03	10.0	254	29	737	3.39	5.04
20221775	6	152.4	6.96	176.8	150	1.03	30.0	762	29	737	6.04	8.99

Air & Multipurpose
General Purpose
Heavy Duty
Push-on

Chemical Transfer

Cleaning Equipment

Food
Transfer
Washdown

Marine

Material Handling
Abrasives
Bulk Transfer
Cement & Concrete

Mining

Petroleum
Aircraft Fueling
Dispensing
Dock
Transfer

Spray

Steam

Vacuum

LPG Delivery

Water
Discharge
Suction & Discharge
Washdown

Welding

Coupling Systems

Equipment

Appendix

Tan Flextra®



Air & Multipurpose

- General Purpose
- Heavy Duty
- Push-on

Chemical Transfer

Cleaning Equipment

- Food Transfer
- Washdown

Marine

- Material Handling**
- Abrasives
- Bulk Transfer
- Cement & Concrete

Mining

- Petroleum**
- Aircraft Fueling
- Dispensing
- Dock Transfer

Spray

Steam

Vacuum

LPG Delivery

- Water**
- Discharge
- Suction & Discharge
- Washdown

Welding

Coupling Systems

Equipment

Appendix

Product Specifications

Application

For tank truck and in-plant service. Used to convey non-oily abrasive materials such as sand, limestone, plastic pellets and dry abrasive food products.

Construction Tube

Pureten™ gum rubber (FDA/USDA compliant)

Cover

Tan SBR gum rubber (corrugated) with yellow spiral stripe (wrapped impression)

Reinforcement

Spiral-plied synthetic fabric with wire helix

Temperature Range

-40°F to 180°F (-40°C to 82°C)

Packaging

1½'-4' - 100' lengths, coiled and polywrapped
5'-6" - 50' lengths, coiled and polywrapped

Branding (Spiral)

Example: Continental ContiTech Tan Flextra® with Pureten™ 75 psi WP

Couplings

Contact fitting manufacturer for proper fitting recommendation and coupling procedure.

Order Codes

549-116

Tan Flextra®

SAP #	ID	Nom. OD		Max. WP		Bend Radius		Vacuum HG		Weight		
		in.	mm	in.	mm	in.	mm	in.	mm	lb./ft.	kg/m	
20019210	1½	38.0	2.09	53.1	75	0.52	4	102	29	737	0.99	1.47
20019212	2	50.8	2.60	66.0	75	0.52	4	102	29	737	1.21	1.80
20019216	3	76.2	3.63	92.2	75	0.52	6	152	29	737	1.94	2.89
20019217	4	101.6	4.69	119.1	75	0.52	9	229	29	737	2.74	4.08
20132671	5	127.0	5.78	146.8	75	0.52	12	305	29	737	4.26	6.34
20019224	6	152.4	6.78	172.2	75	0.52	15	381	29	737	4.92	7.32

Tan Softwall



Product Specifications

Application

A fabric-reinforced hose for the discharge of non-oily abrasive materials such as sand, limestone, gravel, plastic pellets and dry food products. For use where static electrical buildup is not a problem.

Construction Tube

Tan Pureten™ gum rubber (FDA/USDA compliant)

Cover

Tan SBR synthetic rubber (wrapped impression)

Reinforcement

Spiral-plied synthetic fabric with static wire

Temperature Range

-40°F to 180°F (-40°C to 82°C)

Packaging

2"-4" - 100' lengths, coiled and polywrapped
5"-6" - 50' lengths, coiled and polywrapped

Branding (Spiral)

Example: Continental ContiTech Tan Softwall with Pureten™
75 psi WP

Couplings

Contact fitting manufacturer for proper fitting recommendation and coupling procedure.

Order Codes

549-040

Tan Softwall

SAP #	ID		Nom. OD		Max. WP		Weight	
	in.	mm	in.	mm	psi	MPa	lb./ft.	kg/m
20045907	2	50.8	2.68	68.1	75	0.52	1.22	1.82
20019116	3	76.2	3.69	93.7	75	0.52	1.80	2.68
20019118	4	101.6	4.78	121.4	75	0.52	2.61	3.88
20019119	5	127.0	5.77	146.6	75	0.52	3.19	4.75
20019120	6	152.4	6.77	172.0	75	0.52	3.78	5.63

Air & Multipurpose

General Purpose
Heavy Duty
Push-on

Chemical Transfer

Cleaning Equipment

Food

Transfer
Washdown

Marine

Material Handling

Abrasives
Bulk Transfer
Cement & Concrete

Mining

Petroleum

Aircraft Fueling
Dispensing
Dock
Transfer

Spray

Steam

Vacuum

LPG Delivery

Water

Discharge
Suction & Discharge
Washdown

Welding

Coupling Systems

Equipment

Appendix

Cement & Concrete



Air & Multipurpose

- General Purpose
- Heavy Duty
- Push-on

Chemical Transfer

Cleaning Equipment

Food

- Transfer
- Washdown

Marine

Material Handling

- Abrasives
- Bulk Transfer
- Cement & Concrete

Mining

Petroleum

- Aircraft Fueling
- Dispensing
- Dock
- Transfer

Spray

Steam

Vacuum

LPG Delivery

Water

- Discharge
- Suction & Discharge
- Washdown

Welding

Coupling Systems

Equipment

Appendix

	Page	Textile	Wire
Allcrete Textile Plaster, Grout & Concrete	143	Yes	
Allcrete Wire	144		Yes
PGC Placement Textile	145	Yes	
Plicord Auger Arc Piling	142	Yes	
Plicord Gunite Tan	146	Yes	

Plicord® Auger Arc Piling



Product Specifications

Application

For use in handling a multitude of materials being pumped to concrete forms and structures.

Construction Tube

Black ChemiTuf®

Cover

Black SBR with gray abrasion-resistant spiral strip

Reinforcement

6 fabric plies with boot straps

Temperature Range

-35°F to 180°F (-37°C to 82°C)

Packaging

50' lengths, coiled and poly-wrapped

Branding (Spiral)

Example: Continental ContiTech Auger Arc Piling

Couplings

Contact fitting manufacturer for proper fitting recommendation and coupling procedure.

Order Codes

549-815

Plicord® Auger Arc Piling

SAP #	ID		Nom. OD		Max. WP		Weight	
	in.	mm	in.	mm	psi	MPa	lb./ft.	kg/m
20046556	2	50.8	3.03	77.0	1000	6.9	1.92	2.86
20032406	2½	63.5	3.48	88.4	800	5.5	2.18	3.24
20032476	3	76.2	4.02	102.1	800	5.5	2.66	3.96

Air & Multipurpose

General Purpose
Heavy Duty
Push-on

Chemical Transfer

Cleaning Equipment

Food

Transfer
Washdown

Marine

Material Handling

Abrasives
Bulk Transfer
Cement & Concrete

Mining

Petroleum

Aircraft Fueling
Dispensing
Dock
Transfer

Spray

Steam

Vacuum

LPG Delivery

Water

Discharge
Suction & Discharge
Washdown

Welding

Coupling Systems

Equipment

Appendix

Allcrete® Textile Plaster, Grout & Concrete



Air & Multipurpose
General Purpose
Heavy Duty
Push-on

Chemical Transfer

Cleaning Equipment

Food
Transfer
Washdown

Marine

Material Handling
Abrasives
Bulk Transfer
Cement & Concrete

Mining

Petroleum
Aircraft Fueling
Dispensing
Dock
Transfer

Spray

Steam

Vacuum

LPG Delivery

Water
Discharge
Suction & Discharge
Washdown

Welding

Coupling Systems

Equipment

Appendix

Product Specifications

Application

For use in plaster & grout and shotcrete applications, handling a multitude of materials being pumped to concrete structures, dams, tunnel faces, swimming pools, etc. For use as a flexible connection between pumping equipment and hard piping. Exceeds ASME B30.27-2009. 2:1 WP to burst ratio.

Construction Tube

Black ChemiTuf® synthetic rubber

Cover

Black SBR rubber (wrapped impression)

Reinforcement

Spiral-plied high-strength fabric

Temperature Range

-25°F to 180°F (-32°C to 82°C)

Packaging

50' lengths, coiled and polywrapped

Branding (Spiral)

Example: Allcrete® Textile Ply Plaster, Grout and Concrete Continental ContiTech 2" 1233 psi / 85 Bars WP. Weight filled with concrete (150 lbs/ft³). Exceeds ASME B30.27-2009

Couplings

Contact fitting manufacturer for proper fitting recommendation and coupling procedure.

Order Codes

549-638, Survivor 549-802

Allcrete® Textile

SAP #	Survivor Compound	ID		Nom. OD		Max. WP		Weight	
		in.	mm	in.	mm	psi	MPa	lb./ft.	kg/m
20019934	20677614	1	25.4	1.67	42.3	1233	8.5	0.67	1.00
20019938		1¼	32.0	1.93	49.0	1233	8.5	0.80	1.19
20019942	20673536	1½	38.1	2.31	58.7	1233	8.5	1.14	1.70
20019947	20673537 (50ft) 20673538 (100ft)	2	51.6	2.83	71.8	1233	8.5	1.46	2.18
20019960	20673539	2½	63.7	3.40	86.3	1233	8.5	1.96	2.92
20019965	20673580	3	76.1	3.92	99.6	1233	8.5	2.39	3.56
20019971		4	102.1	4.96	126.0	1233	8.5	3.16	4.67
20164566		5	127.0	6.06	153.3	1233	8.5	4.22	6.25

Allcrete® Wire



Product Specifications

Application

For handling wet concrete with high head pressures at the critical flex areas of a concrete boom truck and as a discharge hose on the delivery end of high-pressure concrete pumps. Exceeds ASME B30.27-2009. 2:1 WP to burst ratio.

Construction Tube

Black ChemiTuf® synthetic rubber

Cover

Black SBR rubber (wrapped impression)

Reinforcement

Spiral-plied high-strength wire

Temperature Range

-40°F to 180°F (-40°C to 82°C)

Packaging

50' lengths, coiled and polywrapped

Branding (Spiral)

Allcrete® Steel Reinforced Concrete Hose Continental ContiTech 3" ID 1233 psi / 85 Bars WP. Weight filled with concrete (150 lbs/ft³). Exceeds ASME B30.27-2009

Couplings

Contact fitting manufacturer for proper fitting recommendation and coupling procedure.

Order Codes

549-670

Allcrete® Wire

SAP #	ID		Nom. OD		Max. WP		Bend Radius		Weight	
	in.	mm	in.	mm	psi	MPa	in.	mm	lb./ft.	kg/m
20032690	2	50.8	3.01	76.4	1233	8.5	9	275	2.75	4.10
20672114	2½	63.5	3.50	88.9	1233	8.5	12	300	3.28	4.92
20020019	3	76.2	3.98	101.3	1233	8.5	14	350	3.80	5.65
20020022	4	101.6	5.02	127.4	1233	8.5	16	400	4.90	7.29
20020026	5	127.0	6.00	152.5	1233	8.5	20	500	5.98	8.90

Air & Multipurpose
General Purpose
Heavy Duty
Push-on

Chemical Transfer

Cleaning Equipment

Food
Transfer
Washdown

Marine

Material Handling
Abrasives
Bulk Transfer
Cement & Concrete

Mining

Petroleum
Aircraft Fueling
Dispensing
Dock
Transfer

Spray

Steam

Vacuum

LPG Delivery

Water
Discharge
Suction & Discharge
Washdown

Welding

Coupling Systems

Equipment

Appendix

PGC Placement Textile



Air & Multipurpose
 General Purpose
 Heavy Duty
 Push-on

Chemical Transfer

Cleaning Equipment

Food
 Transfer
 Washdown

Marine

Material Handling
 Abrasives
 Bulk Transfer
 Cement & Concrete

Mining

Petroleum
 Aircraft Fueling
 Dispensing
 Dock
 Transfer

Spray

Steam

Vacuum

LPG Delivery

Water
 Discharge
 Suction & Discharge
 Washdown

Welding

Coupling Systems

Equipment

Appendix

Product Specifications

Application

An economical version of our Plicord® Allcrete® Textile hose. For use in plaster & grout and shotcrete applications, handling a multitude of materials being pumped to concrete structures, dams, tunnel faces, swimming pools, etc. Meets ASME B30.27-2009. 2:1 WP to burst ratio.

Construction Tube

Black ChemiTuf® synthetic rubber

Cover

Black SBR rubber (wrapped impression).

Reinforcement

Spiral-plied high-strength fabric.

Temperature Range

-25°F to 180°F (-32°C to 82°C)

Packaging

50' lengths, coiled and polywrapped.

Branding (Spiral)

Continental ContiTech PGC Concrete 1,233 psi / 85 Bars WP

Couplings

Contact fitting manufacturer for proper fitting recommendation and coupling procedure.

Order Codes

549-822

PGC Placement Textile

SAP #	ID	Nom. OD			Max. WP		Weight	
		in.	mm	in.	mm	psi	MPa	lb./ft.
20560651	1	25.3	1.56	39.7	1,233	8.5	0.58	0.86
20560652	1¼	32.0	1.88	47.7	1,233	8.5	0.76	1.13
20528827	1½	38.0	2.13	53.7	1,233	8.5	0.87	1.30
20528900	2	51.2	2.69	67.1	1,233	8.5	1.13	1.68
20528902	2½	63.4	3.25	82.3	1,233	8.5	1.59	2.37
20528904	3	76.1	3.81	96.8	1,233	8.5	2.12	3.16
20560653	3½	90.0	4.38	111.9	1,233	8.5	2.63	3.92
20560654	4	102.0	4.94	125.6	1,233	8.5	3.10	4.62

Plicord® Guniting Tan



Product Specifications

Application

For the efficient transfer of sand and cement to the placement mixing gun nozzle. Recommended for all types of gunning applications.

Construction Tube

Tan Pureten™ gum rubber or black ChemiTuf® rubber

Cover

Tan SBR synthetic rubber (wrapped impression)

Reinforcement

Spiral-plied synthetic fabric

Temperature Range

-40°F to 180°F (-40°C to 82°C)

Packaging

50' lengths, coiled and polywrapped

Branding (Spiral)

Example: Continental ContiTech Guniting 150 Max WP

Couplings

Contact fitting manufacturer for proper fitting recommendation and coupling procedure.

Order Codes

549-862 (tan Pureten™)

549-863 (black ChemiTuf®)

549-865 (tan Pureten™ with anti-static wires)

Plicord® Guniting

SAP #			ID		Nom. OD		Max. WP		Weight	
Tan Pureten	Black ChemiTuf®	Tan Pureten with anti-static wires	in.	mm	in.	mm	psi	MPa	lb./ft.	kg/m
20020272			1¼	31.8	2.16	54.9	150	1.03	1.24	1.85
20020274	20020282	20020287	1½	38.1	2.43	61.7	150	1.03	1.48	2.20
20020277		20020290	1¾	41.3	2.58	65.5	150	1.03	1.60	2.38
20020278			1¾	44.5	2.70	68.6	150	1.03	1.68	2.50
20020279	20020283	20020291	2	50.8	2.94	74.7	150	1.03	1.86	2.77

Air & Multipurpose
General Purpose
Heavy Duty
Push-on

Chemical Transfer

Cleaning Equipment

Food
Transfer
Washdown

Marine

Material Handling
Abrasives
Bulk Transfer
Cement & Concrete

Mining

Petroleum
Aircraft Fueling
Dispensing
Dock
Transfer

Spray

Steam

Vacuum

LPG Delivery

Water
Discharge
Suction & Discharge
Washdown

Welding

Coupling Systems

Equipment

Appendix

Mining



Air & Multipurpose

General Purpose
Heavy Duty
Push-on

Chemical Transfer

Cleaning Equipment

Food

Transfer
Washdown

Marine

Material Handling

Abrasives
Bulk Transfer
Cement & Concrete

Mining

Petroleum

Aircraft Fueling
Dispensing
Dock
Transfer

Spray

Steam

Vacuum

LPG Delivery

Water

Discharge
Suction & Discharge
Washdown

Welding

Coupling Systems

Equipment

Appendix

	Page	Thermo- plastic	Rubber	MSHA	Temp. Range	Static Dissipating Tube
Brigade Mine	149	Yes		Yes	-10°F to 150°F (-23°C to 66°C)	
Flextra Rock Dust	150		Yes	Yes	-25°F to 200°F (-32°C to 93°C)	Yes
M&P Mine Conduit	151		Yes	Yes	-20°F to 200°F (-29°C to 93°C)	
Mine Spray	148		Yes	Yes	0°F to 212°F (-18°C to 100°C)	
Plicord Ammonium Nitrate HD	153		Yes		-25°F to 200°F (-32°C to 93°C)	Yes
Plicord Ammonium Nitrate Pellet	152		Yes		-25°F to 200°F (-32°C to 93°C)	Yes
Plicord Mine Conduit	154		Yes	Yes	-40°F to 200°F (-40°C to 93°C)	
Spiraflex Cable Guard	155	Yes		Yes	0°F to 150°F (-18°C to 66°C)	
Spiraflex Red	242	Yes		Yes	-10°F to 150°F (-23°C to 66°C)	
Spiraflex Rock Dust	156	Yes		Yes	0°F to 158°F (-18°C to 70°C)	
Spiraflex Yellow	243	Yes		Yes	-10°F to 150°F (-23°C to 66°C)	
Steel Air	28			Yes	-40°F to 200°F (-40°C to 93°C)	
Super Ortac	29			Yes	-20°F to 212°F (-29°C to 100°C)	

Mine Spray



Product Specifications

Application

For general underground water spray service in dust control applications. It is also used on continuous mining machinery at the headface and on other mechanical mining machines.

Construction Tube

Nitrile synthetic rubber RMA Class B (Medium Oil Resistance)

Cover

Yellow Chemivic™ synthetic rubber RMA Class B (Medium Oil Resistance) (Meets flame test requirements of MSHA Schedule 26-Section 18.65), smooth finish

Reinforcement

Braided (1) steel wire

Temperature Range

0°F to 212°F (-18°C to 100°C)

Packaging

3/4" - 500' reels or 50' cut lengths, 20 pieces per carton
 1" - 500' reels or 50' cut lengths, 12 pieces per carton
 1¼" - 500' reels or 50' cut lengths, 8 pieces per carton
 1½" - 300' reels or 50' cut lengths, 6 pieces per carton
 2" - 50' cut lengths, 4 pieces per carton

Branding

Example: Continental ContiTech 1" Mine Spray 1000 psi WP, Fire-Resistant, USMSHA 2G-IC-14C/38. Made in U.S.A.

Couplings

See Continental ContiTech Hose Assembly Manual for most current crimp solutions.

Order Codes

539-421

Mine Spray

SAP #	ID		Nom. OD		Max. WP		Weight	
	in.	mm	in.	mm	psi	MPa	lb./ft.	kg/m
20024121	3/4	19.1	1.14	29.0	1000	6.9	0.44	0.65
20024129	1	25.4	1.45	36.8	1000	6.9	0.63	0.94
20024138	1¼	31.8	1.75	44.5	1000	6.9	0.86	1.28
20024143	1½	38.1	1.98	50.3	1000	6.9	1.08	1.61
20024154	2	50.8	2.55	64.8	1000	6.9	1.57	2.34

Air & Multipurpose

General Purpose
 Heavy Duty
 Push-on

Chemical Transfer

Cleaning Equipment

Food Transfer Washdown

Marine

Material Handling Abrasives Bulk Transfer Cement & Concrete

Mining

Petroleum Aircraft Fueling Dispensing Dock Transfer

Spray

Steam

Vacuum

LPG Delivery

Water Discharge Suction & Discharge Washdown

Welding

Coupling Systems

Equipment

Appendix

Brigade™ Mine



Air & Multipurpose

General Purpose
Heavy Duty
Push-on

Chemical Transfer

Cleaning Equipment

Food
Transfer
Washdown

Marine

Material Handling
Abrasives
Bulk Transfer
Cement & Concrete

Mining

Petroleum
Aircraft Fueling
Dispensing
Dock
Transfer

Spray

Steam

Vacuum

LPG Delivery

Water
Discharge
Suction & Discharge
Washdown

Welding

Coupling Systems

Equipment

Appendix



Product Specifications

Application

For use as a mine fire protection hose in underground mines.

Construction Tube

Black fire-resistant Pliovic®

Cover

Orange fire-resistant Pliovic®

Reinforcement

Spiral synthetic yarn

Temperature Range

-10°F to 150°F (-23°C to 66°C)

Packaging

1½" - 500' continuous one piece, coiled and banded
2" - 400' continuous one piece, coiled and banded
2½" - 300' continuous one piece, coiled and banded

Branding (Spiral)

Example: Continental ContiTech Brigade™ Mine Flame-Resistant, USMSHA No. 2G14. 2" (52.6mm) 150 psi (1.03 MPa). Made in U.S.A.

Couplings

Contact fitting manufacturer for proper fitting recommendation and coupling procedure.

Order Codes

537-506 (150 psi)
537-508 (200 psi)

Brigade™ Mine

SAP #	ID		Nom. OD		Max. WP		Weight	
	in.	mm	in.	mm	psi	MPa	lb./ft.	kg/m
20012419	1½	38.1	1.75	44.5	150	1.03	0.23	0.34
20012427	2	50.8	2.27	57.7	150	1.03	0.34	0.51
20012429	2½	63.5	2.83	71.9	150	1.03	0.51	0.76
20012456	1½	38.1	1.72	43.7	200	1.38	0.25	0.37
20012461	2	50.8	2.29	58.2	200	1.38	0.36	0.54
20012463	2½	63.5	2.68	68.1	200	1.38	0.51	0.76

Flextra® Rock Dust



Product Specifications

Application

For handling rock dust operations in underground mines.

Construction Tube

Black ChemiTuf® synthetic rubber (static dissipating/static conductive)

Cover

Yellow Chemivic™ synthetic rubber, flame-resistant (MSHA) (wrapped impression)

Reinforcement

Spiral-plied synthetic fabric with wire helix

Temperature Range

-25°F to 200°F (-32°C to 93°C)

Packaging

50' lengths, coiled and polywrapped

Branding (Spiral)

Example: Continental ContiTech Rock Dust Flame-Resistant MSHA IC 11/7

Couplings

Contact fitting manufacturer for proper fitting recommendation and coupling procedure. Soft-cuffed ends available upon special request.

Order Codes

549-668

Flextra® Rock Dust

SAP #	ID		Nom. OD		Max. WP		Bend Radius		Vacuum HG		Weight	
	in.	mm	in.	mm	psi	MPa	in.	mm	in.	mm	lb./ft.	kg/m
20020003	1¼	31.8	1.59	40.5	100	0.69	6	152	29	737	0.48	0.72
20020005	1½	38.1	1.85	46.9	100	0.69	6	152	29	737	0.60	0.89
20020009	2	50.8	2.37	60.3	100	0.69	8	203	29	737	0.80	1.19
20020011	2½	63.5	2.89	73.3	100	0.69	10	254	29	737	1.06	1.58
20020012	3	76.2	3.35	85.1	50	0.34	12	305	29	737	1.20	1.79
20020013	4	101.6	4.41	111.9	50	0.34	16	406	29	737	1.71	2.55

Air & Multipurpose

General Purpose
Heavy Duty
Push-on

Chemical Transfer

Cleaning Equipment

Food

Transfer
Washdown

Marine

Material Handling

Abrasives
Bulk Transfer
Cement & Concrete

Mining

Petroleum

Aircraft Fueling
Dispensing
Dock
Transfer

Spray

Steam

Vacuum

LPG Delivery

Water

Discharge
Suction & Discharge
Washdown

Welding

Coupling Systems

Equipment

Appendix

M&P Mine Conduit



Air & Multipurpose

General Purpose
Heavy Duty
Push-on

Chemical Transfer

Cleaning Equipment

Food
Transfer
Washdown

Marine

Material Handling
Abrasives
Bulk Transfer
Cement & Concrete

Mining

Petroleum
Aircraft Fueling
Dispensing
Dock
Transfer

Spray

Steam

Vacuum

LPG Delivery

Water
Discharge
Suction & Discharge
Washdown

Welding

Coupling Systems

Equipment

Appendix



Product Specifications

Application

A fabric-reinforced conduit hose for use as an electrical cable cover in underground mine service.

Construction Tube

Black flame-resistant synthetic

Cover

Black flame-resistant synthetic (smooth cover)

Reinforcement

Spiral synthetic yarn

Temperature Range

-20°F to 200°F (-29°C to 93°C)

Packaging

Stocked in 50' pieces per box

Branding

Example: 3/4" (19.1mm) Mine Conduit. Made in U.S.A. Continental ContiTech. US MSHA #2G-14-7X

Couplings

Contact fitting manufacturer for proper fitting recommendation and coupling procedure.

Order Codes

569-045

M&P Mine Conduit

SAP #	ID		Nom. OD		Weight	
	in.	mm	in.	mm	lb./ft.	kg/m
20026402	1/2	12.7	0.94	23.9	0.29	0.43
20026405	5/8	15.9	1.06	26.9	0.35	0.52
20026409	3/4	19.1	1.19	30.2	0.39	0.58
20026412	7/8	22.2	1.32	33.5	0.45	0.67
20026415	1	25.4	1.43	36.3	0.46	0.68
20026417	1 1/8	28.6	1.56	39.6	0.60	0.89
20026419	1 1/4	31.8	1.69	42.9	0.62	0.92
20026421	1 3/8	34.9	1.82	46.2	0.71	1.06
20026423	1 1/2	38.1	1.95	49.5	0.75	1.12

Plicord® Ammonium Nitrate Pellet



Product Specifications

Application

For pellet transfer in blasting hole loading.

Construction Tube

Black Nitrile synthetic rubber (static dissipating/
static conductive)

Cover

Black Nitrile synthetic rubber (static dissipating/
static conductive)

Reinforcement

Spiral-plied synthetic fabric

Temperature Range

-25°F to 200°F (-32°C to 93°C)

Packaging

100' lengths, coiled and polywrapped

Branding (Spiral)

Example: Continental ContiTech Ammonium Nitrate Pellet
100 psi

Couplings

Contact fitting manufacturer for proper fitting
recommendation and coupling procedure.

Order Codes

549-232

Plicord® Ammonium Nitrate Pellet

SAP #	ID		Nom. OD		Max. WP		Weight	
	in.	mm	in.	mm	psi	MPa	lb./ft.	kg/m
20019417	3/4	19.1	1.17	29.7	100	0.69	0.33	0.49
20019420	1	25.4	1.42	36.1	100	0.69	0.34	0.51
20019422	1½	38.1	1.92	48.8	100	0.69	0.59	0.88
20105656	2	50.8	2.49	63.3	100	0.69	0.76	1.13
20133606	2½	63.5	2.94	74.7	100	0.69	0.90	1.34
20032691	3	76.2	3.42	86.9	100	0.69	1.10	1.64

Air & Multipurpose

General Purpose
Heavy Duty
Push-on

Chemical Transfer

Cleaning Equipment

Food

Transfer
Washdown

Marine

Material Handling

Abrasives
Bulk Transfer
Cement & Concrete

Mining

Petroleum

Aircraft Fueling
Dispensing
Dock
Transfer

Spray

Steam

Vacuum

LPG Delivery

Water

Discharge
Suction & Discharge
Washdown

Welding

Coupling Systems

Equipment

Appendix

Plicord® Ammonium Nitrate HD



Air & Multipurpose

General Purpose
Heavy Duty
Push-on

Chemical Transfer

Cleaning Equipment

Food
Transfer
Washdown

Marine

Material Handling
Abrasives
Bulk Transfer
Cement & Concrete

Mining

Petroleum
Aircraft Fueling
Dispensing
Dock
Transfer

Spray

Steam

Vacuum

LPG Delivery

Water
Discharge
Suction & Discharge
Washdown

Welding

Coupling Systems

Equipment

Appendix

Product Specifications

Application

A heavy duty hose for pellet transfer in blasting hole loading. Capable of handling -25°F to 200°F (-32°C to 93°C).

Construction Tube

Black Nitrile synthetic rubber (static dissipating/ static conductive)

Cover

Black Nitrile synthetic rubber (static dissipating/ static conductive) (wrapped impression)

Recommended Fittings

Contact fitting manufacturer for proper fitting recommendation and coupling procedure

Reinforcement

Spiral-plied synthetic fabric recommendation and coupling procedure

Temperature Range

-25°F to 200°F (-32°C to 93°C)

Packaging

Coiled and polywrapped

Branding

Continuous spiral brand *HD Ammonium nitrate pellet 400 psi map WP Continental ContiTech Made in Canada.

Non-Stock/Sizes

Maximum shipping length 400'

Order Codes

549-231-0

Plicord® Ammonium Nitrate HD

SAP #	DIA	ID	OD	Weight
Black	PO	mm	mm	lb./ft
20019420	1	25.3	39.7	0.58
20019422	1½	38.0	52.4	0.81
20118678	2	51.2	71.6	1.56
20135894	2½	63.7	81.7	1.62
20032691	3	76.1	92.9	1.76

Plicord® Mine Conduit



Product Specifications

Application

A fabric-reinforced hose for use as an electrical cable cover in underground mines. Meets MSHA standards for flame-resistant cover.

Construction Tube

Black Wingprene® synthetic rubber

Cover

Black Wingprene® synthetic rubber, flame-resistant (wrapped impression)

Reinforcement

Spiral-plied synthetic fabric

Temperature Range

-40°F to 200°F (-40°C to 93°C)

Packaging

50' lengths, coiled and polywrapped

Branding (Spiral)

Example: Continental ContiTech Mine Conduit Hose, Flame-Resistant, USMSHA, #2G-14/15

Couplings

Contact fitting manufacturer for proper fitting recommendation and coupling procedure.

Order Codes

549-039 (black cover)

549-035 (yellow cover)

Plicord® Mine Conduit

SAP #	ID		Nom. OD		Weight		
	Black	Yellow	in.	mm	in.	mm	lb./ft.
20019080	20019068	1/2	12.7	0.94	23.9	0.30	0.45
20019082	20019070	5/8	15.9	1.06	26.9	0.35	0.52
20019084	20019071	3/4	19.1	1.18	30.0	0.40	0.60
20019087	20019072	7/8	22.2	1.30	33.0	0.45	0.67
20019089	20019073	1	25.4	1.43	36.3	0.50	0.74
20019091	20019075	1 1/8	28.6	1.58	40.1	0.56	0.83
20019093	20045963	1 1/4	31.8	1.69	42.9	0.61	0.91
20019095	20031917	1 3/8	34.9	1.81	46.0	0.66	0.98
20019096	20029879	1 1/2	38.1	1.93	49.0	0.71	1.06
20019099	20031918	1 3/4	44.5	2.21	56.1	0.82	1.22
20019102	20019076	2	50.8	2.42	61.5	0.87	1.29
20019107		2 1/4	57.2	2.67	67.9	0.97	1.43
20019108		2 3/8	60.3	2.80	71.0	1.02	1.52
20019109	20029631	2 1/2	63.5	2.92	74.2	1.06	1.58
20019112		3	76.2	3.41	86.5	1.26	1.86
20019115		4	101.6	4.44	112.7	1.66	2.45

Air & Multipurpose

General Purpose
Heavy Duty
Push-on

Chemical Transfer

Cleaning Equipment

Food
Transfer
Washdown

Marine

Material Handling
Abrasives
Bulk Transfer
Cement & Concrete

Mining

Petroleum
Aircraft Fueling
Dispensing
Dock
Transfer

Spray

Steam

Vacuum

LPG Delivery

Water
Discharge
Suction & Discharge
Washdown

Welding

Coupling Systems

Equipment

Appendix

SpiraFlex® Cable Guard



Air & Multipurpose

General Purpose
Heavy Duty
Push-on

Chemical Transfer

Cleaning Equipment

Food
Transfer
Washdown

Marine

Material Handling
Abrasives
Bulk Transfer
Cement & Concrete

Mining

Petroleum
Aircraft Fueling
Dispensing
Dock
Transfer

Spray

Steam

Vacuum

LPG Delivery

Water
Discharge
Suction & Discharge
Washdown

Welding

Coupling Systems

Equipment

Appendix

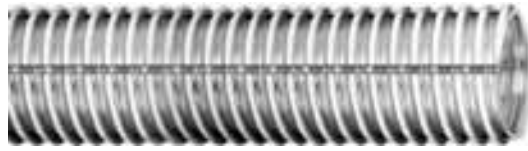

Product Specifications

Application

For use as a protective cover for supply lines.
Flame-resistant MSHA approved.

Construction Tube

Clear Pliovic® corrugated for flexibility, MSHA

Helix

Clear Pliovic® corrugated for flexibility, MSHA

Temperature Range

0°F to 150°F (-18°C to 66°C)

Packaging

Continuous one piece, coiled and polywrapped, available in 50' or 100' lengths, available preslit longitudinally for easy installation.

Branding

Example: Cable Guard, USMSHA IC-11/12. Made in U.S.A.
Continental ContiTech

Order Codes

586-438

SpiraFlex® Cable Guard

SAP #	ID		Nom. OD		Bend Radius		Weight	
	Clear	in.	mm	in.	mm	psi	MPa	lb./ft.
20013419	2	50.8	2.28	57.9	3	76	0.34	0.51
20013425	3	76.2	3.37	85.6	6	152	0.52	0.77
20013431	4	101.6	4.44	112.8	9	229	0.75	1.12

SpiraFlex® Rock Dust



Product Specifications

Application

Rock Dust hose is a lightweight, flexible alternative to the rubber hose for handling rock dusting in underground coal mines.

Construction Tube

Green Pliovic®, meets MSHA standards USMSHA

Cover

Green Pliovic®, meets MSHA standards USMSHA

Reinforcement

Rigid white Pliovic® PVC helix

Temperature Range

0°F to 158°F (-18°C to 70°C)

Packaging

100' lengths, coiled and polywrapped

Branding

Example: Rock Dust USMSHA 2G-1C-14C/17. Made in U.S.A. Continental ContiTech

Couplings

Contact fitting manufacturer for proper fitting recommendation and coupling procedure.

Non-Stock/Sizes

Static wire available, contact Customer Service.

Order Codes

586-426 (corrugated cover)

586-427 (smooth cover with static wire, not available in 4")

SpiraFlex® Rock Dust

SAP #	Smooth cover w/ static wire	ID		Nom. OD		Max. WP		Bend Radius		Vacuum HG		Weight	
		in.	mm	in.	mm	psi	MPa	in.	mm	in.	mm	lb./ft.	kg/m
20013351	20766499	1½	38.1	1.75	44.5	44	0.30	4	97	29	737	0.28	0.42
20013354	20013361	2	50.8	2.35	59.7	30	0.21	6	140	29	737	0.61	0.91
20013356	20013363	2½	63.5	2.87	72.9	30	0.21	7	178	29	737	0.61	0.91
20013358	20013365	3	76.2	3.40	86.4	30	0.21	8	203	29	737	0.77	1.15
20013359	20645908	4	101.6	4.45	113.0	27	0.19	14	356	15	381	0.95	1.41

Air & Multipurpose

General Purpose
Heavy Duty
Push-on

Chemical Transfer

Cleaning Equipment

Food
Transfer
Washdown

Marine

Material Handling
Abrasives
Bulk Transfer
Cement & Concrete

Mining

Petroleum
Aircraft Fueling
Dispensing
Dock
Transfer

Spray

Steam

Vacuum

LPG Delivery

Water
Discharge
Suction & Discharge
Washdown

Welding

Coupling Systems

Equipment

Appendix

Aircraft Fueling



Air & Multipurpose

- General Purpose
- Heavy Duty
- Push-on

Chemical Transfer

Cleaning Equipment

Food

- Transfer
- Washdown

Marine

Material Handling

- Abrasives
- Bulk Transfer
- Cement & Concrete

Mining

Petroleum

- Aircraft Fueling
- Dispensing
- Dock
- Transfer

Spray

Steam

Vacuum

LPG Delivery

Water

- Discharge
- Suction & Discharge
- Washdown

Welding

Coupling Systems

Equipment

Appendix

	Page	API 1529	NFPA	EN 1361	Static Dissipating Cover
Advantage	161	Yes	Yes		Yes
Deadman Aircraft Refueling	162				
Jet Ranger	160	Yes	Yes	Yes	Yes
Platinum JAC Riser	158	Yes		Yes	Yes
Refueling Sensing	163				
Wingcraft	159	Yes	Yes		Yes

Platinum JAC Riser Hose



Designed for aircraft refuelers equipped with moveable service platforms to act as a flexible connections between the platform and the refueling truck.

- » In a flex test of repetitive bend cycles, the leading competitor's JAC Riser product broke down at 63,600 cycles, which resulted in tube and ply separation, loss of electrical conductivity and overall kinking.
- » After 124,000 cycles on the same test, the Platinum JAC Riser had no tube separation, maintained its electrical conductivity and experienced no kinking. The test was stopped at 124,000 cycles and the integrity of the hose was still intact.

Product Specifications

Application

Commercial and private aircraft fueling/defueling of avgas jet fuel

Construction Tube

Black Nitrile synthetic rubber

Cover

Black Wingprene® (ORS) static dissipating/static conductive synthetic rubber

Reinforcement

Spiral-plied synthetic fabric

Temperature Range

-35°F to 200°F (-37°C to 93°C)

Packaging

Coiled and polywrapped.

Branding (Spiral)

Example: Continental ContiTech Platinum JAC RISER Aircraft fueling/Defueling Hose, NFPA 407 EI1529/2014, ISO1825: 2010, Type E, Grade 2, 2000 kPa (300 psi) MAX WP

Order Codes

543-244

Platinum JAC Riser Hose

SAP #	ID		Max. WP		Weight	
	in.	mm	psi	MPa	lb./ft.	kg/m
20683391	2	50.8	300	2.07	1.43	2.13
20683393	3	76.2	300	2.07	2.02	3.01
20672228	4	101.6	300	2.07	2.89	4.3

Air & Multipurpose

General Purpose
Heavy Duty
Push-on

Chemical Transfer

Cleaning Equipment

Food
Transfer
Washdown

Marine

Material Handling

Abrasives
Bulk Transfer
Cement & Concrete

Mining

Petroleum
Aircraft Fueling
Dispensing
Dock
Transfer

Spray

Steam

Vacuum

LPG Delivery

Water
Discharge
Suction & Discharge
Washdown

Welding

Coupling Systems

Equipment

Appendix

Wingcraft™



Air & Multipurpose

- General Purpose
- Heavy Duty
- Push-on

Chemical Transfer

Cleaning Equipment

- Food**
- Transfer
- Washdown

Marine

- Material Handling**
- Abrasives
- Bulk Transfer
- Cement & Concrete

Mining

- Petroleum**
- Aircraft Fueling
- Dispensing
- Dock
- Transfer

Spray

Steam

Vacuum

LPG Delivery

- Water**
- Discharge
- Suction & Discharge
- Washdown

Welding

Coupling Systems

Equipment

Appendix

Product Specifications

Application

For fueling or defueling* commercial and private aircraft. It handles jet fuel and the higher aromatic aviation gasolines. Its high working pressure permits use in fuel cart hydrant service. Hose meets API Bulletin 1529-6th edition, 2005 and N.F.P.A. Bulletin #407 (2007 revision).

Construction Tube

Black Nitrile synthetic rubber

Cover

Black Wingprene® (ORS) static dissipating/static conductive synthetic rubber

Reinforcement

Spiral-plied synthetic fabric

Temperature Range

-35°F to 200°F (-37°C to 93°C)

Packaging

Cut lengths, coiled and polywrapped

Branding

Example: Continental ContiTech Wingcraft™ Aircraft Fueling NFPA407, EI 15291/2014 Type C, Grade 2, 2", 2000 kPa (300 psi) MAX WP

Couplings

Contact fitting manufacturer for proper fitting recommendation and coupling procedures.

Non-Stock/Sizes

Custom lengths and fitting configurations available.

Order Codes

- 543-738 (1" to 3")
- 541-738 (4")

Wingcraft™

SAP #	ID	Nom. OD		Max. WP		Weight		
		in.	mm	in.	mm	lb./ft.	kg/m	
20018117	1	25.4	1.58	40.1	300	2.07	0.63	0.94
20018142	1¼	31.8	1.89	48.0	300	2.07	0.84	1.25
20016730	1½	38.1	2.13	54.1	300	2.07	0.96	1.43
20016784	2	50.8	2.72	69.1	300	2.07	1.43	2.13
20016778	2½	63.5	3.22	81.8	300	2.07	1.72	2.56
20190324	3	76.2	3.70	94.0	300	2.07	2.02	3.01
20016776	4	101.6	4.80	121.9	300	2.07	2.89	4.30

Note: Bulk hose and factory assemblies are hydrostatic tested to 600 psi and certified.

*Gravity defueling only

Jet Ranger™



Product Specifications

Application

Used in the fueling and defueling* of commercial and private aircraft. Resistant to jet fuel and higher aromatic aviation gasolines. Also for use on hydrant service. Meets both API 1529-6th edition, 2005 and European Standard BS EN 1361; 2004.

Construction Tube

Black Nitrile synthetic rubber

Cover

Black Wingprene® (ORS) static dissipating/static conductive synthetic rubber (wrapped finish)

Reinforcement

Spiral-plied (4) synthetic fabric and one nylon breaker

Temperature Range

-35°F to 200°F (-37°C to 93°C)

Jet Ranger™

SAP #	ID		Nom. OD		Max. WP		Weight	
	in.	mm	in.	mm	psi	MPa	lb./ft.	kg/m
20018250	1½	38.1	2.06	52.3	300	2.07	0.86	1.28
20046710	1¾ ₃₂	50.0	2.57	65.3	300	2.07	1.14	1.70
20099968	2½	63.5	3.16	80.3	300	2.07	1.53	2.28
20018276	3	76.2	3.64	92.5	300	2.07	1.79	2.66
20016044	4	101.6	5.00	127.0	300	2.07	3.70	5.51

Note: Bulk hose is factory hydrostatic tested to 600 psi.

*Gravity defueling only.

Packaging

Coiled and polywrapped

Branding (Spiral)

Example: Continental ContiTech Jet Ranger™ ISO 1825: 2010/C/OMEGA, NFPA 407 EI1529/2014 Type C, Grade 2, 2½", 2000 kPa/20 bars/300 psi MAX WP

Couplings

Contact fitting manufacturer for proper fitting recommendation and coupling procedures.

Order Codes

543-742 (1" to 3")

541-742 (4")

Air & Multipurpose

General Purpose
Heavy Duty
Push-on

Chemical Transfer

Cleaning Equipment

Food

Transfer
Washdown

Marine

Material Handling

Abrasives
Bulk Transfer
Cement & Concrete

Mining

Petroleum

Aircraft Fueling
Dispensing
Dock
Transfer

Spray

Steam

Vacuum

LPG Delivery

Water

Discharge
Suction & Discharge
Washdown

Welding

Coupling Systems

Equipment

Appendix

Advantage™



Air & Multipurpose
 General Purpose
 Heavy Duty
 Push-on

Chemical Transfer

Cleaning Equipment

Food
 Transfer
 Washdown

Marine

Material Handling
 Abrasives
 Bulk Transfer
 Cement & Concrete

Mining

Petroleum
 Aircraft Fueling
 Dispensing
 Dock
 Transfer

Spray

Steam

Vacuum

LPG Delivery

Water
 Discharge
 Suction & Discharge
 Washdown

Welding

Coupling Systems

Equipment

Appendix

Product Specifications

Application

Advantage™ Aircraft Fueling hose is for over- and under-the-wing fueling of commercial and private aircraft. It handles jet fuel and av-gas up to 50% aromatic content.

Construction Tube

Black Nitrile synthetic rubber

Cover

Black Wingprene® (ORS) static dissipating/static conductive synthetic rubber (wrapped impression)

Reinforcement

Spiral-plied (2) synthetic fabric and one breaker

Temperature Range

-35°F to 200°F (-37°C to 93°C)

Packaging

Cut lengths, coiled and polywrapped.

Branding

Example: Continental ContiTech Advantage™ Aircraft Fueling Hose NFPA407, E115291/2014 Type C, Grade 1, 1¼", 1000 kPa (150 psi) Max. WP

Couplings

Contact fitting manufacturer for proper fitting recommendation and coupling procedures.

Non-Stock/Sizes

Custom lengths and female fitting configurations available.

Order Codes

543-429

Advantage™

SAP #	ID	Nom. OD			Max. WP		Weight	
		in.	mm	in.	mm	psi	MPa	lb./ft.
20017874	1	25.4	1.55	39.4	150	1.03	0.60	0.89
20017880	1¼	31.8	1.81	46.0	150	1.03	0.72	1.07
20017889	1½	38.1	2.11	53.6	150	1.03	0.96	1.43

Hose meets API Bulletin 1529-6th edition, 2005, Grade 1, Type C and N.F.P.A. Bulletin #407 (2001 revision).

Note: Bulk hose and factory assemblies are hydrostatic tested to 300 psi and certified.

Deadman Aircraft Refueling



Product Specifications

Application

The double-line Deadman Refueling hose is for automatic shutoff at the operator end of aircraft hydrant and truck refueling systems. Used with pneumatic closed circuit systems commonly referred to as single point pressure refueling. Deadman hose is connected to air-actuated shut-off valves, which are controlled by the refueler technician at all times during aircraft refueling operations.

Construction Tube

Nitrile synthetic rubber, RMA Class A (High Oil Resistance)

Cover

Red/Green, Green/Yellow Chemivic™ synthetic rubber, RMA Class A (High Oil Resistance)

Reinforcement

Spiral synthetic yarn

Temperature Range

-20°F to 140°F (-29°C to 60°C)

Packaging

450'-750', maximum 3 pieces, minimum 35'

Branding (Spiral)

Permanent contrasting black ink on the Red Hose only. Example: 1/4" ID. Aircraft Fueling Deadman. Made in U.S.A. Continental ContiTech

Couplings

Contact fitting manufacturer for proper fitting recommendation and coupling procedures.

Order Codes

569-601 (Red/Green)
569-692 (Green/Yellow)

Deadman Aircraft Refueling

SAP #		ID		Nom. OD		Max. WP		Weight	
Red/Green	Green/Yellow	in.	mm	in.	mm	psi	MPa	lb./ft.	kg/m
20027376	20477995	1/4	6.4	0.53	13.5	200	1.38	0.2	0.3

Air & Multipurpose

General Purpose
Heavy Duty
Push-on

Chemical Transfer

Cleaning Equipment

Food Washdown

Marine

Material Handling

Abrasives
Bulk Transfer
Cement & Concrete

Mining

Petroleum Aircraft Fueling

Dispensing
Dock
Transfer

Spray

Steam

Vacuum

LPG Delivery

Water Discharge

Suction & Discharge
Washdown

Welding

Coupling Systems

Equipment

Appendix

Refueling Sensing



Air & Multipurpose
 General Purpose
 Heavy Duty
 Push-on

Chemical Transfer

Cleaning Equipment

Food
 Transfer
 Washdown

Marine

Material Handling
 Abrasives
 Bulk Transfer
 Cement & Concrete

Mining

Petroleum
 Aircraft Fueling
 Dispensing
 Dock
 Transfer

Spray

Steam

Vacuum

LPG Delivery

Water
 Discharge
 Suction & Discharge
 Washdown

Welding

Coupling Systems

Equipment

Appendix

Product Specifications

Application

The double-line Refueling Sensing hose is for use on pressurized aircraft hydrant fueling systems common at the larger metropolitan airports. The Sensing hose operates in a system where air and fuel from the underground hydrants monitor the flow and pressure of fuel being pumped into the aircraft. The hose carries the deadman function (automatic safety shutdown) and pressure control signals from the dispensing vehicle to the hydrant pit control valve.

Construction Tube

Nitrile synthetic rubber, RMA Class A (High Oil Resistance)

Cover

Orange/Black high-quality Hysunite™ synthetic rubber

Reinforcement

Spiral synthetic yarn

Temperature Range

-20°F to 140°F (-29°C to 60°C)

Packaging

450'-750' reels, maximum 3 pieces, minimum 35'

Branding

Permanent contrasting white ink on black hose only

Couplings

Contact fitting manufacturer for proper fitting recommendation and coupling procedures.

Order Codes

(Orange/Black) 569-604

Refueling Sensing

SAP #	ID		Nom. OD		Max. WP		Weight	
	in.	mm	in.	mm	psi	MPa	lb./ft.	kg/m
20027379	3/8	9.5	0.66	16.8	200	1.38	0.28	0.42

Dispensing



	CUL and/or Page	UL Approved	Gasoline	Diesel	Biodiesel*	Ethanol**	Wire Reinforcement	Textile Reinforcement
Aggie Gas	172		Yes	Yes				Yes
BC Cold Flex	173	Yes	Yes	Yes	Yes			Yes
BC Gasoline	174	Yes	Yes	Yes	Yes			Yes
BC Marina	175	Yes	Yes	Yes	Yes			Yes
DEF Dispensing Hose	177							Yes
Flexsteel Futura Ethan-ALL	180	Yes				Yes	Yes	Yes
Flexsteel Futura	165		Yes	Yes	Yes		Yes	
Flexsteel Futura Low Perm	167		Yes	Yes	Yes		Yes	
Flexsteel Futura HVR	168		Yes	Yes	Yes		Yes	
Flexsteel Futura Vapor Assist	166	Yes	Yes				Yes	
Maxxim Premier	169	Yes	Yes				Yes	
Maxxim Premier Plus	170	Yes	Yes				Yes	
Pacer	171	Yes	Yes	Yes	Yes			Yes

*Biodiesel blends up to B20

**Ethanol up to E85

Air & Multipurpose

General Purpose
Heavy Duty
Push-on

Chemical Transfer

Cleaning Equipment

Food

Transfer
Washdown

Marine

Material Handling

Abrasives
Bulk Transfer
Cement & Concrete

Mining

Petroleum

Aircraft Fueling
Dispensing
Dock
Transfer

Spray

Steam

Vacuum

LPG Delivery

Water

Discharge
Suction & Discharge
Washdown

Welding

Coupling Systems

Equipment

Appendix

Flexsteel® Futura™



Air & Multipurpose

- General Purpose
- Heavy Duty
- Push-on

Chemical Transfer

Cleaning Equipment

- Food**
- Transfer
- Washdown

Marine

- Material Handling**
- Abrasives
- Bulk Transfer
- Cement & Concrete

Mining

- Petroleum**
- Aircraft Fueling
- Dispensing
- Dock
- Transfer

Spray

Steam

Vacuum

LPG Delivery

- Water**
- Discharge
- Suction & Discharge
- Washdown

Welding

Coupling Systems

Equipment

Appendix



Product Specifications

Application

Flexsteel® Futura™ with new Futurin™ cover resists cracking and fading, designed to dispense a wide range of fuels with extreme durability. The wire braid construction provides excellent kink resistance, low computer creep, and long service life. UL 330 and CUL approved.

Construction Tube

Nitrile synthetic rubber (ORS)

Cover

Futurin™ synthetic rubber (ORS)

Reinforcement

Wire braid

Temperature Range

-40°F to 140°F (-40°C to 60°C)

Packaging

5/8" and 3/4" - Reels or coupled lengths, 10 pieces per box
 1" - Reels or coupled lengths, 5 pieces per box

Branding

Example: Continental ContiTech 559N, Made in U.S.A. 3/4" (19mm) UL, CUL. Listed Flexsteel® Futura™

Couplings

Contact fitting manufacturer for proper fitting recommendation and coupling procedure.

Order Codes

532-327

Flexsteel® Futura™

ID		Nom. OD		Weight	
in.	mm	in.	mm	lb./ft.	kg/m
5/8	15.9	1.00	25.4	0.40	0.60
3/4	19.1	1.13	28.7	0.45	0.67
1	25.4	1.38	35.1	0.61	0.91

Flexsteel® Futura™ Vapor Assist



Product Specifications

Application

For Stage II Vacuum Assist Systems where a pump in the dispenser pulls the gasoline vapors away from the vehicle fill pipe during fueling. The wire-braid construction for the fuel hose provides excellent kink resistance, low computer creep and long service life. Flexsteel® Futura™ Vapor Assist is UL 330 approved.

Construction Tube

Nitrile synthetic rubber (ORS)

Cover

Futurin™ synthetic rubber (ORS)

Reinforcement

Braided (1) steel wire

Temperature Range

-40°F to 140°F (-40°C to 60°C)

Packaging

Coupled lengths only, 6 pieces per box

Branding

Example: 3/4" Continental ContiTech Made in U.S.A. UL Listed Flexsteel® Futura™ Vapor Assist
 Example: 7/8" Continental ContiTech Made in U.S.A. UL Listed Flexsteel® Futura™ Vapor Assist

Couplings

Available only as factory coupled assembly.

Order Codes

532-362

Flexsteel® Futura™ Vapor Assist

ID		Nom. OD		Weight	
in.	mm	in.	mm	lb./ft.	kg/m
3/4	19.1	1.13	28.7	0.45	0.67
7/8	22.2	1.25	31.8	0.49	0.73

Air & Multipurpose

General Purpose
 Heavy Duty
 Push-on

Chemical Transfer

Cleaning Equipment

Food
 Transfer
 Washdown

Marine

Material Handling
 Abrasives
 Bulk Transfer
 Cement & Concrete

Mining

Petroleum
 Aircraft Fueling
 Dispensing
 Dock
 Transfer

Spray

Steam

Vacuum

LPG Delivery

Water
 Discharge
 Suction & Discharge
 Washdown

Welding

Coupling Systems

Equipment

Appendix

New Flexsteel® Futura™ Low Perm



Air & Multipurpose

- General Purpose
- Heavy Duty
- Push-on

Chemical Transfer

Cleaning Equipment

Food

- Transfer
- Washdown

Marine

Material Handling

- Abrasives
- Bulk Transfer
- Cement & Concrete

Mining

Petroleum

- Aircraft Fueling
- Dispensing
- Dock Transfer

Spray

Steam

Vacuum

LPG Delivery

Water

- Discharge
- Suction & Discharge
- Washdown

Welding

Coupling Systems

Equipment

Appendix



The First UL-Approved Low Permeation Gasoline Dispensing Hose Available to the Market

The Flexsteel® Futura™ Low Perm dispensing hose offers superior, long-lasting service with multi-fuel capability. This hose is designed for use at filling stations to reduce permeation rates to 10 grams/m²/day and improve air quality and emissions.

- › Premium abuse-resistant cover compound with enhanced ozone resistance for service longevity
- › Meets UL330 requirements for conventional and vapor recovery
- › Meets stringent permeation requirements of less than 10 grams/m²/day

The Flexsteel® Futura™ Low Perm dispensing hose is the only low permeation gasoline hose available with the following specifications:

Product Code

532-338-024

Dimensions

Size.	ID in.	OD in.	Working Pressure
3/4	0.720-0.780"	1.115-1.165"	50 psi

Tube

Nitrile synthetic rubber with Fluorothermoplastice barrier layer

Braid

Single wire braid

Cover

Futurin™ synthetic rubber

Permeation

Meets UL330 permeation limit of 10 grams/m²/day

Branding

Listed to UL330.

3/4" Straight and Swivels available with NPT threads.

Flexsteel® Futura™ HVR



Product Specifications

Application

- › Premium abuse-resistant cover compound with enhanced ozone resistance for service longevity
- › Meets UL330, CARB, ORVR and EVR requirements
- › Factory-made assemblies with fittings designed for Healy Stage II Enhanced Vapor Recovery (EVR) Systems compatibility

Construction Tube

Nitrile synthetic rubber (ORS)

Cover

Futurin™ synthetic rubber (ORS)

Reinforcement

Braided (1) steel wire

Temperature Range

-40°F to 140°F (-40°C to 60°C)

Packaging

Coupled lengths only, 6 pieces per box

Branding

Example: 3/4" Continental ContiTech Made in U.S.A., UL Listed Flexsteel® Futura™ HVR Continental ContiTech Made in U.S.A.,

Couplings

Available only as factory coupled assembly.

Non-Stock/Sizes

For special production run minimum requirements, contact customer service

Order Codes

532-330

Flexsteel® Futura™ HVR

ID		Nom. OD		Weight	
in.	mm	in.	mm	lb./ft.	kg/m
3/4	19.1	1.13	28.7	0.45	0.67

Air & Multipurpose

General Purpose
Heavy Duty
Push-on

Chemical Transfer

Cleaning Equipment

Food

Transfer
Washdown

Marine

Material Handling

Abrasives
Bulk Transfer
Cement & Concrete

Mining

Petroleum

Aircraft Fueling
Dispensing
Dock
Transfer

Spray

Steam

Vacuum

LPG Delivery

Water

Discharge
Suction & Discharge
Washdown

Welding

Coupling Systems

Equipment

Appendix

Maxxim™ Premier



Air & Multipurpose

- General Purpose
- Heavy Duty
- Push-on

Chemical Transfer

Cleaning Equipment

Food

- Transfer
- Washdown

Marine

Material Handling

- Abrasives
- Bulk Transfer
- Cement & Concrete

Mining

Petroleum

- Aircraft Fueling
- Dispensing
- Dock
- Transfer

Spray

Steam

Vacuum

LPG Delivery

Water

- Discharge
- Suction & Discharge
- Washdown

Welding

Coupling Systems

Equipment

Appendix



Product Specifications

Application

For Stage II Balance Systems where the gasoline vapors from the fill pipe are pushed back through the outer hose. The outer vapor hose has a textile-reinforced thermoplastic layer over a wire helix. The textile-reinforced thermoplastic cover has maximum puncture resistance, stable dimensions and long service life. The wire braid construction for the fuel hose provides excellent kink resistance and low computer creep. Maxxim™ Premier hose is C.A.R.B. and UL 330 approved.

Construction Tube

Nitrile synthetic rubber (ORS)

Cover

Chemivic™ synthetic rubber (ORS), thermoplastic outer with textile reinforcement and wire helix

Reinforcement

Braided (1) steel wire

Temperature Range

-40°F to 140°F (-40°C to 60°C)

Packaging

Coupled lengths only, 6 pieces per box

Branding

Not branded

Couplings

Available only as factory coupled assembly.

Order Codes

532-365-440

Maxxim™ Premier

ID		ID-Inner Hose		Nom. OD-Inner Hose		Weight-Inner Hose	
in.	mm	in.	mm	psi	MPa	lb./ft.	kg/m
1¼	31.75	5/8	15.9	0.85	21.6	0.22	0.33

Maxxim™ Premier Plus

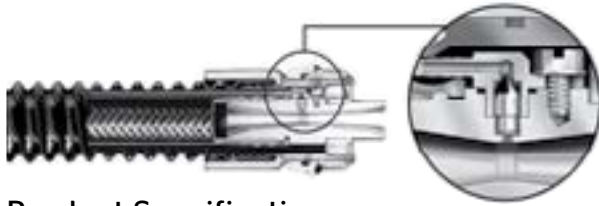

Product Specifications

Application

Maxxim™ Premier Plus incorporates a Venturi pump in the protected confines of the inner fuel hose coupling to keep the vapor path open in the outer hose. As gasoline flows through the Venturi pump, gasoline accumulating in the bottom loop of the vapor hose is collected and returned to the fuel hose. C.A.R.B., EVR and UL 330 approved.

Construction Tube

Nitrile synthetic rubber (ORS)

Cover

Chemivic™ synthetic rubber (ORS), thermoplastic outer with textile reinforcement and wire helix.

Reinforcement

Braided (1) steel wire

Temperature Range

-40°F to 140°F (-40°C to 60°C)

Packaging

Coupled lengths only, 6 pieces per box

Branding

Not branded

Couplings

Available only as factory coupled assembly.

Order Codes

532-365-441
532-365-641 (EVR)

Maxxim™ Premier Plus

ID		ID-Inner Hose		Nom. OD-Inner Hose		Weight-Inner Hose	
in.	mm	in.	mm	psi	MPa	lb./ft.	kg/m
1¼	31.75	5/8	15.9	0.85	21.6	0.22	0.33

Air & Multipurpose

General Purpose
Heavy Duty
Push-on

Chemical Transfer

Cleaning Equipment

Food
Transfer
Washdown

Marine

Material Handling
Abrasives
Bulk Transfer
Cement & Concrete

Mining

Petroleum
Aircraft Fueling
Dispensing
Dock
Transfer

Spray

Steam

Vacuum

LPG Delivery

Water
Discharge
Suction & Discharge
Washdown

Welding

Coupling Systems

Equipment

Appendix

Pacer™



Air & Multipurpose

- General Purpose
- Heavy Duty
- Push-on

Chemical Transfer

Cleaning Equipment

- Food**
- Transfer
- Washdown

Marine

Material Handling

- Abrasives
- Bulk Transfer
- Cement & Concrete

Mining

Petroleum

- Aircraft Fueling
- Dispensing
- Dock
- Transfer

Spray

Steam

Vacuum

LPG Delivery

- Water**
- Discharge
- Suction & Discharge
- Washdown

Welding

Coupling Systems

Equipment

Appendix

Product Specifications

Application

For all types of gasoline dispensing applications where flexibility and a lightweight hose is desired. Pacer™ is designed with a spiral textile reinforcement. UL 330 and CUL approved.

Construction Tube

Nitrile synthetic rubber (ORS)

Cover

Chemivic™ synthetic rubber (ORS)

Reinforcement

Spiral synthetic yarn with static wire

Temperature Range

-40°F to 140°F (-40°C to 60°C)

Packaging

Reels or coupled lengths

Branding

Example: 3/4" Pacer™ Continental ContiTech

Couplings

Contact fitting manufacturer for proper fitting recommendation and coupling procedure.

Order Codes

- 595-015 (bulk)
- 595-017 (factory coupled assemblies)

Pacer™

ID		Nom. OD		Weight	
in.	mm	in.	mm	lb./ft.	kg/m
5/8	15.9	0.98	24.9	0.28	0.42
3/4	19.1	1.15	29.2	0.37	0.55
1	25.4	1.50	38.1	0.60	0.89

Aggie Gas™



Product Specifications

Application

A multi-use type hose for dispensing gasoline, grease, kerosene, and petroleum oils from farm and barrel type pumps. It is for agricultural, construction and industrial service where UL approval is not required.

Construction Tube

Nitrile synthetic rubber (ORS)

Cover

Black or red Chemivic™ synthetic rubber (ORS)

Reinforcement

Spiral synthetic yarn

Temperature Range

-30°F to 140°F (-34°C to 60°C)

Packaging

Reels or coupled lengths, 5 pieces per box

Branding

Example: Aggie Gas™ 3/4" (19.1mm) Static Bonded Continental ContiTech

Couplings

Contact fitting manufacturer for proper fitting recommendation and coupling procedure.

Aggie Gas™ - No Static Wire

Order Codes: 595-001 (no static wire) (black) 595-002 (no static wire) (red)
 3/4" SAP: 20028755 (8'), 20028757 (10'), 20028759 (12'), 20028761 (14')
 1" SAP: 20028755 (8'), 20028742 (10'), 20028744 (12'), 20028746 (14')

ID		Nom. OD		Weight	
in.	mm	in.	mm	lb./ft.	kg/m
3/4	19.1	1.11	28.2	0.27	0.40
1	25.4	1.40	35.6	0.52	0.77

Aggie Gas™ - With Static Wire

Order Codes: 595-026 (with static wire - bulk) (black) 595-028 (with static wire) - factory coupled assemblies) (black)
 3/4" SAP: 20352464 (8'), 20352465 (10'), 20352504 (12'), 20352507 (14')
 1" SAP: 20352551 (8'), 20352552 (10'), 20352535 (12')

ID		Nom. OD		Weight	
in.	mm	in.	mm	lb./ft.	kg/m
3/4	19.1	1.11	28.2	0.27	0.40
1	25.4	1.40	35.6	0.52	0.77

Air & Multipurpose

General Purpose
 Heavy Duty
 Push-on

Chemical Transfer

Cleaning Equipment

Food
 Transfer
 Washdown

Marine

Material Handling

Abrasives
 Bulk Transfer
 Cement & Concrete

Mining

Petroleum
 Aircraft Fueling
 Dispensing
 Dock
 Transfer

Spray

Steam

Vacuum

LPG Delivery

Water
 Discharge
 Suction & Discharge
 Washdown

Welding

Coupling Systems

Equipment

Appendix

BC Cold Flex



Air & Multipurpose
 General Purpose
 Heavy Duty
 Push-on



Chemical Transfer

Cleaning Equipment

Food
 Transfer
 Washdown

Marine

Material Handling
 Abrasives
 Bulk Transfer
 Cement & Concrete

Mining

Petroleum
 Aircraft Fueling
 Dispensing
 Dock
 Transfer

Spray

Steam

Vacuum

LPG Delivery

Water
 Discharge
 Suction & Discharge
 Washdown

Welding

Coupling Systems

Equipment

Appendix

Product Specifications

Application

A premium gas pump hose for use in extremely cold environments. Remains flexible where temperatures of -65°F (-54°C) are encountered. UL 330 and CUL approved. The only UL approved cold temperature

Construction Tube

Black, low-temp synthetic rubber

Cover

Black, low-temp synthetic rubber (wrapped finish)

Reinforcement

Braided synthetic yarn with antistatic wire

Temperature Range

-65°F to 140°F (-54°C to 60°C)

Packaging

500' reels +/- 50'; minimum 50'; maximum 3 pieces
 Premade assemblies available

Branding

Example: Continental ContiTech 559 N, Made in U.S.A. 3/4" (19mm) UL, CUL Listed BC Cold Flex Gasoline Hose

Couplings

Use Continental ContiTech Fuelgrip Fittings for proper fitting recommendation and coupling procedure.

Order Codes

532-395

BC Cold Flex

SAP #	ID		Nom. OD		Weight	
	in.	mm	in.	mm	lb./ft.	kg/m
20195843	3/4	19.1	1.13	28.7	0.32	0.48
20195844	1	25.4	1.50	38.1	0.57	0.85

BC Gasoline



Product Specifications

Application

For all types of dispensing pump applications where flexibility and lightweight are desired. BC is available with one or two textile braids. UL 330 and CUL approved.

Construction Tube

Nitrile synthetic rubber (ORS)

Cover

Black Chemivic™ synthetic rubber (ORS)

Reinforcement

Braided synthetic yarn with static wire, available in one or two braid

Temperature Range

-40°F to 140°F (-40°C to 60°C)

Packaging

5/8" and 3/4" - Reels or coupled lengths, 10 pieces per box
 1" - Reels or coupled lengths, 5 pieces per box

Branding

Example: 1" (25.4mm) 2BD. CUL, UL Listed style BC Gasoline Continental ContiTech 559N. Made in U.S.A.

Couplings

Contact fitting manufacturer for proper fitting recommendation and coupling procedure.

Order Codes

532-012 (1 braid)
 532-013 (2 braid)
 532-314 (Blue)
 532-313 (Red)
 532-309 (Green)

BC Gasoline (1 Braid)

SAP #	ID		Nom. OD		Weight	
	in.	mm	in.	mm	lb./ft.	kg/m
20014734	5/8	15.9	1.00	25.4	0.28	0.42
20014738	3/4	19.1	1.13	28.7	0.32	0.48

BC Gasoline (2 Braid)

SAP #	ID		Nom. OD		Weight	
	in.	mm	in.	mm	lb./ft.	kg/m
20021581	5/8	15.9	1.00	25.4	0.24	0.36
20021585	3/4	19.1	1.19	30.2	0.37	0.55
20021591	1	25.4	1.50	38.1	0.55	0.82

Air & Multipurpose

General Purpose
 Heavy Duty
 Push-on

Chemical Transfer

Cleaning Equipment

Food
 Transfer
 Washdown

Marine

Material Handling
 Abrasives
 Bulk Transfer
 Cement & Concrete

Mining

Petroleum
 Aircraft Fueling
 Dispensing
 Dock
 Transfer

Spray

Steam

Vacuum

LPG Delivery

Water
 Discharge
 Suction & Discharge
 Washdown

Welding

Coupling Systems

Equipment

Appendix

BC Marina



Air & Multipurpose

- General Purpose
- Heavy Duty
- Push-on

Chemical Transfer

Cleaning Equipment

- Food**
- Transfer
- Washdown

Marine

Material Handling

- Abrasives
- Bulk Transfer
- Cement & Concrete

Mining

Petroleum

- Aircraft Fueling
- Dispensing
- Dock
- Transfer

Spray

Steam

Vacuum

LPG Delivery

Water

- Discharge
- Suction & Discharge
- Washdown

Welding

Coupling Systems

Equipment

Appendix



Product Specifications

Application

For dispensing gasoline to pleasure craft and commercial boats at fresh and salt water marinas. UL 330 and CUL approved.

Construction Tube

Nitrile synthetic rubber (ORS)

Cover

Green Chemivic™ synthetic rubber (ORS) (nonmarking)

Reinforcement

Braided (2) synthetic yarn with static wire

Temperature Range

-40°F to 140°F (-40°C to 60°C)

Packaging

Reels or coupled lengths

Branding

Example: 1" (25.4mm) 2BD. UL Listed Marina Gasoline Continental ContiTech 559N. Made in U.S.A.

Couplings

Contact fitting manufacturer for proper fitting recommendation and coupling procedure.

Order Codes

532-293

BC Marina

SAP#	ID		Nom. OD		Weight		
	Green	in.	mm	in.	mm	lb./ft.	kg/m
20021819	3/4		19.1	1.19	30.2	0.38	0.57
20021826	1		25.4	1.50	38.1	0.57	0.85

Flexsteel® Futura™ Ethan-ALL™ Dispensing Hose Assembly



Product Specifications

Application

Flexsteel® Futura™ Ethan-ALL™ dispensing hose assembly is UL certified for use in ethanol dispensing applications up to E85. This new assembly provides the quality Futurin™ cover with its superior ozone resistance along with a new premium layline. The tube construction meets the E25/E85 compatibility test requirements of UL 87A.

The Flexsteel® Futura™ Ethan-ALL™ dispensing hose assembly uses the Continental ContiTech proprietary Fuel Grip™ fitting with a premium nickel coating to ensure corrosion is limited.

Construction Tube

Nitrile synthetic rubber

Cover

Futurin™ synthetic rubber

Reinforcement

Wire braid

Temperature Range

-40°F to 140°F (-40°C to 60°C)

Packaging

Coupled assemblies only

Branding

Example: 3/4" (UL) Listed Continental ContiTech Flexsteel® Futura™ Ethan-ALL™ E85 559N. Made in U.S.A.

Order Codes

532-337-124

Flexsteel® Futura™ Ethan-ALL™ Dispensing Hose Assembly

ID		OD		Max. WP		Weight	
in.	mm	in.	mm	psi	MPa	lb./ft.	kg/m
3/4	19.1	1.13	28.7	50	0.34	0.46	0.69

Air & Multipurpose
General Purpose
Heavy Duty
Push-on

Chemical Transfer

Cleaning Equipment

Food
Transfer
Washdown

Marine

Material Handling
Abrasives
Bulk Transfer
Cement & Concrete

Mining

Petroleum
Aircraft Fueling
Dispensing
Dock
Transfer

Spray

Steam

Vacuum

LPG Delivery

Water
Discharge
Suction & Discharge
Washdown

Welding

Coupling Systems

Equipment

Appendix

DEF Dispensing Hose



Product Specifications

Air & Multipurpose

- General Purpose
- Heavy Duty
- Push-on

Chemical Transfer

Cleaning Equipment

- Food
- Transfer
- Washdown

Marine

- Material Handling
- Abrasives
- Bulk Transfer
- Cement & Concrete

Mining

- Petroleum**
- Aircraft Fueling
- Dispensing
- Dock
- Transfer

Spray

Steam

Vacuum

LPG Delivery

- Water
- Discharge
- Suction & Discharge
- Washdown

Welding

Coupling Systems

Equipment

Appendix

Application

Diesel Exhaust Fluid (DEF: aqueous 32.5% nitrogen solution of high-purity urea in deionized water) is a key component of selective catalytic reduction (SCR) systems, which help diesel vehicles meet stringent emission regulations effective January 1, 2010. DEF is a liquid reducing agent that reacts with engine exhaust in the presence of a catalyst to convert smog-forming nitrogen oxides (NOx) into harmless nitrogen and water vapor.

Continental ContiTech is specifically designed to convey the high-purity, aqueous urea solution DEF. Hose tube compound is specially formulated with low extraction EPDM and peroxide cured to provide superior extraction levels to significantly reduce contamination. Flexible softwall construction provides superior handling in standard dispensing and reeling applications. Static wire available for installation in Class I, Division 1 areas.

Construction Tube

Specially formulated low-extraction EPDM, peroxide cured

Cover

Specially formulated EPDM

Reinforcement

Polyester braid

Temperature Range

-40°F to 140°F (-40°C to 60°C)

Packaging

Bulk, coupled assemblies (NPT and BSPP fittings available)

Branding

Example: Continental ContiTech DEF Dispensing Hose 3/4" (19.1mm)

Order Codes

532-027

Assemblies available

DEF Dispensing Hose

Features

Specially formulated low extraction EPDM compound for tube peroxide cured

Enhanced manufacturing practices

Premium braided construction

Static wire

Meets ISO 22241 standard

Benefits

Provides superior extraction levels to significantly reduce contamination that can clog an SCR system and stop a truck

Significantly reduce contamination that can clog an SCR system and stop a truck

Reduced volumetric expansion to meet Weights and Measures system criteria

Requirement for installations in Class I, Division 1 areas as outlined in NFPA 70

Ensures desirable characteristics of AUS 32 (DEF) are met, such as quality, safety, reliability and contamination

DEF Dispensing Hose

SAP #	ID		Nom. OD		Weight		Max WP	
	in.	mm	in.	mm	lb./ft.	kg/m	psi	MPa
20554236	1/2	12.7	0.89	22.6	0.21	0.31	250	1.72
20528917	3/4	19.1	1.13	28.8	.30	0.46	250	1.72
20686517	1	25.4	1.45	36.8	0.42	0.62	250	1.72

Dock



	Page	Nitrile Tube	Flosyn Tube	Max WP	Corrugated	Temp. Range	Built-in Nipple	Swage Nipple*
Flexdock 225	179	Yes	Yes	225	Yes	-25°F to 200°F (-32°C to 93°C)	Yes	Yes
Flexdock 300	180	Yes	Yes	300	Yes	-25°F to 200°F (-32°C to 93°C)	Yes	Yes
Hot Tar & Asphalt Rough Bore	188	Yes		200		-25°F to 350°F (-32°C to 177°C)	Yes	
Hot Tar & Asphalt Smooth Bore	188	Yes		200		-25°F to 350°F (-32°C to 177°C)	Yes	
Smooth Bore Dock 200	181	Yes	Yes	200		-25°F to 200°F (-32°C to 93°C)	Yes	Yes
Smooth Bore Dock 300	182	Yes	Yes	300		-25°F to 200°F (-32°C to 93°C)	Yes	Yes
Tanker Barge Discharge	183	Yes	Yes	200		-25°F to 220°F (-32°C to 105°C)	Yes	Yes
Oil Rig Service with Integral Positive Float System	189-190			290		-22°F to 180°F (-30°C to 82°C)		
Plicord Dock Hose	187			225		-25°F to 180°F (-32°C to 82°C)		
Plicord HW Dry Cement/Barytes	185			150		-22°F to 180°F (-30°C to 82°C)		
Plicord SW Dry Cement/Barytes	186			150		-22°F to 180°F (-30°C to 82°C)		
RB Dock Asphalt & Bitumen EN 13482	191			225		-30°F to 392°F (-37°C to 200°C)	Yes	
SB Dock Asphalt & Bitumen EN 13482	192			225		-30°F to 392°F (-37°C to 200°C)	Yes	
Vapor Recovery Dock	184	Yes	Yes	25	Yes	-25°F to 200°F (-32°C to 93°C)	Yes	Yes

Up to 10" ID

Air & Multipurpose
General Purpose
Heavy Duty
Push-on

Chemical Transfer

Cleaning Equipment

Food
Transfer
Washdown

Marine

Material Handling
Abrasives
Bulk Transfer
Cement & Concrete

Mining

Petroleum
Aircraft Fueling
Dispensing
Dock
Transfer

Spray

Steam

Vacuum

LPG Delivery

Water
Discharge
Suction & Discharge
Washdown

Welding

Coupling Systems

Equipment

Appendix

Flexdock® 225



Air & Multipurpose

- General Purpose
- Heavy Duty
- Push-on

Chemical Transfer

Cleaning Equipment

- Food
- Transfer
- Washdown

Marine

- Material Handling
- Abrasives
- Bulk Transfer
- Cement & Concrete

Mining

- Petroleum**
- Aircraft Fueling
- Dispensing
- Dock
- Transfer

Spray

Steam

Vacuum

LPG Delivery

- Water**
- Discharge
- Suction & Discharge
- Washdown

Welding

Coupling Systems

Equipment

Appendix

Product Specifications

Application

Built with a corrugated cover to provide flexibility in petroleum transfer service. A variety of tube compounds are available to tailor the chemical and hydrocarbon resistance of the hose to the type of material handled.

Construction Tube

Nitrile synthetic rubber for up to 50% aromatics. Also available with a Flosyn® tube for up to 100% aromatics.

Cover

Black Wingprene® synthetic cover, corrugated, wrapped finish

Reinforcement

Spiral-plied heavy-duty synthetic fabric with double wire helix

Temperature Range

-25°F to 200°F (-32°C to 93°C)

Packaging

Chloroplast heavy-duty packaging

Branding (Spiral)

Example: Continental ContiTech Flexdock® 225 psi WP Nitrile Oil Service

Couplings

Coupled with standard built-in steel nipple/150#RF50 flanges. Available in other bolt hole patterns, materials and floating flanges on request. Swage nipples are offered up to 10". Hose assembly is electrically continuous unless otherwise specified by customer.

Non-Stock/Sizes

Custom lengths available, contact Customer Service.

Order Codes

- 541-532 (Nitrile tube)
- 541-534 (Flosyn® tube)

Flexdock® 225

SAP #	ID	Nom. OD		Max. WP		Bend Radius		Vacuum HG		Weight			
		in.	mm	psi	MPa	in.	mm	in.	mm	lb./ft.	kg/m		
20346713	20424276	3	76.2	3.89	98.8	225	1.55	11	279	29	737	3.28	4.88
20655171	20054995	4	101.6	5.29	134.4	225	1.55	15	381	29	737	6.30	9.38
20032061	20054996	6	152.4	7.34	186.4	225	1.55	22	559	29	737	9.50	14.14
20476794	20129447	8	203.2	9.43	239.5	225	1.55	30	762	29	737	13.81	20.55
20098252	20139283	10	254.0	11.63	295.4	225	1.55	40	1016	29	737	20.49	30.49
20704428	20424277	12	304.8	13.72	348.5	225	1.55	60	1524	29	737	25.13	37.40

Note: Factory coupled hose manufactured according to the code of Federal Regulations Standard 33 CFR 154.500 and 33 CFR 156.170.

Flexdock® 300



Product Specifications

Application

Built with a corrugated cover to provide flexibility in petroleum transfer service. A variety of tube compounds are available to tailor the chemical and hydrocarbon resistance of the hose to the type of material handled.

Construction Tube

Nitrile synthetic rubber for up to 50% aromatics. Also available with a Flosyn® tube for up to 100% aromatics.

Cover

Black Wingprene® synthetic cover, corrugated, wrapped finish

Reinforcement

Heavy-duty synthetic fabric plies with double wire helix

Temperature Range

-25°F to 200°F (-32°C to 93°C)

Packaging

Chloroplast heavy-duty packaging

Branding (Spiral)

Example: Continental ContiTech Flexdock® 300 psi WP Nitrile Oil Service

Couplings

Coupled with standard built-in steel nipple/150#RFSO flanges. Available in other bolt hole patterns, materials and floating flanges on request. Swage nipples are offered up to 10". Hose assembly is electrically continuous unless otherwise specified by customer.

Non-Stock/Sizes

Custom lengths available, contact Customer Service.

Order Codes

541-533 (Nitrile Tube)
541-535 (Flosyn® tube)

Flexdock® 300

SAP #		ID		Nom. OD		Max. WP		Bend Radius		Vacuum HG		Weight	
Nitrile Tube	Flosyn Tube	in.	mm	in.	mm	psi	MPa	in.	mm	in.	mm	lb./ft.	kg/m
20015736	20307537	4	101.6	5.29	134.4	300	2.07	19	483	29	737	6.30	9.38
20015748	20169212	6	152.4	7.35	186.7	300	2.07	28	711	29	737	9.64	14.35
20015764	20160411	8	203.2	9.63	244.6	300	2.07	38	965	29	737	15.56	23.16
20546829		10	254.0	11.51	292.4	300	2.07	48	1219	29	737	19.73	29.36
20015774	20590479	12	305.5	13.94	353.9	300	2.07	58	1473	29	737	28.89	42.98

Note: Factory coupled hose manufactured according to the code of Federal Regulations Standard 33 CFR 154.500 and 33 CFR 156.170.

Air & Multipurpose
General Purpose
Heavy Duty
Push-on

Chemical Transfer

Cleaning Equipment

Food
Transfer
Washdown

Marine

Material Handling
Abrasives
Bulk Transfer
Cement & Concrete

Mining

Petroleum
Aircraft Fueling
Dispensing
Dock
Transfer

Spray

Steam

Vacuum

LPG Delivery

Water
Discharge
Suction & Discharge
Washdown

Welding

Coupling Systems

Equipment

Appendix

Smooth Bore Dock 200



Air & Multipurpose

- General Purpose
- Heavy Duty
- Push-on

Chemical Transfer

Cleaning Equipment

Food
Transfer
Washdown

Marine

Material Handling
Abrasives
Bulk Transfer
Cement & Concrete

Mining

Petroleum
Aircraft Fueling
Dispensing
Dock
Transfer

Spray

Steam

Vacuum

LPG Delivery

Water
Discharge
Suction & Discharge
Washdown

Welding

Coupling Systems

Equipment

Appendix

Product Specifications

Application

For the transfer of petroleum-based products between docks and ships under all types of service conditions. It is available in a number of tube compounds to tailor the fluid handling capabilities to a wide variety of petroleum and chemical compositions.

Construction Tube

Nitrile synthetic rubber for up to 50% aromatics. Also available with a Flosyn® tube for up to 100% aromatics.

Cover

Black Chemivic™ (smooth cover, wrap finish)

Reinforcement

Spiral plied synthetic fabric with wire helix

Temperature Range

-25°F to 200°F (-32°C to 93°C)

Packaging

Chloroplast heavy-duty packaging

Branding (Spiral)

Example: Continental ContiTech SB Dock oil service, 200 psi WP Nitrile

Couplings

Coupled with standard built-in steel nipple/150#RFSSO flanges. Available in other bolt hole patterns, materials and floating flanges on request. Swage nipples are offered up to 10". Hose assembly is electrically continuous unless otherwise specified by customer.

Non-Stock/Sizes

Custom lengths available, contact Customer Service.

Order Codes

- 541-004 (Nitrile Tube)
- 541-586 (Flosyn® Tube)

Smooth Bore Dock 200

SAP #	ID	Nom. OD		Max. WP		Bend Radius		Vacuum HG		Weight			
		Nitrile Tube	Flosyn Tube	in.	mm	psi	MPa	in.	mm	in.	mm	lb./ft.	kg/m
20014752	20248891	4	101.6	5.29	134.4	200	1.38	24	610	29	737	6.15	9.15
20014760	20170662	6	152.4	7.45	189.2	200	1.38	36	914	29	737	11.27	16.77
20014771	20015908	8	203.2	9.62	244.4	200	1.38	48	1219	29	737	16.44	24.46
20452847	20015912	10	254.0	11.62	295.2	200	1.38	60	1524	29	737	21.21	31.56
20014790		12	304.8	13.94	354.1	200	1.38	72	1829	29	737	30.63	45.58

Note: Factory coupled hose manufactured according to the code of Federal Regulations Standard 33 CFR 154.500 and 33 CFR 156.170.

Smooth Bore Dock 300



Product Specifications

Application

For the transfer of petroleum-based products between docks and ships under all types of service conditions. It is available in a number of tube compounds to tailor the fluid handling capabilities to a wide variety of petroleum and chemical compositions.

Construction Tube

Nitrile synthetic rubber for up to 50% aromatics. Also available with a Flosyn® tube for up to 100% aromatics.

Cover

Black Wingprene® synthetic rubber

Reinforcement

Spiral wire helix between plies of synthetic fabric

Temperature Range

-25°F to 200°F (-32°C to 93°C)

Packaging

Chloroplast heavy-duty packaging

Branding (Spiral)

Example: Continental ContiTech SB Dock oil service, 300 psi WP Nitrile

Couplings

Coupled with standard built-in steel nipple/150#RFSSO flanges. Available in other bolt hole patterns, materials and floating flanges on request. Swage nipples are offered up to 10". Hose assembly is electrically continuous unless otherwise specified by customer.

Non-Stock/Sizes

Custom lengths available, contact Customer Service.

Order Codes

541-580 (Nitrile Tube)
541-584 (Flosyn® Tube)

Smooth Bore Dock 300

SAP #		ID		Nom. OD		Max. WP		Bend Radius		Vacuum HG		Weight	
Nitrile Tube	Flosyn Tube	in.	mm	in.	mm	psi	MPa	in.	mm	in.	mm	lb./ft.	kg/m
20274024	20170523	4	101.6	5.29	134.4	300	2.07	27	686	29	737	6.15	9.15
20266243	20015899	8	203.2	9.78	248.4	300	2.07	51	1295	29	737	17.93	26.68
20406529		10	254.0	11.77	299.0	300	2.07	63	1600	29	737	22.99	34.21
20704654		12	304.8	14.15	359.4	300	2.07	75	1905	29	737	33.29	49.54

Note: Factory coupled hose manufactured according to the code of Federal Regulations Standard 33 CFR 154.500 and 33 CFR 156.170.

Air & Multipurpose
General Purpose
Heavy Duty
Push-on

Chemical Transfer

Cleaning Equipment

Food
Transfer
Washdown

Marine

Material Handling
Abrasives
Bulk Transfer
Cement & Concrete

Mining

Petroleum
Aircraft Fueling
Dispensing
Dock
Transfer

Spray

Steam

Vacuum

LPG Delivery

Water
Discharge
Suction & Discharge
Washdown

Welding

Coupling Systems

Equipment

Appendix

Tanker Barge Discharge



Air & Multipurpose

- General Purpose
- Heavy Duty
- Push-on

Chemical Transfer

Cleaning Equipment

- Food**
- Transfer
- Washdown

Marine

- Material Handling**
- Abrasives
- Bulk Transfer
- Cement & Concrete

Mining

- Petroleum**
- Aircraft Fueling
- Dispensing
- Dock
- Transfer

Spray

Steam

Vacuum

LPG Delivery

- Water**
- Discharge
- Suction & Discharge
- Washdown

Welding

Coupling Systems

Equipment

Appendix

Product Specifications

Application

For discharge applications such as the transfer of petroleum-based products between docks and barges.

Construction Tube

Nitrile synthetic rubber for up to 50% aromatics

Cover

Black Wingprene® synthetic rubber

Reinforcement

Spiral-plied synthetic fabric with grounding wires

Temperature Range

-25°F to 220°F (-32°C to 104°C)

Packaging

Chloroplast heavy-duty packaging

Branding (Spiral)

Example: Continental ContiTech Tanker Barge Discharge, 200 psi WP Nitrile

Couplings

Coupled with standard built-in steel nipple/150#RFSSO flanges. Available in other bolt hole patterns, materials and floating flanges on request. Swage nipples are offered up to 10". Hose assembly is electrically continuous unless otherwise specified by customer.

Non-Stock/Sizes

Custom lengths available, contact Customer Service.

Order Codes

541-426 (Nitrile tube)

Tanker Barge Discharge

SAP #	ID	Nom. OD		Max. WP		Weight		
		in.	mm	psi	MPa	lb./ft.	kg/m	
20045864	4	101.6	5.09	129.3	200	1.38	4.30	6.40
20104917	6	152.4	7.08	179.8	200	1.38	6.18	9.20
20136624	8	203.2	9.08	230.6	200	1.38	8.06	11.99
20015537	10	254.0	11.06	280.9	200	1.38	9.93	14.78
20259811	12	304.8	13.28	337.3	200	1.38	13.91	20.70

Note: Factory coupled hose manufactured according to the code of Federal Regulations Standard 33 CFR 154.500 and 33 CFR 156.170.

Vapor Recovery Dock



Product Specifications

Application

For use in the recovery of petroleum vapors during the transfer of petroleum-based products between docks and tankers or barges.

Construction Tube

Nitrile synthetic rubber for up to 50% aromatics. Also available with a Flosyn® tube for up to 100% aromatics.

Cover

Black Chemivic™ synthetic rubber (corrugated)

Reinforcement

Synthetic fabric plies plus two (2) wire helix

Temperature Range

-25°F to 200°F (-32°C to 93°C)

Packaging

Chloroplast heavy-duty packaging

Branding (Spiral)

Example: Continental ContiTech Vapor Recovery 25 psi MWP

Couplings

Built-in nipples (or swaged fittings up to 10" ID) fitted with 150# flange with extra 5/8" diameter hole located midway between flange bolt hole as per Coast Guard requirements.

Non-Stock/Sizes

Custom lengths available, contact Customer Service.

Order Codes

541-090 (Nitrile Tube)

541-643 (Flosyn® Tube)

Vapor Recovery Dock

SAP #	ID		Nom. OD		Max. WP		Bend Radius		Vacuum HG		Weight			
	Nitrile Tube	Flosyn Tube	in.	mm	in.	mm	psi	MPa	in.	mm	in.	mm	lb./ft.	kg/m
		20585185	6	152.4	6.86	174.2	25	0.17	22	559	29	737	5.70	8.48
20157291			8	203.2	8.89	225.8	25	0.17	30	762	29	737	8.26	12.29
20323233			10	254.0	10.97	278.6	25	0.17	40	1016	29	737	12.63	18.80
20014974			12	304.8	13.00	330.2	25	0.17	60	1524	29	737	15.07	22.43

Note: Factory coupled hose manufactured according to the code of Federal Regulations Standard 33 CFR 154.810 and 33 CFR 156.170.

Air & Multipurpose

General Purpose
Heavy Duty
Push-on

Chemical Transfer

Cleaning Equipment

Food

Transfer
Washdown

Marine

Material Handling

Abrasives
Bulk Transfer
Cement & Concrete

Mining

Petroleum

Aircraft Fueling
Dispensing
Dock
Transfer

Spray

Steam

Vacuum

LPG Delivery

Water

Discharge
Suction & Discharge
Washdown

Welding

Coupling Systems

Equipment

Appendix

Plicord® HW Dry Cement/Barytes



Air & Multipurpose

- General Purpose
- Heavy Duty
- Push-on

Chemical Transfer

Cleaning Equipment

- Food**
- Transfer
- Washdown

Marine

Material Handling

- Abrasives
- Bulk Transfer
- Cement & Concrete

Mining

Petroleum

- Aircraft Fueling
- Dispensing
- Dock Transfer

Spray

Steam

Vacuum

LPG Delivery

Water

- Discharge
- Suction & Discharge
- Washdown

Welding

Coupling Systems

Equipment

Appendix

Product Specifications

Application

Heavy duty high performance suction and discharge hose for the bulk transfer of dry cement and barytes from supply vessels to off-shore platform and drilling rigs.

Construction Tube

Black, ChemiTuf® static conducting synthetic rubber

Cover

Black, SBR synthetic rubber with Yellow spiral stripe (Cement) and Orange stripe (Batytes) wrapped finish.

Reinforcement

Spiral-plied (4) synthetic fabric plus helix wire

Temperature Range

-32°F to 82°F (-25°C to 180°C)

Packaging

30.5m coils (available in other lengths up to 122m)

Branding (Spiral)

Example: Continental ContiTech Dry Cement Hardwall
Continental ContiTech Barytes Hardwall

Order Codes

- 549-275 (Cement)
- 549-070 (Barytes)

Plicord® HW Dry Cement/Barytes

ID		Nom. OD		Max. WP		Bend Radius	Weight	
in.	mm	in.	mm	psi	bar	mm	lb./ft.	kg/m
4	102.3	4.84	121.0	150	10	1015	3.16	4.70
5	127.4	5.86	151.0	150	10	1270	5.41	8.04
6	152.6	6.85	176.4	150	10	1525	6.57	9.77

Hose safety factor (burst pressure) 4:1.

Plicord® SW Dry Cement/Barytes



Product Specifications

Application

Heavy duty high performance discharge hose for the bulk transfer of dry cement and barites from supply vessels to off-shore platforms and drilling rigs.

Construction Tube

Black ChemiTuf static dissipation

Cover

Black SBR

Reinforcement

4 plies with static wire

Temperature Range

-32°F to 82°F (-25°C to 180°C)

Packaging

30.5m coils (available in other lengths up to max 122m)

Branding (Spiral)

Dry Cement Softwall by Continental ContiTech
Barytes Softwall by Continental ContiTech

Order Codes

549-274 (Cement)

549-278 (Barytes)

Plicord® SW Dry Cement/Barytes

ID		Nom. OD		Max. WP	Weight
in.	mm	in.	mm	psi	lb./ft.
3	76.0	3.83	97.4	150	2.44
4	101.6	4.85	123.2	150	3.22
5	127.0	5.88	149.4	150	4.13
6	152.4	6.93	176.0	150	5.24

Hose safety factor (burst pressure) 4:1.

Air & Multipurpose

General Purpose
Heavy Duty
Push-on

Chemical Transfer

Cleaning Equipment

Food

Transfer
Washdown

Marine

Material Handling

Abrasives
Bulk Transfer
Cement & Concrete

Mining

Petroleum

Aircraft Fueling
Dispensing
Dock
Transfer

Spray

Steam

Vacuum

LPG Delivery

Water

Discharge
Suction & Discharge
Washdown

Welding

Coupling Systems

Equipment

Appendix

Plicord® Dock Hose



Air & Multipurpose

- General Purpose
- Heavy Duty
- Push-on

Chemical Transfer

Cleaning Equipment

- Food**
- Transfer
- Washdown

Marine

Material Handling

- Abrasives
- Bulk Transfer
- Cement & Concrete

Mining

Petroleum

- Aircraft Fueling
- Dispensing
- Dock
- Transfer

Spray

Steam

Vacuum

LPG Delivery

Water

- Discharge
- Suction & Discharge
- Washdown

Welding

Coupling Systems

Equipment

Appendix

Product Specifications

Application

For the transfer of petroleum products between docks and tankers and is rated for 250 working psi. Not intended for offshore or submarine applications.

Construction Tube

Nitrile synthetic rubber

Cover

1/4" Black SBR synthetic rubber

Reinforcement

Spiral wire helix between plies of synthetic fabric

Temperature Range

-25°F to 180°F (-32°C to 82°C)

Packaging

Heavy-duty plastic packaging

Branding (Impression)

Example: Continental ContiTech SB Submarine oil service, Nitrile 225 psi WP

Couplings

Coupled with galvanized built-in steel nipple/150#RFSO flanges. Available in other bolt hole patterns, materials and floating flanges on request. Hose assembly is electrically continuous unless otherwise specified by customer.

Non-Stock/Sizes

Custom lengths available, contact Customer Service.

Order Codes

541-577

Plicord® Dock Hose

SAP #	ID	Nom. OD		Max. WP		Bend Radius		Weight		
		in.	mm	psi	MPa	in.	mm	lb./ft.	kg/m	
20015841	6	152.4	7.81	198.4	250	1.72	36	914	14.30	21.28
20108741	8	203.2	9.89	251.2	250	1.72	48	1219	20.05	29.84
20161600	10	254.0	12.07	306.6	250	1.72	60	1524	27.23	40.52
20264034	12	304.8	14.10	358.1	250	1.72	72	1829	31.93	47.52

Note: Factory coupled hose manufactured according to the code of Federal Regulations Standard 33 CFR 154.500 and 33 CFR 156.170.

Hot Tar & Asphalt



Product Specifications

Application

Designed for petroleum-based products up to 350°F between docks and tankers or barges under heavy-duty conditions.

Construction Tube

Nitrile synthetic rubber, flat steel wire helix supporting the tube

Cover

Wingprene® synthetic rubber

Reinforcement

Spiral-plyed synthetic fabric with wire helix

Temperature Range

-25°F to 350°F (-32°C to 177°C)

Smooth Bore

Order Codes: 541-606

SAP #	ID	Nom. OD		Max. WP		Bend Radius		Vacuum HG		Weight		
		in.	mm	in.	mm	psi	MPa	in.	mm	in.	mm	lb./ft.
20274024	4	101.6	5.28	134.1	225	1.55	36	914	29	737	6.48	9.64
20276576	6	152.4	7.72	196.1	225	1.55	48	1219	29	737	13.83	20.58
20266243	8	203.2	9.80	248.9	225	1.55	60	1524	29	737	19.11	28.44
20473949	10	254.0	11.80	299.7	225	1.55	80	2032	29	737	23.20	34.52

Rough Bore

Order Codes: 541-582

SAP #	ID	Nom. OD		Max. WP		Bend Radius		Vacuum HG		Weight		
		in.	mm	in.	mm	psi	MPa	in.	mm	in.	mm	lb./ft.
20283225	6	152.4	8.19	208.0	225	1.55	36	914	29	737	16.19	24.09
20288374	8	203.2	10.25	260.4	225	1.55	48	1219	29	737	22.39	33.32
20015897	10	254.0	12.31	312.7	225	1.55	60	1524	29	737	29.09	43.29

Packaging

Custom lengths available, contact Customer Service.

Branding

Example: Continental ContiTech RB Dock hot asphalt, 350°F, 225 psi max

Couplings

Coupled with built-in steel nipple/150#RFSO flanges. Available in other bolt hole patterns, materials and floating flanges on request. Smooth bore assembly is electrically continuous unless otherwise specified by customer. Rough bore assembly is offered as electrically continuous only.

Non-Stock/Sizes

Custom lengths available, contact Customer Service.

Air & Multipurpose

General Purpose
Heavy Duty
Push-on

Chemical Transfer

Cleaning Equipment

Food
Transfer
Washdown

Marine

Material Handling

Abrasives
Bulk Transfer
Cement & Concrete

Mining

Petroleum
Aircraft Fueling
Dispensing
Dock
Transfer

Spray

Steam

Vacuum

LPG Delivery

Water

Discharge
Suction & Discharge
Washdown

Welding

Coupling Systems

Equipment

Appendix

Oil Rig Service Hose with Integral Positive Float System



Product Specifications

Application

Hose specifically designed to be used on service vessels to offshore drilling and production platforms for the transfer of a wide range of products from petroleum to drinking water. The unique positive float system allows the hose to maintain flotation with products of various specific gravities.

The system consists of a section of floating hose up to a length of 30.5m which may be attached to various lengths of hose (up to 120m) attached to the supply vessel. In addition the supply hose may incorporate intergrated wear strips on the cover to improve the abrasion resistance of the hose. The system may be stored on platform reeling systems and the hoses may be supplied with a RFID chip for intergrated hose management.

Construction Tube

Various synthetic rubber compounds are offered depending on hose service and product conveyed

Cover

Synthetic rubber with excellent resistance to ozone and weathering. An abrasion strip is available to extend the service life of the outer hose

Reinforcement

Spiral reinforcement plies available with (Hardwall) or without (Softwall) helix wire

Positive float

Well proven closed cell foam floating material used also in OCIMF hoses. Foam thickness design based upon product conveyed as specified by the customer. The foam is covered with an integral orange rubber cover.

Approvals

Currently in use in the North Sea with major oil and drilling companies.

Branding

Standard ContiTech brand

Temperature

-22°F to 180°F (-30°C to 82°C)

Lengths

Custom built, up to 30.5m (100ft) with floatation and 120m (400ft.) without

Colors

Available in orange or black

Couplings

A range of internally and external swaged fittings and "built in" fittings are available for these hoses

Packaging

Bulk and coupled assemblies available

Dimensions

See below. Other diameter/design available upon request.

Air & Multipurpose

- General Purpose
- Heavy Duty
- Push-on

Chemical Transfer

Cleaning Equipment

- Food**
- Transfer
- Washdown

Marine

- Material Handling**
- Abrasives
- Bulk Transfer
- Cement & Concrete

Mining

- Petroleum**
- Aircraft Fueling
- Dispensing
- Dock
- Transfer

Spray

Steam

Vacuum

LPG Delivery

Water

- Discharge
- Suction & Discharge
- Washdown

Welding

Coupling Systems

Equipment

Appendix

3" Positive Float

ID		Max. WP			Max SG*		
in.	mm	mm	psi	bar	mm	kg/m	g/cm ³
2	51	220	290	20	510	8.35	8.00
3	76	240	290	20	760	9.90	4.20
4	102	270	290	20	1020	11.63	3.10

1½" Positive Float

ID		Max. WP			Max SG*		
in.	mm	mm	psi	bar	mm	kg/m	g/cm ³
2	51	140	290	20	510	3.5	3.10
3	76	160	290	20	760	4.39	1.90
4	102	190	290	20	1020	5.37	1.60

Hose safety factor (burst pressure) 3:1. *Floating hose OD's are based on 3" and 1½" floatation material and Rig Supply Softwall Hose

*For vacuum service Rig Supply Hardwall is utilised *Max SG - Maximum Specific Gravity of the product allowed to have a Reserved Buoyancy of Min +25%

Air & Multipurpose

General Purpose
Heavy Duty
Push-on

Chemical Transfer

Cleaning Equipment

Food

Transfer
Washdown

Marine

Material Handling

Abrasives
Bulk Transfer
Cement & Concrete

Mining

Petroleum

Aircraft Fueling
Dispensing
Dock
Transfer

Spray

Steam

Vacuum

LPG Delivery

Water

Discharge
Suction & Discharge
Washdown

Welding

Coupling Systems

Equipment

Appendix

RB Dock Asphalt & Bitumen EN 13482



Air & Multipurpose

- General Purpose
- Heavy Duty
- Push-on

Chemical Transfer

Cleaning Equipment

- Food**
- Transfer
- Washdown

Marine

- Material Handling**
- Abrasives
- Bulk Transfer
- Cement & Concrete

Mining

- Petroleum**
- Aircraft Fueling
- Dispensing
- Dock
- Transfer

Spray

Steam

Vacuum

LPG Delivery

- Water**
- Discharge
- Suction & Discharge
- Washdown

Welding

Coupling Systems

Equipment

Appendix

Product Specifications

Application

Rough Bore (RB) Dock hose, designed for asphalt and bitumen products up to 200°C (392°F) dockside transfer between docks and ships, all sizes rated at full vacuum.

Construction Tube

Black, oil resistant Chemigum® (Nitrile) synthetic rubber, supported by a flat steel helix wire

Cover

Black, ozone, oil, sea water and abrasion resistant Nitrilesynthetic rubber

Reinforcement

Spiral wire helix between plies of synthetic fabric

Temperature Range

-37°F to 200°F (-30°C to 392°C)

Branding (Spiral)

Coast Guard & Stainless steel name plate at both ends:
Example: Continental ContiTech Asphalt and Bitumen EN 13482:2001 Type 2, RB, ID mm, 15 bar, 200°C

Couplings

Built-in couplings with flanges supplies to customer requirements

Standards

ISO 1307
BS EN 13482 Type 2, Class B
Coast Guard Federal Regulations, Title 33, Chapter 1, Subpart C clause 154.500

Product Code

Built to length. Please contact our marketing department for further details.

RB Dock Asphalt & Bitumen EN 13482

ID		Nom OD		Max. WP	Bend Radius	Weight
in.	mm	mm	bar	MPa	mm	g/m
6	152.4	208.0	15	225	1015	19790
8	203.2	253.2	15	225	1270	27680
10	254.0	304.8	15	225	1525	33630

Hose safety factor (burst pressure) 6:1. Vacuum resistance up to -0.9 bar.

SB Dock Asphalt & Bitumen EN 13482



Product Specifications

Application

Rough Bore (RB) Dock hose, designed for asphalt and bitumen products up to 200°C (392°F) dockside transfer between docks and ships, all sizes rated at full vacuum.

Construction Tube

Black, oil resistant Chemigum® (Nitrile) synthetic rubber, supported by a flat steel helix wire

Cover

Black, ozone, oil, sea water and abrasion resistant Nitrilesynthetic rubber

Reinforcement

Spiral wire helix between plies of synthetic fabric

Temperature Range

-37°F to 200°F (-30°C to 392°C)

Branding (Spiral)

Coast Guard & Stainless steel name plate at both ends:
Example: Continental ContiTech Asphalt and Bitumen EN 13482:2001 Type 2, RB, ID mm, 15 bar, 200°C

Couplings

Built-in couplings with flanges supplies to customer requirements

Standards

ISO 1307
BS EN 13482 Type 2, Class B
Coast Guard Federal Regulations, Title 33, Chapter 1, Subpart C clause 154.500

Product Code

Built to length. Please contact our marketing department for further details.

Order Code

541-240

RB Dock Asphalt & Bitumen EN 13482

ID		Nom OD	Max. WP		Bend Radius	Weight
in.	mm	mm	bar	MPa	mm	g/m
4	101.6	134.9	15	225	605	9520
6	152.4	208.0	15	225	825	19790
8	203.2	253.2	15	225	1120	27680
10	254.0	304.8	15	225	1395	33630

Hose safety factor (burst pressure) 6:1. Vacuum resistance up to -0.9 bar.

Air & Multipurpose

General Purpose
Heavy Duty
Push-on

Chemical Transfer

Cleaning Equipment

Food Transfer Washdown

Marine

Material Handling

Abrasives
Bulk Transfer
Cement & Concrete

Mining

Petroleum Aircraft Fueling Dispensing Dock Transfer

Spray

Steam

Vacuum

LPG Delivery

Water Discharge Suction & Discharge Washdown

Welding

Coupling Systems

Equipment

Appendix

Transfer



Air & Multipurpose

- General Purpose
- Heavy Duty
- Push-on

Chemical Transfer

Cleaning Equipment

Food

- Transfer
- Washdown

Marine

Material Handling

- Abrasives
- Bulk Transfer
- Cement & Concrete

Mining

Petroleum

- Aircraft Fueling
- Dispensing
- Dock Transfer

Spray

Steam

Vacuum

LPG Delivery

Water

- Discharge
- Suction & Discharge
- Washdown

Welding

Coupling Systems

Equipment

Appendix

	Page	Temp. Range	Refined Fuels	Corrugated Cover	Lightweight
Arctic ExtremeFlex	196	-65°F to 180°F (-54°C to 82°C)	Yes	Yes	Yes
Blue Low Temp Fuel Oil Delivery	194	-40°F to 140°F (-40°C to 60°C)	Yes		
Flexwing VersaFuel	197	-30°F to 180°F (-35°C to 82°C)	Yes		
Infinity Fuel Drop Hose	198	-40°F to 160°F (-40°C to 71°C)	Yes	Yes	Yes
Infinity HD Fuel Drop Hose	199	-40°F to 160°F (-40°C to 71°C)	Yes	Yes	Yes
LW Arctic Tank Truck	208	-65°F to 180°F (-54°C to 82°C)		Yes	Yes
Paladin	201	-40°F to 160°F (-40°C to 71°C)	Yes	Yes	Yes
Plicord Arctic Flexwing	209	-65°F to 180°F (-54°C to 82°C)	Yes		
Plicord ExtremeFlex	211	-40°F to 200°F (-40°C to 93°C)	Yes	Yes	Yes
Plicord Flexwing Petroleum	200	-35°F to 200°F (-37°C to 93°C)	Yes		
Plicord Fuel Discharge	210	-35°F to 180°F (-37°C to 82°C)	Yes		
Plicord LW Black Flextra II	205	-40°F to 180°F (-40°C to 82°C)	Yes	Yes	Yes
Plicord Oilfield Frac	204	-25°F to 180°F (-32°C to 82°C)			
Plicord Super Black Flexwing	203	-35°F to 200°F (-37°C to 93°C)	Yes		
Prospector Oilfield 150	206	-25°F to 180°F (-32°C to 82°C)			
Prospector Oilfield 300	207	-35°F to 180°F (-37°C to 82°C)			
Pyroflex Hot Tar & Asphalt II	213	-25°F to 350°F (-32°C to 177°C)			
Pyroflex Hot Tar Wand	214	-25°F to 350°F (-32°C to 177°C)			
Redwing Fuel Oil	195	-40°F to 140°F (-40°C to 60°C)	Yes		
Red Flextra 100 & 150	202	-30°F to 180°F (-34°C to 82°C)			
Spiraflex Polyurethane Vapor Recovery	212	-30°F to 150°F (-35°C to 66°C)		Yes	Yes

Blue Low Temp Fuel Oil Delivery



Product Specifications

Application

The new and improved Low Temperature Fuel Oil Delivery Hose is for transfer and delivery of fuel oil and petroleum products for home delivery, commercial, and industrial service designed to remain flexible in cold temperatures and provide superior oil resistance. The braided construction reduces kinking and twisting when reeling. The smooth cover has low drag resistance.

Construction Tube

Nitrile (ORS)

Cover

Blue Chemivic™ Synthetic Rubber (ORS) (Smooth Finish)

Reinforcement

Two Braid Textile with Static Wire

Temperature Range

-40°F to 140°F (-40°C to 60°C)

Packaging

Cut Lengths

Branding (Spiral)

Example: 1¼" (31.75) Continental ContiTech Low Temp Fuel Oil A/S. Made in U.S.A.

Order Codes

532-021

Blue Low Temp Fuel Oil Delivery

SAP #	Color	ID/in.	ID/mm	Length	Stocked	psi	Weight	Product Code
20054898	Blue	1¼	31.75	100'	YES	250	.65 / FT	53202104010000
20031895	Blue	1¼	31.75	125'	YES	250	.65 / FT	53202104012500
20031896	Blue	1¼	31.75	150'	YES	250	.65 / FT	53202104015000
20054428	Blue	1¼	31.75	175'	N/S	250	.65 / FT	53202104017500
20031897	Blue	1⅜	34.92	125'	YES	250	.70 / FT	53202104412500
20031898	Blue	1⅜	34.92	150'	YES	250	.70 / FT	53202104415000
20145510	Blue	1⅜	34.92	175'	N/S	250	.70 / FT	53202104417500
20750636	Blue	1½	38.10	100'	2500'	250	.92 / FT	53202104810000
20046244	Blue	1½	38.10	125'	2500'	250	.92 / FT	53202104812500
20031899	Blue	1½	38.10	150'	2500'	250	.92 / FT	53202104815000
20750635	Blue	1½	38.10	175'	2500'	250	.92 / FT	53202104817500

Air & Multipurpose

General Purpose
Heavy Duty
Push-on

Chemical Transfer

Cleaning Equipment

Food
Transfer
Washdown

Marine

Material Handling
Abrasives
Bulk Transfer
Cement & Concrete

Mining

Petroleum
Aircraft Fueling
Dispensing
Dock
Transfer

Spray

Steam

Vacuum

LPG Delivery

Water
Discharge
Suction & Discharge
Washdown

Welding

Coupling Systems

Equipment

Appendix

Redwing® Fuel Oil



Air & Multipurpose
 General Purpose
 Heavy Duty
 Push-on

Chemical Transfer

Cleaning Equipment

Food
 Transfer
 Washdown

Marine

Material Handling
 Abrasives
 Bulk Transfer
 Cement & Concrete

Mining

Petroleum
 Aircraft Fueling
 Dispensing
 Dock
 Transfer

Spray

Steam

Vacuum

LPG Delivery

Water
 Discharge
 Suction & Discharge
 Washdown

Welding

Coupling Systems

Equipment

Appendix

Product Specifications

Application

Redwing® Fuel Oil is for transfer and delivery of fuel oil and petroleum products for home delivery, commercial and industrial service. Redwing Fuel Oil has two textile braids. The braided construction reduces kinking and twisting when reeling. The smooth cover has low drag resistance.

Construction Tube

Nitrile synthetic rubber (ORS)

Cover

Red Chemivic™ synthetic rubber (smooth finish) (ORS)

Reinforcement

Braided (2) synthetic yarn

Temperature Range

-40°F to 140°F (-40°C to 60°C)

Packaging

Reels, cut lengths, and coupled lengths

Branding

Example: 1" (25.4mm) 2 BD Redwing® Fuel Oil Continental ContiTech Made in U.S.A.

Couplings

Contact fitting manufacturer for proper fitting recommendation and coupling procedure.

Order Codes

532-016

Redwing® Fuel Oil

SAP #	ID		Nom. OD		Max. WP		Weight	
	in.	mm	in.	mm	psi	MPa	lb./ft.	kg/m
20021667	1	25.4	1.50	38.1	250	1.72	0.57	0.85
20021681	1¼	31.8	1.80	45.7	250	1.72	0.65	0.97
20021708	1⅜	34.9	1.88	47.8	250	1.72	0.70	1.04
20021735	1½	38.1	2.10	53.3	150	1.03	0.92	1.37

Arctic ExtremeFlex™

A New Degree of Flexibility



Product Specifications

Application

An extremely flexible and lightweight drop hose for transfer of petroleum-based products under suction, low-pressure discharge or gravity flow. Flexibility maintained down to -65°F (-54°C).

Construction Tube

Black Nitrile, RMA Class A (High Oil Resistance)

Cover

Corrugated Black Wingprene® synthetic rubber (wrapped impression), blue spiral stripe
Corrugated Blue Wingprene® synthetic rubber (wrapped impression), red spiral stripe

Reinforcement

Spiral-plied synthetic fabric with double wire helix

Temperature Range

-65°F to 180°F (-54°C to 82°C)

Packaging

Coiled and polywrapped

Branding (Spiral)

Example: Continental ContiTech Plicord® Arctic ExtremeFlex™ Petroleum Transfer 150 psi WP

Couplings

Use Continental ContiTech Insta-Lock™ Cam & Groove Fittings

Non-Stock/Sizes

400' minimum order

Non-Stock/Sizes

543-807 (black)
543-451 (blue)

Arctic ExtremeFlex™

SAP #		ID		Nom. OD		Max. WP		Bend Radius		Vacuum HG		Weight	
Black	Blue	in.	mm	in.	mm	psi	MPa	in.	mm	in.	mm	lb./ft.	kg/m
20476228	20484433	2	51	2.5	63.5	150	1.03	2	51	29	737	1.08	1.61
20476229	20484435	3	76	3.48	88.5	150	1.03	3	76	29	737	1.62	2.41
20476250	20484436	4	102	4.55	115.7	150	1.03	4	102	29	737	2.35	3.50



Air & Multipurpose
General Purpose
Heavy Duty
Push-on

Chemical Transfer

Cleaning Equipment

Food
Transfer
Washdown

Marine

Material Handling
Abrasives
Bulk Transfer
Cement & Concrete

Mining

Petroleum
Aircraft Fueling
Dispensing
Dock
Transfer

Spray

Steam

Vacuum

LPG Delivery

Water
Discharge
Suction & Discharge
Washdown

Welding

Coupling Systems

Equipment

Appendix

Flexwing VersaFuel™



Product Specifications

Air & Multipurpose

- General Purpose
- Heavy Duty
- Push-on

Chemical Transfer

Cleaning Equipment

- Food**
- Transfer
- Washdown

Marine

Material Handling

- Abrasives
- Bulk Transfer
- Cement & Concrete

Mining

Petroleum

- Aircraft Fueling
- Dispensing
- Dock
- Transfer

Spray

Steam

Vacuum

LPG Delivery

Water

- Discharge
- Suction & Discharge
- Washdown

Welding

Coupling Systems

Equipment

Appendix

Application

For use in tank truck and in-plant operation to transfer diesel, biodiesel blends, B-100, ethanol blends, gasoline, oil and petroleum base products up to 60% aromatic content.

Construction Tube

Synthetic rubber (static dissipating)

Cover

Black synthetic rubber with excellent resistance to biodiesel, ethanol, oil/petroleum products and abrasion.

Reinforcement

Spiral-plied synthetic fabric with helix wire

Temperature Range

-30°F to 180°F (-34°C to 82°C)

Packaging

100' lengths, coiled and polywrapped.

Branding (Spiral)

Example: Continental ContiTech Flexwing VersaFuel™ 150 psi WP

Couplings

Use Continental ContiTech Insta-Lock™ Cam and Groove fittings with this product.

Non-Stock/Sizes

400' minimum order

Order Codes

543-422

Flexwing VersaFuel™

SAP #	ID	Nom. OD		Max. WP		Bend Radius		Vacuum HG		Weight		
		in.	mm	in.	mm	in.	mm	in.	mm	lb./ft.	kg/m	
20339606	1	25.4	1.50	38.1	150	1.03	2	50	29	737	0.59	0.88
20339625	1¼	32.0	1.77	44.8	150	1.03	3	75	29	737	0.74	1.10
20339626	1½	38.0	2.03	51.7	150	1.03	4	100	29	737	0.92	1.37
20339628	2	51.2	2.55	64.9	150	1.03	5	125	29	737	1.21	1.80
20339627	2½	63.7	3.07	77.9	150	1.03	6	150	29	737	1.56	2.32
20339629	3	76.1	3.58	91.0	150	1.03	7	175	29	737	1.94	2.89
20339650	4	102.1	4.60	117.0	150	1.03	10	200	29	737	2.53	3.77

Infinity™ Fuel Drop Hose



Product Specifications

Application

Constructed with the exclusive PVC double helix for superior flexibility, abrasion resistance and low coefficient of friction for ease of maneuverability. Lightweight in construction, it is designed to transfer biodiesel and ethanol blends, gasoline and other petroleum products under pressure, gravity flow or medium suction (up to 23" Hg) at ambient temperature and with an aromatic content of 60% or less.

Construction Tube

Black Nitrile synthetic rubber (static dissipating)

Cover

Black Chemivic™ synthetic rubber with orange & green Pliovic® outer helix

Reinforcement

Synthetic fabric plies with static wire

Temperature Range

-40°F to 160°F (-40°C to 71°C)

Packaging

Coiled and polywrapped. For cut length, check with your Continental ContiTech distributors.

Branding

Example: Infinity™ Drop Hose Continental ContiTech

Couplings

Use Continental ContiTech Insta-Lock™ Cam & Groove Fittings with this product.

Order Codes

543-773

Infinity™

SAP #	ID	Nom. OD		Max. WP		Bend Radius		Vacuum HG		Weight		
		in.	mm	in.	mm	in.	mm	in.	mm	lb./ft.	kg/m	
20414700	2	51.0	2.80	70.50	150	1.03	1.5	1.02	23	584	1.02	1.52
20414701	3	76.0	3.80	95.48	100	0.69	2.0	1.46	23	584	1.46	2.18
20414702	4	102.0	4.80	121.47	75	0.52	2.5	1.73	23	584	1.73	2.57

Air & Multipurpose

General Purpose
Heavy Duty
Push-on

Chemical Transfer

Cleaning Equipment

Food
Transfer
Washdown

Marine

Material Handling
Abrasives
Bulk Transfer
Cement & Concrete

Mining

Petroleum
Aircraft Fueling
Dispensing
Dock
Transfer

Spray

Steam

Vacuum

LPG Delivery

Water
Discharge
Suction & Discharge
Washdown

Welding

Coupling Systems

Equipment

Appendix

Infinity™ HD Fuel Drop Hose



Product Specifications

Air & Multipurpose

- General Purpose
- Heavy Duty
- Push-on

Chemical Transfer

Cleaning Equipment

- Food Transfer
- Washdown

Marine

- Material Handling
- Abrasives
- Bulk Transfer
- Cement & Concrete

Mining

- Petroleum
- Aircraft Fueling
- Dispensing
- Dock Transfer

Spray

Steam

Vacuum

LPG Delivery

- Water Discharge
- Suction & Discharge
- Washdown

Welding

Coupling Systems

Equipment

Appendix

Application

Constructed with the exclusive PVC double helix for superior flexibility, abrasion resistance and low coefficient of friction for ease of maneuverability. Lightweight in construction, Infinity™ HD (Heavy Duty) is designed for higher working pressure applications (150 psi). It is suitable in gravity flow or medium suction at ambient temperature. Designed to transfer biodiesel and ethanol blends, gasoline and other petroleum products with an aromatic content of 60% or less.

Construction Tube

Black Nitrile synthetic rubber (static dissipating)

Cover

Synthetic fabric plies

Reinforcement

Black Chemivic™ synthetic rubber with double Orange Pliovic® outer helix

Temperature Range

-40°F to 160°F (-40°C to 71°C)

Packaging

Coiled and polywrapped. For cut length, check with your Continental ContiTech Authorized Distributor.

Branding

Infinity™ HD Drop Hose 150psi Continental ContiTech

Couplings

Use Continental ContiTech Insta-Lock™ Cam & Groove Fittings with this product. See the Coupling Systems information pages at the back of the catalog.

Order Codes

543-138

Infinity™ HD Fuel Drop Hose

SAP #	ID	Nom. OD		Max. WP		Bend Radius		Vacuum HG		Weight		
		in.	mm	in.	mm	psi	MPa	in.	mm	in.	mm	lb./ft.
20439969	2	51.0	2.80	70.50	150	1.03	1.5	38.1	23	584	1.01	1.51
20439980	3	76.0	3.80	95.90	150	1.03	2.0	50.8	23	584	1.48	2.21
20439981	4	102.0	4.80	122.50	150	1.03	3.0	76.2	23	584	2.01	2.99

Plicord® Flexwing® Petroleum



Product Specifications

Application

For use in tank truck and in-plant operations to transfer gasoline, oil, ethanol blends and other petroleum base products up to 50% aromatic content. It is designed for pressure, gravity flow, or full-suction service.

Construction Tube

Nitrile synthetic rubber RMA Class A (High Oil Resistance)

Cover

Black (red spiral stripe) or Red Chemivic™ (white spiral stripe) synthetic rubber (oil resistant); smooth cover; wrapped finish

Reinforcement

Spiral-plied synthetic fabric with wire helix

Temperature Range

-35°F to 200°F (-37°C to 93°C)

Packaging

100' lengths, coiled and polywrapped

Branding (Spiral)

Example: Continental ContiTech Flexwing® Petroleum 150 psi WP

Couplings

Use Continental ContiTech Insta-Lock™ Cam & Groove Fittings with this product. See the Coupling Systems information pages at the back of the catalog.

Order Codes

543-109 (black)
543-110 (red)
541-109 (black 8-inch size)

Plicord® Flexwing® Petroleum

SAP #	ID		Nom. OD		Max. WP		Bend Radius		Vacuum HG		Weight			
	Black	Red	in.	mm	in.	mm	psi	MPa	in.	mm	in.	mm	lb./ft.	kg/m
20050548			3/4	19.1	1.22	31.0	150	1.03	2	51	29	737	0.47	0.70
20017481	20392618		1	25.4	1.50	38.1	150	1.03	2	51	29	737	0.63	0.94
20017482	20017530		1¼	31.8	1.76	44.7	150	1.03	3	76	29	737	0.79	1.18
20017488	20017532		1½	38.1	2.03	51.6	150	1.03	4	102	29	737	0.99	1.47
20050549			1¾	44.5	2.28	57.9	150	1.03	4	102	29	737	1.07	1.59
20017496	20017537		2	50.8	2.55	64.8	150	1.03	5	114	29	737	1.30	1.93
20017502	20017541		2½	63.5	3.07	78.0	150	1.03	6	146	29	737	1.66	2.47
20017508	20017543		3	76.2	3.57	90.7	150	1.03	7	178	29	737	2.03	3.02
20017513			3½	88.9	4.13	104.9	150	1.03	8	203	29	737	2.39	3.56
20017516	20017546		4	101.6	4.60	116.8	150	1.03	10	254	29	737	2.68	3.99
20017526			6	152.7	6.78	171.9	150	1.03	30	762	29	737	5.61	8.36

Air & Multipurpose

General Purpose
Heavy Duty
Push-on

Chemical Transfer

Cleaning Equipment

Food Transfer Washdown

Marine

Material Handling Abrasives Bulk Transfer Cement & Concrete

Mining

Petroleum Aircraft Fueling Dispensing Dock Transfer

Spray

Steam

Vacuum

LPG Delivery

Water Discharge Suction & Discharge Washdown

Welding

Coupling Systems

Equipment

Appendix

Paladin®

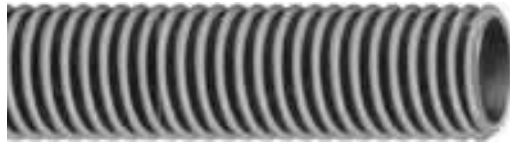

Product Specifications

Air & Multipurpose

- General Purpose
- Heavy Duty
- Push-on

Chemical Transfer

Cleaning Equipment

- Food**
- Transfer
- Washdown

Marine

Material Handling

- Abrasives
- Bulk Transfer
- Cement & Concrete

Mining

Petroleum

- Aircraft Fueling
- Dispensing
- Dock
- Transfer

Spray

Steam

Vacuum

LPG Delivery

Water

- Discharge
- Suction & Discharge
- Washdown

Welding

Coupling Systems

Equipment

Appendix

Application

Designed as a lightweight and flexible hose to transfer biodiesel and ethanol blends, gasoline and other petroleum products under pressure, gravity flow or medium suction (up to 23" Hg) at ambient temperature. Maximum aromatic content 60%. Outer PVC helix provides abrasion resistance and low coefficient of friction. With Antistatic wire (low resistance).

Construction Tube

Black Nitrile synthetic rubber (static dissipating)

Cover

Black Chemivic™ synthetic rubber with double Orange Pliovic® outer helix

Reinforcement

Synthetic fabric plies

Temperature Range

-40°F to 160°F (-40°C to 71°C)

Packaging

100' lengths, coiled and bagel pack

Branding

Example: Continental ContiTech Paladin® Drop Hose (Date Code). Made in Canada

Couplings

Use Continental ContiTech Insta-Lock™ Cam & Groove Fittings with this product. See the Coupling Systems information pages at the back of the catalog.

Order Codes

543-227

Paladin®

SAP #	ID	Nom. OD		Max. WP		Bend Radius		Vacuum HG		Weight		
		in.	mm	in.	mm	in.	mm	in.	mm	lb./ft.	kg/m	
20130856	2	50.8	2.87	72.9	150	1.03	2	51	23	584	1.04	1.55
20130857	3	76.2	3.92	99.6	150	1.03	3	76	23	584	1.58	2.35
20131000	4	101.6	4.85	123.2	75	0.52	5	127	23	584	1.94	2.89

Red Flextra®



Product Specifications

Application

For the transfer of ethanol blends, gasoline and other petroleum-based products under pressure, gravity flow or full-suction where maximum flexibility is needed.

Construction Tube

Nitrile synthetic rubber RMA Class A (High Oil Resistance)

Cover

Red Wingprene®, corrugated synthetic rubber RMA Class C (Oil Resistance)

Reinforcement

Spiral-plied synthetic fabric with double wire helix

Temperature Range

-30°F to 180°F (-34°C to 82°C)

Red Flextra® 100

Order Codes: 543-123

SAP #	ID	Nom. OD		Max. WP		Bend Radius		Vacuum HG		Weight		
		in.	mm	in.	mm	in.	mm	in.	mm	lb./ft.	kg/m	
20017589	2	50.8	2.38	60.3	100	0.69	4	102	29	737	0.83	1.09
20017593	2½	63.5	2.88	73.2	100	0.69	5	127	29	737	1.09	1.62
20017598	3	76.2	3.41	86.6	100	0.69	6	152	29	737	1.41	2.10
20017600	4	101.6	4.53	115.1	100	0.69	9	229	29	737	2.23	3.32

Red Flextra® 150

Order Codes: 543-120

SAP #	ID	Nom. OD		Max. WP		Bend Radius		Vacuum HG		Weight		
		in.	mm	in.	mm	psi	MPa	in.	mm	in.	mm	lb./ft.
20017582	2	50.8	2.52	64.0	150	1.03	4	102	29	737	1.18	1.76
20017583	3	76.2	3.59	91.2	150	1.03	6	152	29	737	1.99	2.96
20017584	4	101.6	4.61	117.1	150	1.03	9	229	29	737	2.66	3.96

Air & Multipurpose
General Purpose
Heavy Duty
Push-on

Chemical Transfer

Cleaning Equipment

Food
Transfer
Washdown

Marine

Material Handling
Abrasives
Bulk Transfer
Cement & Concrete

Mining

Petroleum
Aircraft Fueling
Dispensing
Dock
Transfer

Spray

Steam

Vacuum

LPG Delivery

Water
Discharge
Suction & Discharge
Washdown

Welding

Coupling Systems

Equipment

Appendix

Plicord® Super Black Flexwing®



Product Specifications

Air & Multipurpose

- General Purpose
- Heavy Duty
- Push-on

Chemical Transfer

Cleaning Equipment

- Food Transfer
- Washdown

Marine

Material Handling

- Abrasives
- Bulk Transfer
- Cement & Concrete

Mining

Petroleum

- Aircraft Fueling
- Dispensing
- Dock Transfer

Spray

Steam

Vacuum

LPG Delivery

- Water Discharge
- Suction & Discharge
- Washdown

Welding

Coupling Systems

Equipment

Appendix

Application

A premium high-pressure petroleum transfer hose for handling ethanol blends, gasoline, oils and other petroleum products at higher working pressures.

Construction Tube

Special fuel-resistant Black nitrile synthetic rubber RMA Class A (High Oil Resistance)

Cover

Black Chemivic™ smooth cover with wrapped finish. Also available with ARC treatment for improved abrasion resistance. Both hoses standard with built in blue wear ply to illustrate wear condition and potential trigger point for product replacement.

Reinforcement

Spiral-plyed synthetic fabric with wire helix

Temperature Range

-35°F to 200°F (-37°C to 93°C)

Packaging

100' lengths, coiled and polywrapped

Branding

Example: Continental ContiTech Flexwing® Petroleum Hose

Couplings

Use Continental ContiTech Insta-Lock™ Cam & Groove Fittings with this product. See the Coupling Systems information pages at the back of the catalog.

Order Codes

- 543-117
- 541-117 (6" diameter, 100' length)

Plicord Super Black Flexwing®

SAP #	ID	Nom. OD		Max. WP		Bend Radius		Vacuum HG		Weight		
		in.	mm	in.	mm	in.	mm	in.	mm	lb./ft.	kg/m	
20155914	1¼	31.8	1.87	47.1	300	2.07	4	100	29	737	.99	1.48
20017550	1½	38.1	2.08	52.8	300	2.07	4	100	29	737	1.15	1.71
20017552	2	50.8	2.59	65.8	300	2.07	5	125	29	737	1.44	2.14
20017558	2½	63.5	3.11	79.0	300	2.07	6	150	29	737	1.84	2.74
20017560	3	76.2	3.65	92.7	300	2.07	7	175	29	737	2.39	3.56
20017564	4	101.6	4.83	122.7	300	2.07	10	254	29	737	3.76	5.60
20017568	5	127.0	5.87	149.0	300	2.07	20	500	29	737	5.10	7.60
20338990	6	152.4	7.21	183.3	300	2.07	24	600	29	737	8.46	12.60

Plicord® Oilfield Frac



Product Specifications

Application

A rugged and flexible hose designed to convey crude oil and oil slurry mixtures for Frac tank connections.

Construction Tube

Black Nitrile

Cover

Black Chemivic™, smooth cover with wrapped finish. Also available with ARC treatment for improved abrasion resistance.

Reinforcement

Multiple plies of synthetic fabric

Temperature Range

-25°F to 180°F (-32°C to 82°C)

Packaging

100' length, coiled and polywrapped

Branding (Spiral)

Continental ContiTech Oilfield Fracturing Hose

Couplings

Contact fitting supplier

Order Codes

543-827
543-710 (ARC Treatment)
541-710

Plicord® Oilfield Frac

SAP #	ID		Nom. OD		Max. WP		Weight	
	in.	mm	in.	mm	psi	MPa	lb./ft.	kg/m
20118130	3	76.2	3.87	98.30	400	2.76	2.52	3.74
20018362	4	101.6	4.76	120.85	400	2.76	2.85	4.21

Air & Multipurpose

General Purpose
Heavy Duty
Push-on

Chemical Transfer

Cleaning Equipment

Food Transfer Washdown

Marine

Material Handling

Abrasives
Bulk Transfer
Cement & Concrete

Mining

Petroleum

Aircraft Fueling
Dispensing
Dock
Transfer

Spray

Steam

Vacuum

LPG Delivery

Water

Discharge
Suction & Discharge
Washdown

Welding

Coupling Systems

Equipment

Appendix

Plicord® LW Black Flextra II™



Product Specifications

Air & Multipurpose

- General Purpose
- Heavy Duty
- Push-on

Chemical Transfer

Cleaning Equipment

- Food**
- Transfer
- Washdown

Marine

Material Handling

- Abrasives
- Bulk Transfer
- Cement & Concrete

Mining

Petroleum

- Aircraft Fueling
- Dispensing
- Dock
- Transfer

Spray

Steam

Vacuum

LPG Delivery

Water

- Discharge
- Suction & Discharge
- Washdown

Welding

Coupling Systems

Equipment

Appendix

Application

Used by tank trucks, bulk petroleum stations, and others to transfer ethanol blends and petroleum products under pressure, suction and/or gravity flow. Extremely flexible and lightweight to provide excellent service. Not recommended where aromatic content exceeds 50%.

Construction Tube

Black Nitrile RMA Class A (High Oil Resistance)

Cover

Black Chemivic™ (corrugated)

Reinforcement

Spiral-plied synthetic fabric with double wire helix

Temperature Range

-40°F to 180°F (-40°C to 82°C)

Packaging

100' lengths, coiled and polywrapped

Branding (Spiral)

Example: Continental ContiTech LW Black Flextra II™ 75 psi Max WP

Couplings

Contact fitting manufacturer for proper fitting recommendation and coupling procedure.

Order Codes

543-562

Plicord® LW Black Flextra II™

SAP #	ID		Nom. OD		Max. WP		Bend Radius		Vacuum HG		Weight	
	in.	mm	in.	mm	psi	MPa	in.	mm	in.	mm	lb./ft.	kg/m
20017959	2	50.8	2.42	61.5	75	0.52	3	76	29	737	0.94	1.40
20017961	2½	63.5	2.92	74.2	75	0.52	4	102	29	737	1.22	1.82
20017962	3	76.2	3.40	86.4	75	0.52	4	102	29	737	1.39	2.07
20017965	4	101.6	4.53	115.1	75	0.52	7	178	29	737	2.37	3.53

Prospector™ Oilfield 150



Product Specifications

Application

For use in transfer hose service, cleaning sediment from oil storage tanks and other general service applications. The tube is an oil-resistant synthetic rubber. Do not use with gasoline and other refined products when aromatic content exceeds 35%.

Construction Tube

Synthetic rubber

Cover

Black SBR synthetic rubber (smooth cover)

Reinforcement

Spiral-plied synthetic fabric with wire helix

Temperature Range

-25°F to 180°F (-32°C to 82°C)

Packaging

100' lengths, coiled and polywrapped

Branding (Spiral)

Example: Continental ContiTech Prospector™ Oilfield 150

Couplings

Use Continental ContiTech Insta-Lock Cam & Groove Fittings with this product. See the Coupling Systems information pages at the back of the catalog.

Order Codes

543-456 (1")

543-655 (1 1/4" - 6")

Prospector™ Oilfield 150

SAP #	ID		Nom. OD		Max. WP		Bend Radius		Vacuum HG	Weight	
	in.	mm	in.	mm	psi	MPa	in.	mm	in.	lb./ft.	kg/m
20018018	1	25.4	1.49	37.8	150	1.03	4.0	102	29	0.64	0.95
20018020	1 1/4	31.75	1.74	44.2	150	1.03	4.0	102	29	0.77	1.14
20018023	1 1/2	38.1	1.99	50.6	150	1.03	4.0	102	29	0.91	1.36
20018028	2	50.8	2.49	63.2	150	1.03	4.5	114	29	1.71	1.74
20018031	2 1/2	63.5	3.01	76.4	150	1.03	5.75	146	29	1.48	2.20
20018034	3	76.2	3.54	89.9	150	1.03	7.0	178	29	1.91	2.84
20018037	4	101.6	4.59	116.5	150	1.03	10.0	254	29	2.82	4.19
20018042	6	152.4	6.76	171.7	150	1.03	19.0	483	29	5.75	8.56

Air & Multipurpose

General Purpose
Heavy Duty
Push-on

Chemical Transfer

Cleaning Equipment

Food

Transfer
Washdown

Marine

Material Handling

Abrasives
Bulk Transfer
Cement & Concrete

Mining

Petroleum

Aircraft Fueling
Dispensing
Dock
Transfer

Spray

Steam

Vacuum

LPG Delivery

Water

Discharge
Suction & Discharge
Washdown

Welding

Coupling Systems

Equipment

Appendix

Prospector™ Oilfield 300



Air & Multipurpose

- General Purpose
- Heavy Duty
- Push-on

Chemical Transfer

Cleaning Equipment

- Food**
- Transfer
- Washdown

Marine

Material Handling

- Abrasives
- Bulk Transfer
- Cement & Concrete

Mining

Petroleum

- Aircraft Fueling
- Dispensing
- Dock
- Transfer

Spray

Steam

Vacuum

LPG Delivery

Water

- Discharge
- Suction & Discharge
- Washdown

Welding

Coupling Systems

Equipment

Appendix

Product Specifications

Application

Transfer of oil or liquid slurries.

Construction Tube

Nitrile

Cover

Black SBR

Reinforcement

Spiral-ply fabric with wire helix

Temperature Range

-35°F to 180°F (-37°C to 82°C)

Packaging

100' lengths, coiled and polywrapped

Branding (Spiral)

Example: Continental ContiTech Prospector™ Oilfield 300

Couplings

Contact fitting manufacturer for proper fitting recommendation and coupling procedure

Stock Length

100 ft

Order Codes

543-098

Rating

300 psi and full vacuum

Prospector™ Oilfield 300

SAP #	Nom ID		Nom. OD		Max. WP		Weight		Order Code
	in.	mm	in.	mm	psi	MPa	lb./ft.	kg/m	Black
20464301	2	51.1	2.5	64.3	300	2.07	1.21	0.17	543-098
20464302	3	76.1	3	90.8	300	2.07	1.97	0.27	
20464303	4	102.1	4.7	119.7	300	2.07	3.16	0.44	
20531361	5	127.4	5.9	150.3	300	2.07	5.34	0.74	
20464305	6	152.4	6.9	175.4	300	2.07	6.66	9.91	

LW Arctic Tank Truck



Product Specifications

Application

For transfer of petroleum-based products under suction, low-pressure discharge or gravity flow. Flexibility maintained down to -65°F (-54°C).

Construction Tube

Black Nitrile RMA Class A (High Oil Resistance)

Cover

Blue Wingprene® (corrugated)

Reinforcement

Spiral-plied synthetic fabric with double wire helix

Temperature Range

-65°F to 180°F (-54°C to 82°C)

Packaging

100' lengths, coiled and polywrapped

Branding (Spiral)

Example: Continental ContiTech LW Arctic Tank Truck 150 psi/10 Bar

Couplings

Contact fitting manufacturer for proper fitting recommendation and coupling procedure.

Order Codes

543-365

LW Arctic Tank Truck

SAP #	ID	Nom. OD		Max. WP		Bend Radius		Vacuum HG		Weight		
		in.	mm	in.	mm	in.	mm	in.	mm	lb./ft.	kg/m	
20017813	2	50.8	2.53	64.3	200	1.38	4	100	29	737	1.11	1.64
20117198	2½	63.5	3.02	76.7	150	1.03	5	125	29	737	1.42	2.11
20017814	3	76.2	3.55	90.2	150	1.03	6	150	29	737	1.83	2.72
20017815	4	101.6	4.61	117.1	150	1.03	9	225	29	737	2.62	3.90

Air & Multipurpose

General Purpose
Heavy Duty
Push-on

Chemical Transfer

Cleaning Equipment

Food

Transfer
Washdown

Marine

Material Handling

Abrasives
Bulk Transfer
Cement & Concrete

Mining

Petroleum

Aircraft Fueling
Dispensing
Dock
Transfer

Spray

Steam

Vacuum

LPG Delivery

Water

Discharge
Suction & Discharge
Washdown

Welding

Coupling Systems

Equipment

Appendix

Plicord® Arctic Flexwing™



Product Specifications

Air & Multipurpose

- General Purpose
- Heavy Duty
- Push-on

Chemical Transfer

Cleaning Equipment

- Food**
- Transfer
- Washdown

Marine

Material Handling

- Abrasives
- Bulk Transfer
- Cement & Concrete

Mining

Petroleum

- Aircraft Fueling
- Dispensing
- Dock
- Transfer

Spray

Steam

Vacuum

LPG Delivery

- Water**
- Discharge
- Suction & Discharge
- Washdown

Welding

Coupling Systems

Equipment

Appendix

Application

Plicord® Arctic Flexwing® is for use in low-temperature operations for transferring gasoline, oil and other petroleum products.

Construction Tube

Ultra-low temperature oil resistant synthetic rubber RMA Class A (High Oil Resistance)

Cover

Blue ultra-low temperature synthetic rubber RMA Class A (High Oil Resistance) with red spiral stripe. Smooth cover, wrapped finish

Reinforcement

Spiral-plied synthetic fabric with wire helix

Temperature Range

-65°F to 180°F (-54°C to 82°C)

Packaging

100' lengths, coiled and polywrapped

Branding (Spiral)

Example: Continental ContiTech Arctic Flexwing® 150 psi WP

Couplings

Use Continental ContiTech Insta-Lock™ Cam & Groove Fittings with this product. See the Coupling Systems information pages at the back of the catalog.

Order Codes

543-650

Plicord® Arctic Flexwing™

SAP #	ID		Nom. OD		Max. WP		Bend Radius		Vacuum HG		Weight	
	Blue	in.	mm	in.	mm	psi	MPa	in.	mm	in.	mm	lb./ft.
20017996	1¼	31.8	1.73	43.9	150	1.03	3	80	29	737	0.66	0.98
20017997	1½	38.1	1.98	50.3	150	1.03	4	102	29	737	0.82	1.22
20018001	2	50.8	2.50	63.5	150	1.03	5	127	29	737	1.07	1.59
20018002	2½	63.5	3.09	78.5	150	1.03	6	152	29	737	1.64	2.44
20018004	3	76.2	3.58	90.9	150	1.03	7	178	29	737	1.92	2.86
20018005	4	101.6	4.70	119.4	150	1.03	10	254	29	737	2.88	4.29

Plicord® Fuel Discharge



Product Specifications

Application

Plicord® Fuel Discharge hose is for the discharge of gasoline, oil, ethanol blends and other petroleum based products in tank and industrial applications.

Construction Tube

Nitrile synthetic rubber RMA Class A (High Oil Resistance), plus antistatic wires

Cover

Black Chemivic™ synthetic rubber RMA Class B (Medium-High Oil Resistance)

Reinforcement

Spiral-plied synthetic fabric (2"-4": 2 ply; 6": 4 ply), plus grounding wires

Temperature Range

-35°F to 180°F (-37°C to 82°C)

Plicord® Fuel Discharge

Order Codes: 543-123

SAP #	ID		Nom. OD		Max. WP		Weight	
	in.	mm	in.	mm	psi	MPa	lb./ft.	kg/m
20032339	3/4	19.1	1.21	30.7	150	1.03	0.42	0.63
20032357	1	25.4	1.46	37.1	150	1.03	0.52	0.77
20050546	1¼	31.8	1.72	43.7	150	1.03	0.63	0.94
20017756	1½	38.1	1.95	49.5	150	1.03	0.73	1.09
20017758	2	50.8	2.49	63.3	150	1.03	0.98	1.46
20032358	2½	63.5	2.98	75.7	150	1.03	1.19	1.77
20017764	3	76.2	3.50	88.9	150	1.03	1.45	2.16
20050547	3½	88.9	4.04	102.6	150	1.03	1.70	2.53
20017767	4	101.6	4.52	114.8	150	1.03	1.91	2.84
20126041	6	152.4	6.63	168.4	150	1.03	3.41	5.07

Packaging

100' length, coiled and polywrapped

Branding (Spiral)

Example: Continental ContiTech Plicord® Fuel Discharge

Couplings

Use Continental ContiTech Insta-Lock™ Cam & Groove Fittings with this product. See the Coupling Systems information pages at the back of the catalog.

Order Codes

543-331

Air & Multipurpose
General Purpose
Heavy Duty
Push-on

Chemical Transfer

Cleaning Equipment

Food
Transfer
Washdown

Marine

Material Handling
Abrasives
Bulk Transfer
Cement & Concrete

Mining

Petroleum
Aircraft Fueling
Dispensing
Dock
Transfer

Spray

Steam

Vacuum

LPG Delivery

Water
Discharge
Suction & Discharge
Washdown

Welding

Coupling Systems

Equipment

Appendix

Plicord® ExtremeFlex™ Petroleum Transfer



Air & Multipurpose
General Purpose
Heavy Duty
Push-on

Chemical Transfer

Cleaning Equipment

Food
Transfer
Washdown

Marine

Material Handling
Abrasives
Bulk Transfer
Cement & Concrete

Mining

Petroleum
Aircraft Fueling
Dispensing
Dock
Transfer

Spray

Steam

Vacuum

LPG Delivery

Water
Discharge
Suction & Discharge
Washdown

Welding

Coupling Systems

Equipment

Appendix

Product Specifications

Application

An extremely flexible and lightweight drop hose for use in tank truck and in-plant operation to transfer diesel, ethanol, gasoline, oil and petroleum base products up to 60% aromatic content. Corrugated construction for lower drag coefficient and superior abrasion resistance.

Construction Tube

Black Nitrile synthetic rubber (Class A oil resistance)

Cover

Black Chemivic™ synthetic (corrugated)

Reinforcement

Spiral plied synthetic fabric with wire helix

Temperature Range

-40°F to 200°F (-40°C to 93°C)

Packaging

100' lengths, coiled and bagel packed

Branding (Spiral)

Example: Plicord® ExtremeFlex™ Petroleum Transfer

Couplings

Use Continental ContiTech Insta-Lock™ Cam & Groove Fittings.

Order Codes

543-216

Plicord® ExtremeFlex™ Petroleum Transfer

SAP #	ID	Nom. OD		Max. WP		Bend Radius		Vacuum HG		Weight		
Black	in.	mm	in.	mm	psi	MPa	in.	mm	in.	mm	lb./ft.	kg/m
20459042	3/4	19.1	1.20	30.5	250	1.72	.75	19	29	737	0.44	0.65
20459043	1	25.4	1.45	36.8	250	1.72	1	25	29	737	0.55	0.81
20459044	1½	38.1	1.91	48.5	250	1.72	1.5	38	29	737	0.73	1.08
20459045	2	50.8	2.43	61.8	250	1.72	2	51	29	737	0.96	1.43
20459046	2½	63.5	3.00	76.1	200	1.37	2.5	64	29	737	1.41	2.10
20459047	3	76.2	3.50	88.8	200	1.37	3	76	29	737	1.69	2.51
20459048	4	101.6	4.56	115.7	150	1.03	4	101	29	737	2.42	3.61
20546328	6	152.4	6.62	168.4	150	1.03	6	146	29	737	4.43	2.01



Spiraflex® Polyurethane Vapor Recovery



Product Specifications

Application

For the recovery of gasoline vapors in tank truck loading at bulk terminals and in tank truck unloading at service stations.

Construction Tube

Transparent polyurethane

Cover

Transparent polyurethane

Reinforcement

Red rigid Pliovic® helix, available with static wire placed between the tube and cover

Temperature Range

-30°F to 150°F (-34°C to 66°C)

Packaging

100' lengths, coiled and polywrapped

Branding

Not branded

Couplings

Contact fitting manufacturer for proper fitting recommendation and coupling procedure.

Order Codes

586-465 (without static wire)
586-468 (static wire)

Spiraflex® Polyurethane Vapor Recovery

SAP #	ID		Nom. OD		Max. WP		Bend Radius		Weight			
	W/out Static Wire	Static Wire	in.	mm	in.	mm	psi	MPa	in.	mm	lb./ft.	kg/m
20562108	20013586		2	50.8	2.47	62.7	30	0.21	3	76	0.57	0.85
20013561	20013587		3	76.2	3.41	86.6	20	0.14	4	102	0.68	1.01
20013562	20013588		4	101.6	4.51	114.6	15	0.10	7	178	0.98	1.46

Air & Multipurpose

General Purpose
Heavy Duty
Push-on

Chemical Transfer

Cleaning Equipment

Food

Transfer
Washdown

Marine

Material Handling

Abrasives
Bulk Transfer
Cement & Concrete

Mining

Petroleum

Aircraft Fueling
Dispensing
Dock
Transfer

Spray

Steam

Vacuum

LPG Delivery

Water

Discharge
Suction & Discharge
Washdown

Welding

Coupling Systems

Equipment

Appendix

Pyroflex® Hot Tar & Asphalt II



Product Specifications

Air & Multipurpose

- General Purpose
- Heavy Duty
- Push-on

Chemical Transfer

Cleaning Equipment

- Food Transfer
- Washdown

Marine

Material Handling

- Abrasives
- Bulk Transfer
- Cement & Concrete

Mining

Petroleum

- Aircraft Fueling
- Dispensing
- Dock Transfer

Spray

Steam

Vacuum

LPG Delivery

Water

- Discharge
- Suction & Discharge
- Washdown

Welding

Coupling Systems

Equipment

Appendix

Application

For the transfer of high temperature petroleum-based materials such as tar, asphalt and hot oils. It is suitable for suction and discharge service on tank trucks, tank cars or at bulk stations. Heat resistant tube and aramid reinforcement. (Hot oils only rated to 200°F/93°C)

Construction Tube

Black Nitrile (special heat resistant) synthetic rubber RMA Class A (High Oil Resistance)

Cover

Black Wingprene® synthetic rubber RMA Class A (High Oil Resistance) with spiral red stripe

Reinforcement

Spiral-plied aramid with wire helix

Temperature Range

-25°F to 350°F (-32°C to 177°C)

Packaging

100' lengths, coiled and polywrapped

Branding (Spiral)

Example: Continental ContiTech Pyroflex® Hot Tar and Asphalt II 150 psi

Couplings

Contact fitting manufacturer for proper fitting recommendation and coupling procedure.

Order Codes

543-118

Pyroflex® Hot Tar & Asphalt II

SAP #	ID	Nom. OD		Max. WP		Bend Radius		Vacuum HG		Weight		
		in.	mm	in.	mm	in.	mm	in.	mm	lb./ft.	kg/m	
20017573	1½	38.1	2.08	52.8	150	1.03	4	102	29	737	1.04	1.55
20017574	2	50.8	2.60	66.0	150	1.03	5	127	29	737	1.33	1.98
20046059	2½	63.5	3.09	78.6	150	1.03	6	152	29	737	1.67	2.49
20017578	3	76.2	3.65	92.8	150	1.03	7	178	29	737	2.23	3.32
20017580	4	101.6	4.68	118.8	150	1.03	10	254	29	737	2.91	4.34

Pyroflex® Hot Tar Wand



Product Specifications

Application

A high-quality wand hose used in asphalt crack filling applicator and dispensing service.

Construction Tube

Black Nitrile (special heat resistance)

Cover

Black Wingprene® (wrapped finish) flame-retardant

Reinforcement

Spiral-plied (2) steel wire

Temperature Range

-25°F to 350°F (-32°C to 177°C)

Packaging

100' lengths, coiled and polywrapped

Branding (Spiral)

Example: Continental ContiTech Pyroflex® Hot Tar Wand Hose

Couplings

Contact fitting manufacturer for proper fitting recommendation and coupling procedure.

Order Codes

543-632

Pyroflex® Hot Tar Wand

SAP #	ID		Nom. OD		Max. WP		Weight	
	in.	mm	in.	mm	psi	MPa	lb./ft.	kg/m
20017982	3/4	19.1	1.33	33.8	300	2.07	0.64	0.95
20017987	1	25.4	1.61	40.9	300	2.07	0.84	1.25
20156594	1½	38.1	2.11	53.6	300	2.07	1.15	1.71

Air & Multipurpose

General Purpose
Heavy Duty
Push-on

Chemical Transfer

Cleaning Equipment

Food

Transfer
Washdown

Marine

Material Handling

Abrasives
Bulk Transfer
Cement & Concrete

Mining

Petroleum

Aircraft Fueling
Dispensing
Dock
Transfer

Spray

Steam

Vacuum

LPG Delivery

Water

Discharge
Suction & Discharge
Washdown

Welding

Coupling Systems

Equipment

Appendix

Alternative Fuel Compatibility For Tubes and Covers Of Continental ContiTech Fuel Transfer Hoses

Air & Multipurpose
General Purpose
Heavy Duty
Push-on

Chemical Transfer

Cleaning Equipment

Food
Transfer
Washdown

Marine

Material Handling
Abrasives
Bulk Transfer
Cement & Concrete

Mining

Petroleum
Aircraft Fueling
Dispensing
Dock
Transfer

Spray

Steam

Vacuum

LPG Delivery

Water
Discharge
Suction & Discharge
Washdown

Welding

Coupling Systems

Equipment

Appendix

Compatibility by Product

All Continental ContiTech Fuel Transfer Hoses are compatible with gasoline and diesel

Hose Tube & Cover Compatibility Ethanol & Biodiesel

Product	Product Code	Aromatic Content	E-100 100% Ethanol	E-85 85% Ethanol	E-15 15% Ethanol	B-100 100% Biodiesel	B-50 50% Biodiesel	B-20 20% Biodiesel
Infinity	543-773	60%	Tube & Cover	Tube & Cover	Tube & Cover	Tube & Cover	Tube & Cover	Tube & Cover
Infinity HD	543-138	60%	Tube & Cover	Tube & Cover	Tube & Cover	Tube & Cover	Tube & Cover	Tube & Cover
Infinity HD LT	543-663	60%	Tube & Cover	Tube & Cover	Tube & Cover	No	No	No
Flexwing VersaFuel	543-422	60%	Tube & Cover	Tube & Cover	Tube & Cover	Tube & Cover	Tube & Cover	Tube & Cover
Flexwing VersaFuel Flex	543-636	60%	Tube & Cover	Tube & Cover	Tube & Cover	Tube & Cover	Tube & Cover	Tube & Cover
Plicord ExtremeFlex	543-216	60%	Tube & Cover	Tube & Cover	Tube & Cover	No	No	No
Plicord Flexwing Petroleum	543-109	60%	Tube & Cover	Tube & Cover	Tube & Cover	No	No	No
Red Flextra	543-123, 543-120	60%	Tube & Cover	Tube & Cover	Tube & Cover	No	No	No
Paladin	543-227	60%	Tube & Cover	Tube & Cover	Tube & Cover	Tube & Cover	Tube & Cover	Tube & Cover
Plicord Super Black Flexwing®	543-117	60%	Tube & Cover	Tube & Cover	Tube & Cover	No	No	No
Plicord LW Black Flextra II	543-562	50%	Tube & Cover	Tube & Cover	Tube & Cover	No	No	No
Plicord Arctic Flexwing	543-650	50%	Tube & Cover	Tube & Cover	No	No	No	No
LW Arctic Tank Truck	543-365	50%	Tube & Cover	Tube & Cover	No	No	No	No

Spray



	Page	Rubber	Thermoplastic	Textile	Wire	Temp. Range	MSHA
Mine Spray	148	Yes			Yes	0°F to 212°F	Yes
NR Spray	217	Yes		Yes		0°F to 190°F	
Pliovic® Ag Spray (1800 & 2400)	218		Yes	Yes		0°F to 158°F	

Air & Multipurpose

General Purpose
Heavy Duty
Push-on

Chemical Transfer

Cleaning Equipment

Food

Transfer
Washdown

Marine

Material Handling

Abrasives
Bulk Transfer
Cement & Concrete

Mining

Petroleum

Aircraft Fueling
Dispensing
Dock
Transfer

Spray

Steam

Vacuum

LPG Delivery

Water

Discharge
Suction & Discharge
Washdown

Welding

Coupling Systems

Equipment

Appendix

NR Spray



Air & Multipurpose

General Purpose
Heavy Duty
Push-on

Chemical Transfer

Cleaning Equipment

Food
Transfer
Washdown

Marine

Material Handling
Abrasives
Bulk Transfer
Cement & Concrete

Mining

Petroleum
Aircraft Fueling
Dispensing
Dock
Transfer

Spray

Steam

Vacuum

LPG Delivery

Water
Discharge
Suction & Discharge
Washdown

Welding

Coupling Systems

Equipment

Appendix

Product Specifications

Application

NR Spray is a premium-quality, all-purpose hose for handling a variety of applications such as paint spray or agricultural spray. Will handle spraying paints, automotive finish paints, lacquers, thinners, turpentine, air, oil and a large variety of solvents and chemicals.

Construction Tube

Nylon, silicone-free

Cover

Black synthetic rubber, RMA Class B (Medium Oil Resistance)

Reinforcement

Braided synthetic yarn (1/4" and 3/8"-1 braid) (1/2", 3/4" and 1"-2 braid)

Temperature Range

0°F to 190°F (-18°C to 88°C)

Packaging

500' reel, maximum 3 pieces, 50' minimum

Branding

Example: Continental ContiTech 1/4" IBD NR Spray. Made in U.S.A.

Couplings

Contact fitting manufacturer for proper fitting recommendation and coupling procedure.

Order Codes

536-290

NR Spray

SAP #	ID		Nom. OD		Max. WP		Weight	
	in.	mm	in.	mm	psi	MPa	lb./ft.	kg/m
20022944	1/4	6.4	0.49	12.4	750	5.17	0.08	0.12
20106900	5/16	7.9	0.61	15.5	750	5.17	0.13	0.19
20022951	3/8	9.5	0.70	17.8	750	5.17	0.15	0.22
20022962	1/2	12.7	0.87	22.1	750	5.17	0.22	0.33
20022967	5/8	15.9	1.05	26.7	750	5.17	0.31	0.46
20022969	3/4	19.1	1.19	30.2	750	5.17	0.36	0.54
20022976	1	25.4	1.51	38.4	750	5.17	0.54	0.80

Pliovic® AG Spray

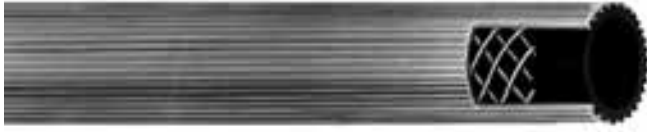

Product Specifications

Application

A lightweight, economical high-pressure hose for carrying air, water and many spray solutions in agricultural applications: including Xylene up to 10% concentration. Safety factor 3:1.

Construction Tube

Pliovic® RMA Class B (Medium Oil Resistance)

Cover

Orange or green Pliovic® (ribbed finish)

Reinforcement

Spiral synthetic yarn

Temperature Range

0°F to 158°F (-18°C to 70°C)

Pliovic® 1800 (Orange)

Order Codes: 540-211

SAP #	ID		Nom. OD		Max. WP		Weight	
	in.	mm	in.	mm	psi	MPa	lb./ft.	kg/m
20012638	3/8	9.5	0.69	17.5	600	4.14	0.14	0.21
20012641	1/2	12.7	0.78	19.8	600	4.14	0.19	0.28
20012643	3/4	19.1	1.10	27.9	600	4.14	0.28	0.42

Pliovic® 2400 (Green)

Order Codes: 540-208

SAP #	ID		Nom. OD		Max. WP		Weight	
	in.	mm	in.	mm	psi	MPa	lb./ft.	kg/m
20012626	3/8	9.5	0.70	17.8	800	5.52	0.14	0.21
20012632	1/2	12.7	0.85	21.6	800	5.52	0.20	0.30
20012635	3/4	19.1	1.10	27.9	800	5.52	0.28	0.42

Packaging

300' length, coiled and polywrapped

Branding

Example: Continental ContiTech Pliovic® 1800 Spray 1/2" (12.7mm). Made in U.S.A.

Couplings

Contact fitting manufacturer for proper fitting recommendation and coupling procedure.

Air & Multipurpose

General Purpose
Heavy Duty
Push-on

Chemical Transfer

Cleaning Equipment

Food Transfer Washdown

Marine

Material Handling

Abrasives
Bulk Transfer
Cement & Concrete

Mining

Petroleum

Aircraft Fueling
Dispensing
Dock
Transfer

Spray

Steam

Vacuum

LPG Delivery

Water

Discharge
Suction & Discharge
Washdown

Welding

Coupling Systems

Equipment

Appendix

Steam



Air & Multipurpose
 General Purpose
 Heavy Duty
 Push-on

Chemical Transfer

Cleaning Equipment

Food
 Transfer
 Washdown

Marine

Material Handling
 Abrasives
 Bulk Transfer
 Cement & Concrete

Mining

Petroleum
 Aircraft Fueling
 Dispensing
 Dock
 Transfer

Spray

Steam

Vacuum

LPG Delivery

Water
 Discharge
 Suction & Discharge
 Washdown

Welding

Coupling Systems

Equipment

Appendix

	Page	Temp. Range	Smooth Cover	Wrapped Cover	Colors	Crimped Assembly
Crimped Steam Assembly	225	-40°F to 450°F	Yes	Yes	Red/Black	Yes
Flexsteel 250 CB Extreme	224	-40°F to 425°F		Yes	Red/Black	Yes
Flexsteel 250 CB Steam	223	-40°F to 425°F		Yes	Red/Black	
Flexsteel 250 EPDM-20	222	-40°F to 450°F		Yes	Red	Yes
Flexsteel 250 Steam	221	-40°F to 450°F	Yes	Yes	Red/Black	Yes
Heavy Duty Steam Pile Driver	220	-40°F to 406°F		Yes	Red/Black	
MIL-DTL-29210E Steam	228	0°F to 406°F		Yes	Black	
Plicord® 250 Steam	226	0°F to 406°F		Yes	Red/Black	

Heavy Duty Steam Pile Driver



Product Specifications

Application

Designed to withstand the toughest off-shore pile driving applications and offer long-lasting service in on shore applications. A combination of the steam-resistant EPDM tubing plus the steel aramid construction gives this hose the pliability and kinetic and crush resistance required in this application.

Construction Tube

Black EPDM synthetic rubber

Cover

Red or black EPDM synthetic rubber

Reinforcement

Brass-coated steel cord and aramid breakers

Temperature Range

-40°F to 406°F (-40°C to 205°C)

Packaging

100' exact length, coiled and polywrapped

Branding (Spiral)

Example: Continental ContiTech H.D. Steam Pile Driver 250 psi WP

Couplings

Contact fitting manufacturer for proper fitting recommendation and coupling procedure

Order Codes

541-461 (black)
541-460 (red)

Heavy Duty Steam Pile Driver

SAP #		ID	Nom. OD		Max. WP		Bend Radius		Weight		
Black	Red	in.	mm	in.	mm	psi	MPa	in.	mm	lb./ft.	kg/m
20196602		3	76.2	4.29	109.0	250	1.72	24	610	4.90	7.29
20252985	20214787	4	101.6	5.63	143.0	250	1.72	32	813	9.07	13.50
20525522		6	152.4	7.66	194.6	250	1.72	48	1200	10.98	16.4

Air & Multipurpose
General Purpose
Heavy Duty
Push-on

Chemical Transfer

Cleaning Equipment

Food
Transfer
Washdown

Marine

Material Handling
Abrasives
Bulk Transfer
Cement & Concrete

Mining

Petroleum
Aircraft Fueling
Dispensing
Dock
Transfer

Spray

Steam

Vacuum

LPG Delivery

Water
Discharge
Suction & Discharge
Washdown

Welding

Coupling Systems

Equipment

Appendix

Flexsteel® 250 Steam



Air & Multipurpose
 General Purpose
 Heavy Duty
 Push-on

Chemical Transfer

Cleaning Equipment

Food
 Transfer
 Washdown

Marine

Material Handling
 Abrasives
 Bulk Transfer
 Cement & Concrete

Mining

Petroleum
 Aircraft Fueling
 Dispensing
 Dock
 Transfer

Spray

Steam

Vacuum

LPG Delivery

Water
 Discharge
 Suction & Discharge
 Washdown

Welding

Coupling Systems

Equipment

Appendix

Product Specifications

Application

For cleaning, heat control, fire prevention, pumping, thawing, blow-out service, steam pumps and hoists in open-end or permanent installation operations. It is used in refineries, shipyards, chemical plants, steel mills, foundries and heavy industrial applications where high strength is required and where severe environmental conditions are encountered.

Construction Tube

Pyrosyn® synthetic rubber

Cover

Black or red Pyrosyn finish, pin-pricked

Reinforcement

Braided steel wire (3/4" and 1" have 2 steel wire braids)

Temperature Range

-40°F to 450°F (-40°C to 232°C)

Packaging

Reels or 50' cut lengths (1/2" - 4 per box, 3/4" - 3 per box, 1" - 2 per box)

Branding

Example: Continental ContiTech Flexsteel® 250 Steam Max WP 250 psi. Made in U.S.A.

Couplings

See Continental ContiTech Hose Assembly Manual for most current crimp solutions.

Order Codes

539-070 (black)
 539-076 (red)
 539-470 (black wrapped)
 539-476 (red wrapped)

Flexsteel® 250 Steam

SAP #	ID				Nom. OD		Max. WP		Weight		
	Black	Red	Black Wrapped	Red Wrapped	in.	mm	in.	mm	psi	MPa	lb./ft.
20023390	20136859	20575082	20767531	1/2	12.7	1.06	26.9	250	1.72	0.45	0.67
20023401	20023462	20757055	20757277	3/4	19.1	1.28	32.5	250	1.72	0.56	0.83
20023419	20024994	20760526	20590425	1	25.4	1.63	41.4	250	1.72	0.91	1.35
		20615488	20620044	1 1/4	31.8	1.88	47.8	250	1.72	1.02	1.52
		20575082	20620048	1 1/2	38.1	2.12	53.8	250	1.72	1.23	1.830
		20617154	20620060	2	50.8	2.70	68.6	250	1.72	1.79	2.66

Flexsteel® 250 EPDM-20



Product Specifications

Application

The Flexsteel® 250 EPDM-20 features the superior performance of Flexsteel 250 Steam hose series enhanced with the increased safety factor of 20:1. This exceeds the RMA safety standard and makes steam operations more secure and user friendly. The hose has a maximum operating pressure of 250 psi with a temperature range of -40°F to 450°F.

Construction Tube

Pyrosyn® synthetic rubber

Cover

Red Wrapped Pyrosyn®, pin-pricked

Reinforcement

Braided steel wire (3/4" and larger have 2 steel wire braids)

Temperature Range

-40°F to 450°F (-40°C to 232°C)

Packaging

Bulk, cut lengths, coupled assemblies

Branding

Example: Continental ContiTech Flexsteel® 250 EPDM-20 Steam 250 psi. Made in U.S.A.

Couplings

See Continental ContiTech Hose Assembly Manual for most current crimp solutions.

Order Codes

539-486

Flexsteel® 250 EPDM-20

SAP #	ID		Nom. OD		Max. WP		Weight	
	in.	mm	in.	mm	psi	MPa	lb./ft.	kg/m
20559161	3/4	19.1	1.28	32.5	250	1.72	0.59	0.83
20736602	1	25.4	1.63	41.4	250	1.72	0.95	1.43

Air & Multipurpose

General Purpose
Heavy Duty
Push-on

Chemical Transfer

Cleaning Equipment

Food

Transfer
Washdown

Marine

Material Handling

Abrasives
Bulk Transfer
Cement & Concrete

Mining

Petroleum

Aircraft Fueling
Dispensing
Dock
Transfer

Spray

Steam

Vacuum

LPG Delivery

Water

Discharge
Suction & Discharge
Washdown

Welding

Coupling Systems

Equipment

Appendix

Flexsteel® 250 CB Steam



Air & Multipurpose
 General Purpose
 Heavy Duty
 Push-on

Chemical Transfer

Cleaning Equipment

Food
 Transfer
 Washdown

Marine

Material Handling
 Abrasives
 Bulk Transfer
 Cement & Concrete

Mining

Petroleum
 Aircraft Fueling
 Dispensing
 Dock
 Transfer

Spray

Steam

Vacuum

LPG Delivery

Water
 Discharge
 Suction & Discharge
 Washdown

Welding

Coupling Systems

Equipment

Appendix

Product Specifications

Application

Used for cleaning, heat control, fire prevention, pumping, thawing, blowout service, steam pumps and hoists in open-end or permanent installation operations. It is used in refineries, shipyards, chemical plants, steel mills, foundries and heavy industrial applications where high strength is required and where severe environmental conditions are encountered.

Construction Tube

Chlorobutyl synthetic rubber

Cover

Red or black Pyrosyn® synthetic rubber

Reinforcement

Braided steel wire (3/4" and higher have 2 steel wire braids)

Temperature Range

-40°F to 425°F (-40°C to 218°C)

Packaging

Wrapped cover:

1/2" - Four 50' exact length/box

3/4"-1" - Three 50' exact length/box

1¼"-2" - One 50' exact length/box

Branding

Example: Continental ContiTech Flexsteel® 250 CB Steam Max WP 250 psi. Made in U.S.A.

Couplings

Contact fitting manufacturer for proper fitting recommendation and coupling procedure.

Flexsteel® 250 CB Steam WF - Wrapped Finish

Order Codes: 1/2"-1" 539-176 (red) 1¼"-2" 581-176 (red) 1/2"-1" 539-170 (black)

SAP #	ID		Nom. OD		Max. WP		Weight			
	Red	Black	in.	mm	in.	mm	psi	MPa	lb./ft.	kg/m
20050829			1/2	12.7	1.00	25.4	250	1.72	0.40	0.60
20024094	20050195		3/4	19.1	1.31	33.3	250	1.72	0.64	0.95
20045991			1	25.4	1.56	39.6	250	1.72	0.77	1.15
20045770			1¼	31.8	1.75	44.5	250	1.72	1.06	1.58
20046224			1½	38.1	2.00	50.8	250	1.72	1.42	2.11
20046225			2	50.8	2.50	63.5	250	1.72	1.71	2.54

Flexsteel® 250 CB Extreme Crimp Steam Hose



Product Specifications

Application

ContiTech is pleased to announce the Flexsteel® 250 CB Extreme Crimp Steam Hose, the only ContiTech chlorobutyl steam hose with an enhanced over-the-cover crimp coupling solution. The hose is rated to a maximum operating pressure of 250 psi, and its temperature range is -40°F to 425°F (-40°C to 218°C), up to 450°F intermittent, with a 10:1 safety factor. And it is the only ContiTech chlorobutyl steam hose with a crimp solution.

Construction Tube

Chlorobutyl synthetic rubber

Cover

Red or black Pyrosyn®, pin-pricked

Temperature Range

-40°F to 425°F (-40°C to 218°C), up to 450°F intermittent

Packaging

Reels, cut lengths and coupled assemblies

Branding

Example: Continental ContiTech Flexsteel® 250 CB Extreme Crimp Steam. Drain after using. Made in U.S.A.

Material Code

539-870-024 (black)

539-876-024 (red)

Flexsteel 250 CB Extreme Crimp Steam Hose

SAP #		ID		OD		Max. WP		Weight	
Black	Red	in.	mm	in.	mm	psi	MPa	lb./ft.	kg/m
20637404	20645689	3/4	19.1	1.28	32.5	250	1.72	250	1.72

Hose ID	Cambell Viton Profile	Ground Sea Setting Low Nut	Joint Viton Seal Spud	Ground Female NPT Wing Nut	Campbell Male NPT	Joint Male NPT Swivel	Crimp Diameter	Die Set	Approx. Setting
3/4	RGJF-3V		GJF-3V		IMS-3V	IMS-3VSW	1.43	36	0.32

Air & Multipurpose

General Purpose
Heavy Duty
Push-on

Chemical Transfer

Cleaning Equipment

Food

Transfer
Washdown

Marine

Material Handling

Abrasives
Bulk Transfer
Cement & Concrete

Mining

Petroleum

Aircraft Fueling
Dispensing
Dock
Transfer

Spray

Steam

Vacuum

LPG Delivery

Water

Discharge
Suction & Discharge
Washdown

Welding

Coupling Systems

Equipment

Appendix

Crimped Steam Assembly



Product Specifications

Application

Coupling assembly crimps permanently onto hose; forms a tight crimp that reduces leaks and eliminates bulky bolt clamps while reducing potential for damage from snagging on personnel or property.

Recommended Crimp Diameters for Continental ContiTech Branded Steam Hose

Hose Description	Hose Product Code	Hose ID	Female Ground Joint Low Profile Unit	Female Ground Joint Wing Nut	Male NPT	Male NPT Swivel	Female Spud	Crimp Dia.	Continental ContiTech Perma-Crimp	Approx. Die Set	Approx. Setting
Flexsteel 250 (Black)	539-070-024	3/4"	RGJS-3V	GJS-3V	IMS-3V	IMS-3VSW	GFS-3	1.440"	34		2.6
Flexsteel 250 (Red)	539-076-024	3/4"	RGJS-3V	GJS-3V	IMS-3V	IMS-3VSW	GFS-3	1.440"	34		2.6
Flexsteel 250 (Black)	539-070-032	1"	RGJS-4V	GJS-4V	IMS-4V	IMS-4VSW	GFS-4	1.925"	45		3.9
Flexsteel 250 (Red)*	539-076-032	1"	RGN-4*	GN-4*	IMS-4G*	N/A	GFS-4	1.660**	41		1.16
Flexsteel 250 (Red Wrapped)	536-476-024	3/4"	RGJS-3V	GJS-3V	IMS-3V	IMS-3VSW	GFS-3	1.440"	34		2.6
Flexsteel 250 CB Extreme (Black, Red)	539-870-024 539-876-024	3/4"	RGJF-3V	GJF-3V	IMS-3V	IMS-3VSW	GFS-3	1.430"	34		2.32
Flexsteel 250 EPDM 20 (Red)	539-486-024	3/4"	RGJS-3V	GJS-3V	IMS-3V	IMS-3VSW	GFS-3	1.420"	34		2.1

*For the 2-piece skived fitting solution with SCF-4G ferrule, use GJS-4G NC stem for ground joint fittings. Skive length 1.555".

Female Wing Nut



Female Wing Nut with Female NPT Spud



Male NPT Swivel



Available as Male NPT

Female Low Profile Nut with Female NPT Spud



Air & Multipurpose

- General Purpose
- Heavy Duty
- Push-on

Chemical Transfer

Cleaning Equipment

- Food Transfer
- Washdown

Marine

Material Handling

- Abrasives
- Bulk Transfer
- Cement & Concrete

Mining

Petroleum

- Aircraft Fueling
- Dispensing
- Dock Transfer

Spray

Steam

Vacuum

LPG Delivery

Water

- Discharge
- Suction & Discharge
- Washdown

Welding

Coupling Systems

Equipment

Appendix

Plicord® 250 Steam



Product Specifications

Application

A rugged construction used for all-around steam service in chemical plants, refineries, shipyards and demanding industrial service. It is recommended for cleaning, thawing, blowout service, steam pumps, hoists and other applications involving steam.

Construction Tube

Black EPDM synthetic rubber

Cover

Black EPDM synthetic rubber, also available in red cover with yellow brand for color coding (wrapped impression)

Reinforcement

Spiral-plied steel wire

Temperature Range

0°F to 406°F (-18°C to 208°C)

Packaging

50' lengths, coiled and polywrapped

Branding (Spiral)

Example: Continental ContiTech Plicord® 250 Steam psi. Drain after use

Couplings

Contact fitting manufacturer for proper fitting recommendation and coupling procedure.

Order Codes

549-060 (black)
549-061 (red)

Plicord® 250 Steam

SAP#		ID		Nom. OD		Max. WP		Weight	
Black	Red	in.	mm	in.	mm	psi	MPa	lb./ft.	kg/m
20019132	20019162	1/2	12.7	0.97	24.6	250	1.72	0.33	0.49
20019137	20019168	3/4	19.1	1.25	31.8	250	1.72	0.49	0.73
20019141	20019174	1	25.4	1.50	38.1	250	1.72	0.61	0.91
20019144	20019178	1¼	31.8	1.81	46.0	250	1.72	0.83	1.24
20019148	20019180	1½	38.1	2.09	53.1	250	1.72	1.03	1.53
20019154	20019184	2	50.8	2.78	70.6	250	1.72	1.88	2.80
20019155	20019186	2½	63.5	3.28	83.3	250	1.72	2.33	3.47
20019158	20019187	3	76.2	3.77	95.8	250	1.72	2.73	4.06

Air & Multipurpose

General Purpose
Heavy Duty
Push-on

Chemical Transfer

Cleaning Equipment

Food

Transfer
Washdown

Marine

Material Handling

Abrasives
Bulk Transfer
Cement & Concrete

Mining

Petroleum

Aircraft Fueling
Dispensing
Dock
Transfer

Spray

Steam

Vacuum

LPG Delivery

Water

Discharge
Suction & Discharge
Washdown

Welding

Coupling Systems

Equipment

Appendix

Hydrocarbon Drain Hose®



Air & Multipurpose

- General Purpose
- Heavy Duty
- Push-on

Chemical Transfer

Cleaning Equipment

Food

- Transfer
- Washdown

Marine

Material Handling

- Abrasives
- Bulk Transfer
- Cement & Concrete

Mining

Petroleum

- Aircraft Fueling
- Dispensing
- Dock Transfer

Spray

Steam

Vacuum

LPG Delivery

Water

- Discharge
- Suction & Discharge
- Washdown

Welding

Coupling Systems

Equipment

Appendix

Product Specifications

Application

Heavy Duty hose designed for use in hydrocarbon drain service.

Construction Tube

Black Nitrile

Cover

Blue Wingprene

Reinforcement

Spiral Piled two steel wires

Temperature Range

-25°F to 350°F (-32°C to 177°C)

Packaging

100' Lengths, coiled and polywrapped

Branding

Continental ContiTech Hydrocarbon Drain Hose 300 PSI

Couplings

Contact fitting manufacturer for proper fitting recommendation and coupling procedure

Order Code

543-729

Hydrocarbon Drain Hose®

SAP#	ID		OD		Max. WP	Weight
	in.	mm	in.	mm	psi	lb./ft.
20264356	3/4	19.1	1.33	33.86	300	0.63
20467694	1	25.4	1.58	40.14	300	0.78
20326679	1 1/2	38.1	2.25	57.2	300	1.57
20276441	2	50.8	2.77	70.36	300	2.01

MIL-DTL-29210E Steam Hose

Updates to new “E” Specification



Product Specifications

Application

Hose assembly for military applications (such as Navy shipyard use) in temporary services from docks or barges to ships. First Article-approved hose meeting the requirements of MIL-DTL-29210 rev. E. This specification covers metal-lined, wire-reinforced, rubber hose assemblies for conveyance of saturated steam.*

Revision E update (key changes):

- › Ozone and steam tests as part of conformance testing are required for 1st Article in rev. E
- › Part or identifying number (PIN) is much more specific
- › The branding requirements have been corrected to brand as MIL-DTL-29210 instead of MIL-PRF-29210C.

Construction Tube

EPDM

Cover

Black wrapped finish EPDM

Reinforcement

2 wire braids

MIL-DTL-29210E Steam Hose

SAP #	ID	Nom. OD		Max. WP		Weight	
		in.	mm	psi	MPa	lb./ft.	kg/m
20490435	3/4	19.05	33.40	250	1.723	0.61	0.91
20453479	1	25.4	40.89	250	1.723	0.82	1.22
20469264	1½	38.1	53.85	250	1.723	1.22	1.82
20458670	2	50.8	68.83	250	1.723	1.80	2.68

*Steel liners are not available through Continental ContiTech. Please refer to Mil Spec for approved suppliers list.

Temperature Range

0° to 406°F (-18°C to 208°C)

Packaging

25' or 50' cut lengths

Branding

Continental ContiTech (Quarter/Year Date Code)
MIL-DTL-29210 250 PSIG (1724 KPA (Gauge)) steam 29210E

Couplings

End fittings and special stem design per MIL-DTL-29210E for use with stainless-steel metal liner.* Stainless-steel metal liner per MIL-DTL-29210E

Non Stock/Sizes

¾", 1", 1¼", 1½", 2" (*in development)

Order Codes

539-670

Air & Multipurpose

General Purpose
Heavy Duty
Push-on

Chemical Transfer

Cleaning Equipment

Food

Transfer
Washdown

Marine

Material Handling

Abrasives
Bulk Transfer
Cement & Concrete

Mining

Petroleum

Aircraft Fueling
Dispensing
Dock
Transfer

Spray

Steam

Vacuum

LPG Delivery

Water

Discharge
Suction & Discharge
Washdown

Welding

Coupling Systems

Equipment

Appendix

Notes

Air & Multipurpose

- General Purpose
- Heavy Duty
- Push-on

Chemical Transfer

Cleaning Equipment

Food

- Transfer
- Washdown

Marine

Material Handling

- Abrasives
- Bulk Transfer
- Cement & Concrete

Mining

Petroleum

- Aircraft Fueling
- Dispensing
- Dock
- Transfer

Spray

Steam

Vacuum

LPG Delivery

Water

- Discharge
- Suction & Discharge
- Washdown

Welding

Coupling Systems

Equipment

Appendix

Vacuum



	Page	Rubber	Thermoplastic	Clear	Corrugated Cover	Lightweight	Temp. Range
Arvac SW	117		Yes		Yes	Yes	-40°F to 158°F
Plicord HD Industrial Vacuum	234	Yes			Yes		-40°F to 180°F
Plicord Vacuum (HD & LW)	235	Yes			Yes	Yes	-25°F to 180°F
Spiraflex Ducting	232		Yes		Yes	Yes	0°F to 150°F
Spiraflex Grassvac	231		Yes	Yes	Yes	Yes	0°F to 158°F
Spiraflex Vacuum	233		Yes		Yes	Yes	0°F to 158°F
Spirathane HD	128		Yes		Yes	Yes	0°F to 158°F
Spirathane LD	130		Yes	Yes	Yes	Yes	0°F to 158°F
Spirathane PT	129		Yes	Yes	Yes	Yes	0°F to 158°F

Air & Multipurpose

General Purpose
Heavy Duty
Push-on

Chemical Transfer

Cleaning Equipment

Food

Transfer
Washdown

Marine

Material Handling

Abrasives
Bulk Transfer
Cement & Concrete

Mining

Petroleum

Aircraft Fueling
Dispensing
Dock
Transfer

Spray

Steam

Vacuum

LPG Delivery

Water

Discharge
Suction & Discharge
Washdown

Welding

Coupling Systems

Equipment

Appendix

Spiraflex® Grassvac™



Product Specifications

Application

For lawn, leaf, mulch and yard waste collection. It is also suitable for dust control, ventilation and ducting.

Construction Tube

Clear Pliovic®

Reinforcement

Black rigid, high-density Pliovic helix

Temperature Range

0°F to 158°F (-18°C to 70°C)

Packaging

4-6' - 100' lengths, coiled and polywrapped
7-8' - 50' lengths, coiled and polywrapped

Branding

Not branded

Couplings

Contact fitting manufacturer for proper fitting recommendation and coupling procedure.

Non Stock/Sizes

Available in all black construction.

Order Codes

586-429 (clear web, black helix)

Spiraflex® Grassvac™

SAP #	ID	Nom. OD		Max. WP		Bend Radius		Vacuum HG		Weight		
		in.	mm	psi	MPa	in.	mm	in.	mm	lb./ft.	kg/m	
20013384	4	101.6	4.46	113.3	15	0.10	4	102	15	381	0.71	1.06
20013385	5	127.0	5.55	141.0	15	0.10	7	178	15	381	1.07	1.59
20013388	6	152.4	6.56	166.6	10	0.07	7	178	15	381	1.43	2.13
20131290	7	177.8	7.63	193.8	10	0.07	9	229	15	381	1.75	2.60
20013390	8	203.2	8.66	220.0	10	0.07	9	229	15	381	2.06	3.07

Air & Multipurpose

- General Purpose
- Heavy Duty
- Push-on

Chemical Transfer

Cleaning Equipment

- Food**
- Transfer
- Washdown

Marine

Material Handling

- Abrasives
- Bulk Transfer
- Cement & Concrete

Mining

Petroleum

- Aircraft Fueling
- Dispensing
- Dock
- Transfer

Spray

Steam

Vacuum

LPG Delivery

- Water**
- Discharge
- Suction & Discharge
- Washdown

Welding

Coupling Systems

Equipment

Appendix

Spiraflex® Ducting



Product Specifications

Application

Versatile enough for use in leaf collection machines, manhole blowers and air conditioning and heating applications, as well as for air ducting and pollution control devices. Do not use Spiraflex® Ducting for pressure service.

Construction Tube

Metallic green Pliovic® synthetic compound

Reinforcement

Rigid white high-density Pliovic® helix

Temperature Range

0°F to 150°F (-18°C to 66°C)

Packaging

1" - 6" - 100' lengths, coiled and polywrapped
8" - 30' lengths, polywrapped

Branding

Not branded

Couplings

Contact fitting manufacturer for proper fitting recommendation and coupling procedure.

Order Codes

586-408

Spiraflex® Ducting

SAP #	ID		Nom. OD		Bend Radius		Weight	
	in.	mm	in.	mm	in.	mm	lb./ft.	kg/m
20013152	1	25.4	1.21	30.7	2	33	0.13	0.19
20013153	1¼	31.8	1.50	38.1	2	51	0.18	0.27
20013157	1½	38.1	1.74	44.2	2	52	0.22	0.33
20013158	2	50.8	2.30	58.4	3	76	0.28	0.42
20013159	2½	63.5	2.80	71.1	4	102	0.31	0.46
20013160	3	76.2	3.40	86.4	7	160	0.53	0.79
20013161	4	101.6	4.44	112.8	8	191	0.60	0.89
20013162	5	127.0	5.50	139.7	9	229	0.90	1.34
20013168	6	152.4	6.46	164.1	10	254	1.04	1.55
20013170	8	203.2	8.52	216.4	12	305	1.60	2.38

Air & Multipurpose

General Purpose
Heavy Duty
Push-on

Chemical Transfer

Cleaning Equipment

Food Transfer Washdown

Marine

Material Handling Abrasives Bulk Transfer Cement & Concrete

Mining

Petroleum Aircraft Fueling Dispensing Dock Transfer

Spray

Steam

Vacuum

LPG Delivery

Water Discharge Suction & Discharge Washdown

Welding

Coupling Systems

Equipment

Appendix

Spiraflex® Vacuum



Product Specifications

Application

Spiraflex® Vacuum hose is for dust collection and exhaust transmission where airborne pollutants, fumes and odors are a major problem.

Construction Tube

White Pliovic® compound

Reinforcement

Rigid white high-density Pliovic® helix

Temperature Range

0°F to 158°F (-18°C to 70°C)

Packaging

1"-4" - 100' lengths, coiled and polywrapped

5"-6" - 30' lengths, coiled and polywrapped

Branding

Not branded

Couplings

Contact fitting manufacturer for proper fitting recommendation and coupling procedure.

Order Codes

586-403

Spiraflex® Vacuum

SAP #	ID	Nom. OD		Max. WP		Vacuum HG		Bend Radius		Weight		
White	in.	mm	in.	mm	psi	MPa	psi	MP	in.	mm	lb./ft.	kg/m
20013089	1	25.4	1.22	31.0	37	0.26	3	64	29	737	0.13	0.19
20013090	1¼	31.8	1.50	38.1	37	0.26	4	84	29	737	0.24	0.36
20013092	1½	38.1	1.76	44.7	34	0.23	4	97	29	737	0.29	0.43
20013094	2	50.8	2.35	59.7	30	0.21	6	140	29	737	0.45	0.67
20013095	2½	63.5	2.87	72.9	30	0.21	7	178	29	737	0.61	0.91
20013096	3	76.2	3.42	86.9	30	0.21	8	203	29	737	0.80	1.19
20013097	4	101.6	4.53	115.1	27	0.19	14	356	15	381	1.13	1.68
20220897	5	127.0	5.50	139.7	25	0.17	20	508	10	254	1.07	1.59
20013099	6	152.4	6.59	167.4	20	0.14	25	635	10	254	2.05	3.05

Air & Multipurpose

- General Purpose
- Heavy Duty
- Push-on

Chemical Transfer

Cleaning Equipment

- Food Transfer
- Washdown

Marine

Material Handling

- Abrasives
- Bulk Transfer
- Cement & Concrete

Mining

Petroleum

- Aircraft Fueling
- Dispensing
- Dock Transfer

Spray

Steam

Vacuum

LPG Delivery

Water

- Discharge
- Suction & Discharge
- Washdown

Welding

Coupling Systems

Equipment

Appendix

Plicord® HD Industrial Vacuum



Product Specifications

Application

For handling exhaust acid fumes as well as abrasive dust from metal, rock, marble and wood grinding machines.

Construction Tube

3/16" Gauge Tan Pureten™ rubber

Cover

Black SBR synthetic rubber (corrugated)

Reinforcement

Spiral-plied synthetic fabric with double wire helix

Temperature Range

-40°F to 180°F (-40°C to 82°C)

Packaging

Polywrapped

Branding (Spiral)

Example: Continental ConitTech Made in Canada

Couplings

Contact fitting manufacturer for proper fitting recommendation and coupling procedure.

Non Stock/Sizes

Custom lengths available. Available with Black Pureten™

Order Codes

Tan Pureten:
549-222 (2"-6⁵/₈")
541-222 (7"-12³/₄")

Plicord® HD Industrial Vacuum

SAP #	ID		Nom. OD		Max. WP		Bend Radius		Vacuum HG		Weight	
	in.	mm	in.	mm	psi	MPa	in.	mm	in.	mm	lb./ft.	kg/m
20140398	2 ³ / ₈	69.9	3.04	77.2	75	0.52	7	178	29	737	1.51	2.25
20015119	3 ¹ / ₂	88.9	4.28	108.7	50	0.34	11	279	29	737	2.63	3.91
20745648	4	101.6	4.76	120.9	50	0.34	12	305	29	737	3.11	4.63
20270756	4 ¹ / ₂	114.3	5.26	133.6	50	0.34	14	356	29	737	3.45	5.13
20251005	5	127.0	5.80	147.3	35	0.24	15	381	29	737	4.29	6.38
20140308	6	152.4	6.80	172.7	35	0.24	18	457	29	737	5.07	7.54
20368104	6 ⁵ / ₈	168.3	7.44	189.0	35	0.24	20	508	29	737	5.78	8.60
20015124	7	177.8	7.81	198.4	35	0.24	21	533	29	737	6.08	9.06
20313490	8	203.2	8.87	225.3	35	0.24	24	610	29	737	7.29	10.86
20540957	8 ⁵ / ₈	219.1	9.48	240.8	35	0.24	26	660	29	737	8.39	12.50
20142810	10	254.0	10.87	276.1	35	0.24	32	813	29	737	9.67	14.41
20320681	12	304.8	12.91	327.9	35	0.24	39	991	29	737	11.81	17.60
20015131	12 ³ / ₄	323.8	13.69	347.7	35	0.24	39	991	29	737	12.69	18.91

Air & Multipurpose
General Purpose
Heavy Duty
Push-on

Chemical Transfer

Cleaning Equipment

Food
Transfer
Washdown

Marine

Material Handling
Abrasives
Bulk Transfer
Cement & Concrete

Mining

Petroleum
Aircraft Fueling
Dispensing
Dock
Transfer

Spray

Steam

Vacuum

LPG Delivery

Water
Discharge
Suction & Discharge
Washdown

Welding

Coupling Systems

Equipment

Appendix

Plicord® Vacuum



Air & Multipurpose
 General Purpose
 Heavy Duty
 Push-on

Chemical Transfer

Cleaning Equipment

Food
 Transfer
 Washdown

Marine

Material Handling
 Abrasives
 Bulk Transfer
 Cement & Concrete

Mining

Petroleum
 Aircraft Fueling
 Dispensing
 Dock
 Transfer

Spray

Steam

Vacuum

LPG Delivery

Water
 Discharge
 Suction & Discharge
 Washdown

Welding

Coupling Systems

Equipment

Appendix

Product Specifications

Application

Heavy-duty construction for handling abrasive particles from metal, rock and marble grinding machines under vacuum. Lightweight construction used to exhaust fumes and abrasive dust from woodworking machines, metal, rock, granite and similar processing equipment

Temperature Range

-25°F to 180°F (-32°C to 82°C)

Branding (Spiral)

Example: Continental ContiTech Plicord® HD Vacuum

Couplings

Contact fitting manufacturer for proper fitting recommendation and coupling procedure.

Construction Tube

Black ChemiTuf® synthetic rubber (static dissipating/static conductive)

Cover

Black SBR synthetic rubber (corrugated)

Reinforcement

Spiral-plied synthetic fabric with wire helix

Plicord® HD Industrial Vacuum

Order Codes: 549-208 (6" and below) 541-208 (8" ID)

SAP #	ID		Nom. OD		Bend Radius		Vacuum HG		Weight	
	in.	mm	in.	mm	in.	mm	psi	MPa	lb./ft.	kg/m
20019382	1½	38.1	1.95	49.5	29	737	6	152	0.77	1.15
20019384	2	50.8	2.46	62.5	29	737	8	203	0.95	1.41
20019385	3	76.2	3.70	94.0	29	737	12	305	2.25	3.35
20019386	4	101.6	4.79	121.7	29	737	16	406	3.34	4.97
20019387	6	152.4	6.80	172.7	29	737	36	914	5.10	7.59
20015105	8	203.2	9.20	233.7	29	737	48	1219	7.53	11.21

Plicord® LW Industrial Vacuum (Lightweight Construction)

Order Codes: 549-207

SAP #	ID		Nom. OD		Bend Radius		Vacuum HG		Weight	
	in.	mm	in.	mm	in.	mm	psi	MPa	lb./ft.	kg/m
20019375	1½	38.1	1.82	46.2	29	737	6	152	0.59	0.88
20019378	2	50.8	2.33	59.2	29	737	8	203	0.70	1.04
20019379	3	76.2	3.33	84.6	29	737	12	305	1.15	1.71
20019380	4	101.6	4.93	125.2	29	737	16	406	1.85	2.75

LPG Delivery



	Page
LPG Delivery Pro	237

Air & Multipurpose

General Purpose
Heavy Duty
Push-on

Chemical Transfer

Cleaning Equipment

Food

Transfer
Washdown

Marine

Material Handling

Abrasives
Bulk Transfer
Cement & Concrete

Mining

Petroleum

Aircraft Fueling
Dispensing
Dock
Transfer

Spray

Steam

Vacuum

LPG Delivery

Water

Discharge
Suction & Discharge
Washdown

Welding

Coupling Systems

Equipment

Appendix

LPG Delivery Pro™



Air & Multipurpose

General Purpose
Heavy Duty
Push-on

Chemical Transfer

Cleaning Equipment

Food
Transfer
Washdown

Marine

Material Handling
Abrasives
Bulk Transfer
Cement & Concrete

Mining

Petroleum
Aircraft Fueling
Dispensing
Dock
Transfer

Spray

Steam

Vacuum

LPG Delivery

Water
Discharge
Suction & Discharge
Washdown

Welding

Coupling Systems

Equipment

Appendix



Product Specifications

Application

LPG Delivery Pro™ is for residential and commercial delivery/transfer of liquid propane gas - the only UL listed LPG bobtail transfer assembly in the market. Excellent cold weather flexibility, a smooth cover for low drag resistance and low tube extraction to reduce contamination.
Not for LP appliances or other consumer applications.

Construction Tube

Nitrile

Cover

Synthetic rubber

Reinforcement

1" and 2" Textile braid, Spiral Reinforced000000

Temperature Range

-40°F to 180°F (-40°C to 82°C)

Packaging

Available in coupled assemblies only

Branding

Example: 1" (25.4mm) LPG Delivery Pro™ CGA Type 1 LPG-Hose Issue No. E-8167 350 psi (2.4 MPa) Max WP. Made in U.S.A.

Couplings

Factory installed crimped fittings only

Order Codes

581-412

LPG Delivery Pro™ 20710255 (1" x 100'), 20458415 (1" x 125'), 20458416 (1" x 150'), 20708132 (1" x 175')

ID	Nom. OD		Max. WP		Weight		
	in.	mm	in.	mm	psi	MPa	lb./ft.
1/2	12.7	0.930	23.6	350	2.41	0.28	0.42
3/4	19.1	1.230	31.2	350	2.41	0.46	0.68
1	25.4	1.490	37.8	350	2.41	0.51	0.76

Water Discharge



	Page	Rubber	Thermoplastic	MSHA	Temp. Range	Coupled Lengths	Lay-flat Construction
Brigade Mine	149		Yes	Yes	-10°F to 150°F (-23°C to 66°C)		Yes
Fire Engine Booster	244	Yes			0°F to 180°F (-18°C to 82°C)	Yes	
Pathfinder Garden Hose	245	Yes			-40°F to 190°F (-40°C to 88°C)	Yes	
Plicord Furnace Door	246	Yes			-25°F to 200°F (-32°C to 93°C)		
Plicord HD Water Discharge	247	Yes			-25°F to 180°F (-32°C to 82°C)		
Potable Water	85	Yes			-25°F to 180°F (-32°C to 82°C)		
Prospector™ Water Discharge 150	248	Yes			-25°F to 180°F (-32°C to 82°C)		
Spiraflex Black Lay-Flat Super Duty	239	Yes			-36°F to 178°F (-38°C to 81°C)		Yes
Spiraflex Blue Extra Light Duty	240		Yes		-10°F to 150°F (-23°C to 66°C)		Yes
Spiraflex Gray Light Duty	241		Yes		-10°F to 150°F (-23°C to 66°C)		Yes
Spiraflex Red Medium Duty	242		Yes	Yes	-10°F to 150°F (-23°C to 66°C)		Yes
Spiraflex Yellow Heavy Duty	243		Yes		-10°F to 150°F (-23°C to 66°C)		Yes

Air & Multipurpose
General Purpose
Heavy Duty
Push-on

Chemical Transfer

Cleaning Equipment

Food
Transfer
Washdown

Marine

Material Handling
Abrasives
Bulk Transfer
Cement & Concrete

Mining

Petroleum
Aircraft Fueling
Dispensing
Dock
Transfer

Spray

Steam

Vacuum

LPG Delivery

Water
Discharge
Suction & Discharge
Washdown

Welding

Coupling Systems

Equipment

Appendix

Spiraflex® Black Lay-Flat Super Duty Hose



Air & Multipurpose

General Purpose

Heavy Duty

Push-on

Chemical Transfer

Cleaning Equipment

Food

Transfer

Washdown

Marine

Material Handling

Abrasives

Bulk Transfer

Cement & Concrete

Mining

Petroleum

Aircraft Fueling

Dispensing

Dock

Transfer

Spray

Steam

Vacuum

LPG Delivery

Water

Discharge

Suction & Discharge

Washdown

Welding

Coupling Systems

Equipment

Appendix

Product Specifications

Application

Spiraflex® Black is a lay-flat, heavy-duty water discharge and washdown hose that combines the lightweight, compact features of PVC with the durability and abrasion resistance of conventional construction. This hose features a unique one-piece, through-the-weave construction and attains its working pressure from a synthetic woven textile. Resists mildew/rot and requires no drying time. Its excellent durability is derived from a high-tensile rubber compound, which completely encases the jacket. Applications include irrigation, washdown, dewatering, coal preparation and utility plants; gas drilling; jetting and pump discharge; storage tank cleaning and sewer cleaning.

Construction Tube and Cover

Nitrile/PVC compound. Both tube and cover are simultaneously extruded to obtain maximum bending.

Reinforcement

Through-the-weave fabric reinforcement

Temperature Range

-36°F to 178°F (-37°C to 81°C)

Packaging

Coiled

Branding

Not branded

Couplings

Contact your Continental ContiTech representative for special production run minimum requirements.

Order Codes

Contact Customer Service for ordering details

Spiraflex® Black Lay-Flat Super Duty Hose

SAP #	ID		Nom. OD		Max. WP		Weight	
	in.	mm	in.	mm	psi	MPa	lb./ft.	kg/m
20466096	1½	38.09	1.58	40.13	300	1.72	0.26	0.38
20466081	2	50.80	2.08	52.83	250	1.72	0.36	0.54
20466020	2½	63.50	2.58	65.53	250	1.72	0.46	0.68
20466098	3	76.19	3.10	78.74	230	1.72	0.52	0.77
20466047	4	101.60	4.10	104.14	200	1.38	0.72	1.07
20466364	6	152.39	6.13	155.70	150	1.03	1.25	1.86
20466752	8	203.20	8.16	207.26	150	1.03	1.70	2.53

Spiraflex® Blue Extra Light Duty



Product Specifications

Application

For light-duty water discharge applications in mining, construction, industry, agricultural and marine service.

Construction Tube

Blue PVC compound

Cover

Blue PVC compound

Reinforcement

Synthetic fabric

Temperature Range

-10°F to 150°F (-23°C to 66°C)

Packaging

300', continuous one piece, coiled and polywrapped

Branding

Example: Continental ContiTech Spiraflex® Blue 2" (50.8 mm) 80 psi WP (.55 MPa)

Couplings

Contact fitting manufacturer for proper fitting recommendation and coupling procedure.

Order Codes

537-564

Spiraflex® Blue Extra Light Duty

SAP #	ID		Nom. OD		Max. WP		Weight	
	in.	mm	in.	mm	psi	MPa	lb./ft.	kg/m
20069152	1½	38.1	1.67	42.4	90	0.62	0.18	0.27
20069153	2	50.8	2.21	56.1	80	0.55	0.24	0.37
20069210	2½	63.5	2.68	68.1	55	0.38	0.35	0.52
20069213	3	76.2	3.20	81.3	55	0.38	0.38	0.56
20069216	4	101.6	4.26	108.2	50	0.34	0.63	0.94
20069219	6	152.4	6.26	159.0	35	0.24	1.14	1.70
20069222	8	203.2	8.32	211.3	35	0.24	1.30	1.93

Note: Working pressures are rated at 72°F (22°C).

Air & Multipurpose

General Purpose
Heavy Duty
Push-on

Chemical Transfer

Cleaning Equipment

Food Transfer Washdown

Marine

Material Handling Abrasives Bulk Transfer Cement & Concrete

Mining

Petroleum Aircraft Fueling Dispensing Dock Transfer

Spray

Steam

Vacuum

LPG Delivery

Water Discharge Suction & Discharge Washdown

Welding

Coupling Systems

Equipment

Appendix

Spiraflex® Gray Light Duty



Product Specifications

Air & Multipurpose

- General Purpose
- Heavy Duty
- Push-on

Chemical Transfer

Cleaning Equipment

- Food**
- Transfer
- Washdown

Marine

- Material Handling**
- Abrasives
- Bulk Transfer
- Cement & Concrete

Mining

- Petroleum**
- Aircraft Fueling
- Dispensing
- Dock
- Transfer

Spray

Steam

Vacuum

LPG Delivery

- Water**
- Discharge
- Suction & Discharge
- Washdown

Welding

Coupling Systems

Equipment

Appendix

Application

For light-duty water discharge service.

Construction Tube

Black Pliovic® compound

Cover

Gray Pliovic compound

Reinforcement

Synthetic fabric

Temperature Range

-10°F to 150°F (-23°C to 66°C)

Packaging

300' continuous one piece, coiled and banded

Branding

Example: Continental ContiTech Spiraflex® Gray 2" (50.8 mm) 80 psi (.55 MPa). Made in U.S.A.

Couplings

Contact fitting manufacturer for proper fitting recommendation and coupling procedure.

Order Codes

537-555

Spiraflex® Gray Light Duty

SAP #	ID		Nom. OD		Max. WP		Weight	
	in.	mm	in.	mm	psi	MPa	lb./ft.	kg/m
20012556	1½	38.1	1.72	43.7	90	0.62	0.18	0.27
20012562	2	50.8	2.22	56.4	80	0.55	0.24	0.35
20012567	2½	63.5	2.79	70.9	60	0.41	0.35	0.52
20012572	3	76.2	3.27	83.1	50	0.34	0.38	0.57
20012576	4	101.6	4.33	110.0	45	0.31	0.63	1.01
20012580	6	152.4	6.38	162.1	35	0.24	1.14	1.70

Note: Working pressures are rated at 72°F (22°C).

Spiraflex® Red Medium Duty



Product Specifications

Application

For medium-duty discharge applications in mining, construction, industry, agriculture and marine service. Limited oil and chemical application.

Construction Tube

Black Pliovic® /Nitrile rubber tube

Cover

Red Pliovic, MSHA 2G-14C/16

Reinforcement

Spiral synthetic yarn, one layer longitudinal synthetic yarn

Temperature Range

-10°F to 150°F (-23°C to 66°C)

Packaging

300' continuous one piece, coiled and banded

Branding

Example: Continental ContiTech Spiraflex® Red 2" (50.8 mm) 150 psi WP (1.03 MPa), Flame Resistant, USMSHA 2G-14C/16. Made in U.S.A.

Couplings

Contact fitting manufacturer for proper fitting recommendation and coupling procedure.

Order Codes

537-521

Spiraflex® Red Medium Duty

SAP #	ID		Nom. OD		Max. WP		Weight	
	in.	mm	in.	mm	psi	MPa	lb./ft.	kg/m
20012500	1½	38.1	1.71	43.4	150	1.03	0.23	0.34
20012501	2	50.8	2.24	56.9	150	1.03	0.36	0.54
20012502	2½	63.5	2.79	70.9	150	1.03	0.41	0.61
20012503	3	76.2	3.29	83.6	125	0.86	0.46	0.68
20012504	4	101.6	4.32	109.7	100	0.69	0.73	1.09
20012505	6	152.4	6.40	162.6	100	0.69	1.18	1.76

Note: Working pressures are rated at 72°F (22°C).

Air & Multipurpose

General Purpose
Heavy Duty
Push-on

Chemical Transfer

Cleaning Equipment

Food Transfer Washdown

Marine

Material Handling

Abrasives
Bulk Transfer
Cement & Concrete

Mining

Petroleum

Aircraft Fueling
Dispensing
Dock
Transfer

Spray

Steam

Vacuum

LPG Delivery

Water Discharge Suction & Discharge Washdown

Welding

Coupling Systems

Equipment

Appendix

Spiraflex® Yellow Heavy Duty Spiraflex® 2700



Product Specifications

Application

For heavy-duty applications in mining, agriculture, construction and marine service. Limited oil and chemical application.

Branding

Example: Continental ContiTech Spiraflex® Yellow 2" (50.8 mm), 200 psi (1.38 MPa) Flame Resistant, USMSHA 2G-14C/15. Made in U.S.A.

Construction Tube

Black Pliovic® /Nitrile PVC Tube

Couplings

Contact fitting manufacturer for proper fitting recommendation and coupling procedure.

Cover

Yellow fire-retardant Pliovic, MSHA 2G-14C/15

Order Codes

537-513

Reinforcement

Synthetic fabric

Temperature Range

-10°F to 150°F (-23°C to 66°C)

Packaging

300' continuous one-piece, coiled and banded

Spiraflex® Yellow Heavy Duty

SAP #	ID		Nom. OD		Max. WP		Weight	
	Yellow	in.	mm	in.	mm	psi	MPa	lb./ft.
20012467	1½	38.1	1.77	45.0	200	1.38	0.32	0.48
20012469	2	50.8	2.34	59.4	200	1.38	0.42	0.63
20012470	2½	63.5	2.88	73.2	200	1.38	0.66	0.98
20012472	3	76.2	3.40	86.4	200	1.38	0.76	1.13
20012475	4	101.6	4.41	112.0	150	1.03	1.00	1.49
20012480	6	152.4	6.48	164.6	150	1.03	1.69	2.51

Note: Working pressures are rated at 72°F.

Air & Multipurpose

General Purpose

Heavy Duty

Push-on

Chemical Transfer

Cleaning Equipment

Food

Transfer

Washdown

Marine

Material Handling

Abrasives

Bulk Transfer

Cement & Concrete

Mining

Petroleum

Aircraft Fueling

Dispensing

Dock

Transfer

Spray

Steam

Vacuum

LPG Delivery

Water

Discharge

Suction & Discharge

Washdown

Welding

Coupling Systems

Equipment

Appendix

Fire Engine Booster



Product Specifications

Application

For use in high-pressure fire engine booster service. Also has many applications in other heavy-duty industrial and municipal operations.

Construction Tube

Synthetic rubber

Cover

Red synthetic rubber

Reinforcement

Braided (2) synthetic yarn

Temperature Range

0°F to 180°F (-18°C to 82°C)

Packaging

Cartons: 1000' (50' increments)
 Cut lengths: 50' (2 pieces); 100' (1 piece)
 Coupled lengths: 50' (2 pieces); 100' (1 piece)

Branding

Example: Continental ContiTech 1" Fire Engine Booster.
 Made in U.S.A.

Couplings

Contact fitting manufacturer for proper fitting recommendation and coupling procedure.

Order Codes

536-382

Fire Engine Booster

SAP #	ID		Nom. OD		Max. WP		Weight	
	in.	mm	in.	mm	psi	MPa	lb./ft.	kg/m
20023056	3/4	19.1	1.25	31.8	800	5.52	0.42	0.62
20023068	1	25.4	1.53	38.9	800	5.52	0.57	0.85

Air & Multipurpose

General Purpose
 Heavy Duty
 Push-on

Chemical Transfer

Cleaning Equipment

Food Washdown

Marine

Material Handling

Abrasives
 Bulk Transfer
 Cement & Concrete

Mining

Petroleum

Aircraft Fueling
 Dispensing
 Dock Transfer

Spray

Steam

Vacuum

LPG Delivery

Water Discharge

Suction & Discharge
 Washdown

Welding

Coupling Systems

Equipment

Appendix

Pathfinder® Garden Hose



Air & Multipurpose

- General Purpose
- Heavy Duty
- Push-on

Chemical Transfer

Cleaning Equipment

- Food**
- Transfer
- Washdown

Marine

Material Handling

- Abrasives
- Bulk Transfer
- Cement & Concrete

Mining

Petroleum

- Aircraft Fueling
- Dispensing
- Dock
- Transfer

Spray

Steam

Vacuum

LPG Delivery

Water

- Discharge
- Suction & Discharge
- Washdown

Welding

Coupling Systems

Equipment

Appendix

Product Specifications

Application

For in-home, lawn and garden, apartment, smaller plant and commercial property applications.

Construction Tube

EPDM synthetic rubber

Cover

Green EPDM synthetic rubber

Reinforcement

Spiral synthetic yarn

Temperature Range

-40°F to 190°F (-40°C to 88°C)

Packaging

500' reels, maximum 3 pieces, 50' increments

Branding

Example: 5/8" (15.9mm) Pathfinder® Continental ContiTech 100 psi WP

Couplings

Contact fitting manufacturer for proper fitting recommendation and coupling procedure.

Non-Stock/Sizes

Available in 25' or 50' coupled assemblies.

Order Codes

569-027

Pathfinder® Garden Hose

SAP #	ID		Nom. OD		Max. WP		Weight	
	in.	mm	in.	mm	psi	MPa	lb./ft.	kg/m
20026213	5/8	15.9	0.94	23.9	100	0.69	0.22	0.33

Plicord® Furnace Door



Product Specifications

Application

For carrying cooling water to furnace doors in steel mills and similar service operations where the outside of the hose is subjected to open flame and elevated temperatures.

Construction Tube

SBR synthetic rubber (non-conductive)

Cover

Fiberglass fabric ply over rubber cover

Reinforcement

Spiral-plied (4) plies of synthetic fabric

Temperature Range

-25°F to 200°F (-32°C to 93°C)

Packaging

1/2"-4" - 100' lengths, coiled and polywrapped

Branding

Not branded

Couplings

Contact fitting manufacturer for proper fitting recommendation and coupling procedure.

Order Codes

542-309

Plicord® Furnace Door

SAP #	ID		Nom. OD		Max. WP		Weight		
	Fiberglass	in.	mm	in.	mm	psi	MPa	lb./ft.	kg/m
20016515		1/2	12.7	1.06	26.9	200	1.38	0.38	0.57
20016518		3/4	19.1	1.32	33.5	200	1.38	0.52	0.77
20016522		1	25.4	1.64	41.7	200	1.38	0.76	1.13
20018362		1¼	31.8	2.06	52.3	200	1.38	1.19	1.77
20016527		1½	38.1	2.30	58.4	200	1.38	1.36	2.02
20016530		2	50.8	2.87	72.9	200	1.38	1.85	2.75
20069910		2½	63.5	3.36	85.3	200	1.38	2.23	3.32
20187448		4	102.0	4.87	123.8	150	1.03	6.90	10.30

Air & Multipurpose
 General Purpose
 Heavy Duty
 Push-on

Chemical Transfer

Cleaning Equipment

Food
 Transfer
 Washdown

Marine

Material Handling
 Abrasives
 Bulk Transfer
 Cement & Concrete

Mining

Petroleum
 Aircraft Fueling
 Dispensing
 Dock
 Transfer

Spray

Steam

Vacuum

LPG Delivery

Water
 Discharge
 Suction & Discharge
 Washdown

Welding

Coupling Systems

Equipment

Appendix

Plicord® HD Water Discharge



Air & Multipurpose

General Purpose
Heavy Duty
Push-on

Chemical Transfer

Cleaning Equipment

Food
Transfer
Washdown

Marine

Material Handling
Abrasives
Bulk Transfer
Cement & Concrete

Mining

Petroleum
Aircraft Fueling
Dispensing
Dock
Transfer

Spray

Steam

Vacuum

LPG Delivery

Water
Discharge
Suction & Discharge
Washdown

Welding

Coupling Systems

Equipment

Appendix

Product Specifications

Application

A heavy-duty, all-purpose hose with excellent abrasion resistance. It is ideal for service in quarries, mines and construction.

Construction Tube

Black SBR synthetic rubber

Cover

Black SBR synthetic rubber (wrapped finish)

Reinforcement

Spiral-plied (4) plies of synthetic fabric

Temperature Range

-25°F to 180°F (-32°C to 82°C)

Packaging

1'-8" - 100' lengths, coiled and polywrapped

Branding (Spiral)

Example: Continental ContiTech Plicord® HD Water

Couplings

Contact fitting manufacturer for proper fitting recommendation and coupling procedure.

Order Codes

542-437 (65/8" and below)

541-437 (8" and above)

Plicord® HD Water Discharge

SAP #	ID		Nom. OD		Max. WP		Weight	
	in.	mm	in.	mm	psi	MPa	lb./ft.	kg/m
20016585	1½	38.1	2.00	50.8	200	1.38	0.79	1.18
20016592	2	50.8	2.50	63.5	200	1.38	0.97	1.44
20016598	2½	63.5	3.06	77.7	200	1.38	1.36	2.02
20016602	3	76.2	3.55	90.2	200	1.38	1.60	2.38
20016608	4	101.6	4.58	116.3	150	1.03	2.10	3.13
20016613	4½	114.3	5.07	128.8	150	1.03	2.34	3.48
20016614	5	127.0	5.57	141.5	150	1.03	2.59	3.85
20016618	6	152.4	6.53	165.9	150	1.03	2.87	4.27
20015553	6⅝	168.3	7.22	183.4	150	1.03	3.58	5.33
20015559	8	203.2	8.57	217.7	100	0.69	4.06	6.04
20620155	8⅝	219.1	9.19	233.4	100	0.69	4.57	6.81
20015561	10	254.0	10.63	270.0	100	0.69	5.73	8.54
20015564	12	304.8	12.66	321.6	100	0.69	6.79	10.12

Prospector™ Water Discharge 150



Product Specifications

Application

For use in heavy-duty service for a wide range of applications.

Construction Tube

Black SBR synthetic rubber

Cover

Black SBR synthetic rubber

Reinforcement

Spiral-plied synthetic fabric

Temperature Range

-25°F to 180°F (-32°C to 82°C)

Packaging

3/4"-6" - 100' lengths, coiled and polywrapped

Branding (Spiral)

Example: Prospector™ Water Discharge 150

Couplings

Contact fitting manufacturer for proper fitting recommendation and coupling procedure.

Order Codes

542-439 (1/2"-6")

Prospector™ Water Discharge 150

SAP #	ID		Nom. OD		Max. WP		Weight	
	in.	mm	in.	mm	psi	MPa	lb./ft.	kg/m
20016664	3/4	19.1	1.04	26.4	150	1.03	0.23	0.34
20016665	1	25.4	1.29	32.8	150	1.03	0.30	0.45
20016666	1¼	31.8	1.60	40.6	150	1.03	0.43	0.64
20016669	1½	38.1	1.84	46.7	150	1.03	0.50	0.74
20016673	2	50.8	2.38	60.5	150	1.03	0.71	1.06
20016676	2½	63.5	2.87	72.9	150	1.03	0.87	1.29
20016678	3	76.2	3.47	88.1	150	1.03	1.37	2.04
20016683	4	101.6	4.50	114.3	150	1.03	1.80	2.68
20016689	6	152.4	6.49	164.9	150	1.03	2.53	3.76

Air & Multipurpose

General Purpose
Heavy Duty
Push-on

Chemical Transfer

Cleaning Equipment

Food

Transfer
Washdown

Marine

Material Handling

Abrasives
Bulk Transfer
Cement & Concrete

Mining

Petroleum

Aircraft Fueling
Dispensing
Dock
Transfer

Spray

Steam

Vacuum

LPG Delivery

Water

Discharge
Suction & Discharge
Washdown

Welding

Coupling Systems

Equipment

Appendix

Water Suction & Discharge



Air & Multipurpose

- General Purpose
- Heavy Duty
- Push-on

Chemical Transfer

Cleaning Equipment

Food

- Transfer
- Washdown

Marine

Material Handling

- Abrasives
- Bulk Transfer
- Cement & Concrete

Mining

Petroleum

- Aircraft Fueling
- Dispensing
- Dock Transfer

Spray

Steam

Vacuum

LPG Delivery

**Water
Discharge
Suction & Discharge
Washdown**

Welding

Coupling Systems

Equipment

Appendix

	Page	Rubber	Thermoplastic	Clear	Temp. Range	Tube Compound
Cold Blue	252		Yes	Yes	-40°F to 150°F (-40°C to 66°C)	PVC
Flexwing Water S&D	256	Yes			-25°F to 180°F (-23°C to 82°C)	SBR
Green Hornet XF	253		Yes		-40°F to 180°F (-40°C to 82°C)	TPR/PVC
Plicord Versiflo 125	251	Yes			-25°F to 200°F (-32°C to 82°C)	EPDM
Prospector Water S&D	258	Yes			-25°F to 200°F (-32°C to 93°C)	SBR
Spiraflex 1600	254		Yes		0°F to 158°F (-18°C to 70°C)	PVC
Spiraflex Aggie PVC	255		Yes	Yes	0°F to 158°F (-18°C to 70°C)	PVC
Velocity WT	250		Yes	Yes	-13°F to 140°F (-25°C to 60°C)	
Versiflo 150 Water S&D	257	Yes			-25°F to 200°F (-23°C to 93°C)	EPDM

Velocity™ WT



Product Specifications

The Velocity Water Transfer Hose gets water where you need it, efficiently and fast. This tough clear PVC hose lets you see water in motion, even in the most demanding applications. Whether you need full suction or transfer, the Velocity WT is the hose for your jobsite.

Application

For water transfer. PVC Premium Heavy-Duty Clear Water Suction Hose. Premium heavy-duty construction for great durability. Clear PVC allows for visual confirmation of product flow.

Construction Tube

Flexible PVC, rigid PVC helix, synthetic braiding, smooth bore, corrugate OD.

Temperature Range

-13°F to 140°F (-25°C to 60°C)

Couplings

Contact fitting manufacturer for proper fitting recommendation and coupling procedure.

Order Codes

591-101

Velocity™ WT

Part #	ID		Nom. OD		Max. WP @ 72°F (22°C)		Bend Radius	Vacuum HG @ 72°F (22°C)		Length
	in.	mm	in.	mm	psi	MPa		in.	mm	
20762594	1½	38.1	2.03	51.7	110	0.76	2½	29	737	100
20762595	2	50.8	2.46	62.5	100	0.69	4	29	737	100
20635650	3	76.2	3.71	94.5	100	0.69	6	29	737	100
20635651	4	101.6	4.75	120.6	75	0.52	7	29	737	100
20761726	4	101.6	4.75	120.6	75	0.52	7	29	737	60
20630166	6	152.4	7.15	181.6	70	0.48	10	29	737	100
20762596	6	152.4	7.15	181.6	70	0.48	10	29	737	60
20761732	8	203.2	9.2	233.8	60	0.41	15	29	737	20

Air & Multipurpose

General Purpose
Heavy Duty
Push-on

Chemical Transfer

Cleaning Equipment

Food
Transfer
Washdown

Marine

Material Handling
Abrasives
Bulk Transfer
Cement & Concrete

Mining

Petroleum
Aircraft Fueling
Dispensing
Dock
Transfer

Spray

Steam

Vacuum

LPG Delivery

Water
Discharge
Suction & Discharge
Washdown

Welding

Coupling Systems

Equipment

Appendix

Plicord® Versiflo® 125



Air & Multipurpose

- General Purpose
- Heavy Duty
- Push-on

Chemical Transfer

Cleaning Equipment

Food

- Transfer
- Washdown

Marine

Material Handling

- Abrasives
- Bulk Transfer
- Cement & Concrete

Mining

Petroleum

- Aircraft Fueling
- Dispensing
- Dock Transfer

Spray

Steam

Vacuum

LPG Delivery

Water Discharge Suction & Discharge Washdown

Welding

Coupling Systems

Equipment

Appendix

Product Specifications

Application

For medium-duty water discharge service where the hose does not encounter severe handling.

Construction Tube

Black EPDM synthetic rubber

Cover

Black EPDM (wrapped finish)

Reinforcement

Spiral-plied synthetic fabric

Temperature Range

-25°F to 200°F (-32°C to 82°C)

Packaging

100' lengths, coiled and polywrapped

Branding (Spiral)

Example: Continental ConiTech Versiflo® 125 Water Discharge

Couplings

Contact fitting manufacturer for proper fitting recommendation and coupling procedure.

Non-Stock/Sizes

For special production run minimum requirements, see Appendix D.

Order Code

542-527

Plicord® Versiflo® 125

SAP #	Description	ID		Nom. OD		Max. WP		Weight	
		in.	mm	in.	mm	psi	MPa	lb./ft.	kg/m
20016803	VERSIFLO DIS 1-1/4X100 FT 125PSI	1¼	31.8	1.48	37.6	125	0.86	0.26	0.39
20016806	VERSIFLO DIS 1-1/2X100 FT 125PSI	1½	38.1	1.72	43.7	125	0.86	0.30	0.45
20016808	VERSIFLO DIS 2X100 FT 125PSI	2	50.8	2.24	56.9	125	0.86	0.40	0.60
20016811	VERSIFLO 2-1/2X100 FT 125PSI	2½	63.5	2.73	69.3	125	0.86	0.49	0.73
20016813	VERSIFLO DIS 3X100 FT 125PSI	3	76.2	3.22	81.8	125	0.86	0.58	0.86
20016815	VERSIFLO DIS 4X100 FT 125PSI	4	101.6	4.21	106.9	125	0.86	0.83	1.24
20016817	VERSIFLO DIS 6X100 FT 125PSI	6	152.4	6.32	160.5	125	0.86	1.58	2.35

Cold Blue™



Product Specifications

Application

A lightweight, medium-duty water suction and discharge hose for industrial, construction, agricultural, mining and other applications where low temperature flexibility is required.

Construction Tube

Clear flexible PVC

Reinforcement

Blue rigid PVC helix

Temperature Range

-40°F to 150°F (-40°C to 65°C)

Branding

Not branded

Packaging

100' coils, covered with corrugated cardboard and wrapped with clear stretch film.

Order Codes

586-518

Cold Blue™

SAP #	ID	Nom. OD		Max. WP		Bend Radius		Vacuum HG		Weight		
		in.	mm	in.	mm	in.	mm	in.	mm	lb./ft.	kg/m	
20446623	3/4	19.1	.99	25.1	120	.83	3	76	29	737	.163	.242
20442995	1	25.4	1.25	31.8	106	.73	5	127	29	737	.229	.341
20439810	1¼	31.8	1.54	39.2	99	.68	5	127	29	737	.305	.454
20439811	1½	38.1	1.77	44.9	89	.61	6	152	29	737	.372	.559
20187679	2	50.8	2.33	59.2	80	.55	8	203	29	737	.583	.869
20439812	2½	63.5	2.87	72.9	65	.45	10	254	29	737	.840	1.25
20187760	3	76.2	3.40	86.5	65	.45	12	305	29	737	1.01	1.50
20187761	4	101.6	4.50	114.0	55	.38	16	406	29	737	1.65	2.46
20444339	6	152.4	6.62	168.2	47	.32	36	914	29	737	3.27	4.87

Testing performed at 70°F.

Air & Multipurpose
General Purpose
Heavy Duty
Push-on

Chemical Transfer

Cleaning Equipment

Food
Transfer
Washdown

Marine

Material Handling
Abrasives
Bulk Transfer
Cement & Concrete

Mining

Petroleum
Aircraft Fueling
Dispensing
Dock
Transfer

Spray

Steam

Vacuum

LPG Delivery

Water
Discharge
Suction & Discharge
Washdown

Welding

Coupling Systems

Equipment

Appendix

Green Hornet® XF

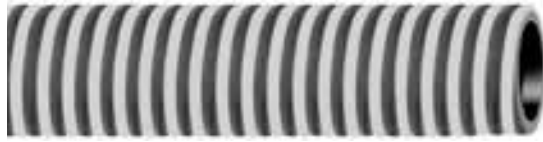

Air & Multipurpose
 General Purpose
 Heavy Duty
 Push-on

Chemical Transfer

Cleaning Equipment

Food
 Transfer
 Washdown

Marine

Material Handling
 Abrasives
 Bulk Transfer
 Cement & Concrete

Mining

Petroleum
 Aircraft Fueling
 Dispensing
 Dock
 Transfer

Spray

Steam

Vacuum

LPG Delivery

Water
 Discharge
 Suction & Discharge
 Washdown

Welding

Coupling Systems

Equipment

Appendix

Product Specifications

Application

Medium-duty, light-weight construction; retains flexibility in cold weather. Smooth-bore tube minimizes material buildup and resists a variety of chemicals found in agricultural and sanitary industries. Slightly corrugated outer helix promotes abrasion resistance, low coefficient of friction and ease of coupling. Common uses can be found in waste management, construction, agricultural, marine and manufacturing industries.

Construction Tube

Black thermoplastic rubber, RMA Class B (medium oil resistance)

Reinforcement

Rigid, lime-green polyethylene helix; available in a variety of custom colors

Temperature Range

-40°F to 180°F (-40°C to 82°C)

Packaging

100' lengths, coiled and polywrapped

Branding (Spiral)

Not branded

Couplings

Contact fitting manufacturer for proper fitting recommendation and coupling procedure

Order Codes

586-551

Green Hornet® XF

SAP #	ID		Nom. OD		Max. WP		Bend Radius		Vacuum HG		Weight	
	in.	mm	in.	mm	psi	MPa	in.	mm	in.	mm	lb./ft.	kg/m
20450178	1¼	31.8	1.53	39.0	50	0.35	2.5	63.5	29	737	0.27	0.40
20450177	1½	38.1	1.78	45.3	50	0.35	3	76.2	29	737	0.32	0.48
20450179	2	50.8	2.40	61.0	50	0.35	4	101.6	29	737	0.56	0.83
20450350	2½	63.5	2.99	74.9	50	0.35	5	127.0	29	737	0.75	1.12
20450351	3	76.2	3.47	88.1	45	0.31	5	127.0	29	737	0.92	1.37
20450352	4	101.6	4.67	118.4	40	0.28	9	228.6	29	737	1.60	2.39
20450353	6	152.4	6.75	171.4	25	0.17	20	508.0	29	737	2.88	4.30

SpiraFlex® 1600



Product Specifications

Application

For water suction and discharge service in construction and septic tank cleaning operations, and for general industrial and agricultural applications where mild chemical resistance is required.

Construction Tube

Olive green Pliovic® with high-density rigid helix

Reinforcement

Olive green Pliovic® with high-density rigid helix

Temperature Range

0°F to 158°F (-9°C to 70°C)

Packaging

3/4"-6" - 100' lengths, coiled and polywrapped
8"-10" - 20' lengths, coiled and polywrapped

Branding

Not branded

Couplings

Contact fitting manufacturer for proper fitting recommendation and coupling procedure.

Order Codes

586-411

SpiraFlex® 1600

SAP #	ID		Nom. OD		Max. WP		Bend Radius		Vacuum HG		Weight	
	in.	mm	in.	mm	psi	MPa	in.	mm	in.	mm	lb./ft.	kg/m
20013191	3/4	19.1	0.98	24.9	130	0.90	3	83	29	737	0.18	0.27
20013194	1	25.4	1.24	31.5	106	0.73	5	114	29	737	0.25	0.37
20013197	1¼	31.8	1.53	38.9	99	0.68	5	127	29	737	0.32	0.48
20013203	1½	38.1	1.78	45.2	89	0.61	6	152	29	737	0.37	0.55
20013209	2	50.8	2.32	58.9	79	0.54	8	203	29	737	0.61	0.91
20013213	2½	63.5	2.85	72.4	65	0.45	10	254	29	737	0.87	1.29
20013219	3	76.2	3.41	86.6	65	0.45	12	305	29	737	1.08	1.61
20013223	4	101.6	4.46	113.3	55	0.38	16	406	29	737	1.69	2.51
20013231	6	152.4	6.57	166.9	47	0.32	36	914	29	737	3.05	4.54
20013236	8	203.2	8.92	226.6	40	0.28	60	1524	20	508	6.35	9.45
20013239	10	254.0	10.93	277.6	35	0.24	100	2540	20	508	8.75	13.04

Air & Multipurpose

General Purpose
Heavy Duty
Push-on

Chemical Transfer

Cleaning Equipment

Food Transfer Washdown

Marine

Material Handling

Abrasives
Bulk Transfer
Cement & Concrete

Mining

Petroleum

Aircraft Fueling
Dispensing
Dock
Transfer

Spray

Steam

Vacuum

LPG Delivery

Water Discharge Suction & Discharge Washdown

Welding

Coupling Systems

Equipment

Appendix

SpiraFlex® Aggie PVC



Product Specifications

Air & Multipurpose

- General Purpose
- Heavy Duty
- Push-on

Chemical Transfer

Cleaning Equipment

- Food**
- Transfer
- Washdown

Marine

Material Handling

- Abrasives
- Bulk Transfer
- Cement & Concrete

Mining

Petroleum

- Aircraft Fueling
- Dispensing
- Dock Transfer

Spray

Steam

Vacuum

LPG Delivery

- Water**
- Discharge
- Suction & Discharge
- Washdown

Welding

Coupling Systems

Equipment

Appendix

Application

A general-purpose water suction hose for use in industrial, agriculture and construction applications.

Construction Tube

Clear Pliovic®

Reinforcement

High-density white rigid Pliovic helix

Temperature Range

0°F to 158°F (-9°C to 70°C)

Packaging

100' lengths coiled and polywrapped

Branding (Spiral)

Not branded

Couplings

Contact fitting manufacturer for proper fitting recommendation and coupling procedure.

Order Codes

586-453

SpiraFlex®

SAP #	ID	Nom. OD		Max. WP		Bend Radius		Vacuum HG		Weight		
		in.	mm	in.	mm	in.	mm	in.	mm	lb./ft.	kg/m	
20013491	3/4	19.1	1.00	25.4	120	0.83	3.0	76	29	737	0.18	0.27
20013493	1	25.4	1.24	31.5	106	0.73	4.5	114	29	737	0.23	0.34
20013495	1¼	31.8	1.53	38.9	99	0.68	5.0	127	29	737	0.34	0.51
20013497	1½	38.1	1.78	45.2	89	0.61	6.0	152	29	737	0.38	0.57
20013500	2	50.8	2.31	58.7	79	0.54	8.0	203	29	737	0.58	0.86
20013504	2½	63.5	2.85	72.4	65	0.45	10.0	254	29	737	0.90	1.34
20013507	3	76.2	3.41	86.6	65	0.45	12.0	305	29	737	1.07	1.59
20013510	4	101.6	4.47	113.5	55	0.38	16.0	406	29	737	1.69	2.51
20013516	6	152.4	6.60	167.6	47	0.32	36.0	914	29	737	3.29	4.90

Flexwing® Water S&D



Product Specifications

Application

A general-purpose, economical hose for applications in light or medium water suction and discharge operations. Rated for full vacuum. Used in various industrial, agricultural and construction areas.

Construction Tube

Black SBR Synthetic Rubber

Cover

Black SBR Synthetic Rubber

Reinforcement

Synthetic fabric plies with internal wire helix

Temperature Range

-25°F to 180°F (-32°C to 82°C)

Packaging

3/4"-6" - 100' lengths, coiled and polywrapped
8"-12" - Custom length

Branding

Example: Flexwing® Water S&D

Couplings

Contact fitting manufacturer for proper fitting recommendation and coupling procedure.

Order Codes

542-249 (3/4"-6")
541-249 (8"-12")

Flexwing® Water S&D

SAP #	ID	Nom. OD		Max. WP		Bend Radius		Vacuum HG		Weight		
		in.	mm	in.	mm	psi	MPa	in.	mm	in.	mm	lb./ft.
20026570	3/4	19.0	1.09	27.9	150	0.86	2	50	29	737	0.33	0.49
20026608	1	25.3	1.34	34.1	150	0.86	2	50	29	737	0.41	0.61
20026605	1¼	32.0	1.61	40.8	150	0.86	4	100	29	737	0.50	0.75
20026606	1½	38.0	1.84	46.9	150	0.86	4	100	29	737	0.63	0.94
20462936	2	51.1	2.38	60.4	150	0.86	7	180	29	737	0.84	1.25
20462937	2½	63.6	2.89	73.3	150	0.86	10	250	29	737	1.08	1.61
20462938	3	76.1	3.42	86.8	150	0.86	14	360	29	737	1.46	2.18
20462939	3½	90.0	3.97	100.9	150	0.86	14	360	29	737	1.80	2.68
20462940	4	102.1	4.45	113.1	150	0.86	18	460	29	737	2.03	3.02
20462941	5	127.3	5.53	140.5	150	0.86	20	510	29	737	3.34	4.98
20462942	6	152.6	6.63	168.0	150	0.86	24	610	29	737	4.67	6.96
20026598	8	203.5	8.75	222.3	125	0.86	48	1200	29	737	7.56	11.26
20531203	10	253.9	10.97	278.3	125	0.86	60	1500	29	737	12.34	18.39
20464167	12	305.5	12.19	335.4	125	0.86	72	1800	29	737	19.07	28.41

Air & Multipurpose
General Purpose
Heavy Duty
Push-on

Chemical Transfer

Cleaning Equipment

Food
Transfer
Washdown

Marine

Material Handling
Abrasives
Bulk Transfer
Cement & Concrete

Mining

Petroleum
Aircraft Fueling
Dispensing
Dock
Transfer

Spray

Steam

Vacuum

LPG Delivery

Water
Discharge
Suction & Discharge
Washdown

Welding

Coupling Systems

Equipment

Appendix

Versiflo® 150 Water S&D



Product Specifications

Application

General-purpose water suction and discharge for medium- to heavy-duty applications. Can be used in Lasso® applications.

Branding (Spiral)

Example: Continental ContiTech Versiflo® 150 Water Suction & Discharge

Construction Tube

Black EPDM synthetic rubber (wrapped finish)

Couplings

Contact fitting manufacturer for proper fitting recommendation and coupling procedure.

Reinforcement

Spiral plied synthetic fabric with wire helix

Temperature Range

-25°F to 200°F (-32°C to 93°C)

Order Codes

542-528 (1 1/4"-6")

541-528 (8"-14")

Packaging

542-528 - 100' lengths, coiled and polywrapped

541-528 - custom lengths

Verisiflo® 150 Water S&D

SAP #	ID	Nom. OD		Max. WP		Bend Radius		Vacuum HG		Weight			
		in.	mm	in.	mm	psi	MPa	in.	mm	in.	mm	lb./ft.	kg/m
Black													
20016820	1/4	31.8	1.63	41.4	150	1.03	4	102	29	737	0.53	0.79	
20016822	1 1/2	38.1	1.87	47.5	150	1.03	4	102	29	737	0.65	0.97	
20016828	2	50.8	2.39	60.7	150	1.03	7	178	29	737	0.87	1.29	
20016831	2 1/2	63.5	2.89	73.4	150	1.03	10	254	29	737	1.08	1.61	
20016834	3	76.2	3.42	86.9	150	1.03	14	356	29	737	1.44	2.14	
20016838	4	101.6	4.45	113.0	150	1.03	18	457	29	737	2.00	2.98	
20016841	6	152.4	6.60	167.6	150	1.03	24	610	29	737	4.56	6.79	
20115258	8	203.0	8.75	238.0	150	1.03	48	1200	29	737	7.40	11.00	
20669573	10	254.0	10.96	278.0	150	1.03	60	1500	29	737	12.20	18.20	
20669574	12	305.0	13.23	336.0	150	1.03	72	1800	29	737	18.70	27.90	

Air & Multipurpose

General Purpose

Heavy Duty

Push-on

Chemical Transfer

Cleaning Equipment

Food

Transfer

Washdown

Marine

Material Handling

Abrasives

Bulk Transfer

Cement & Concrete

Mining

Petroleum

Aircraft Fueling

Dispensing

Dock

Transfer

Spray

Steam

Vacuum

LPG Delivery

Water

Discharge

Suction & Discharge

Washdown

Welding

Coupling Systems

Equipment

Appendix

Prospector™ Water S&D



Product Specifications

Application

Available 1" to 6" ID

Water suction and discharge hose for medium- to heavy-duty applications, used in the discharge of fluids from frac tanks

Construction Tube

Synthetic rubber tube with black synthetic rubber wrapped cover with embossed layline

Temperature Range

-25°F to 200°F (-32°C to 93°C)

Couplings

Using ContiTech brand of Insta-Lock™ cam & groove fittings

Order Codes

542-032

Prospector™ Water S&D

Part #	ID		Nom. OD		Max. WP		Bend Radius		Vacuum HG		Weight	
	in.	mm	in.	mm	psi	MPa	in.	mm	in.	mm	lb./ft.	kg/m
20704261	1	25.4	1.348	34.2	150	1.03	2	51	29	737	0.42	0.625
20704263	1½	38.1	1.852	47.0	150	1.03	4	102	29	737	0.64	0.948
20704264	2	50.8	2.352	59.7	150	1.03	7	178	29	737	0.83	1.232
20704265	2½	63.5	2.893	73.5	150	1.03	10	255	29	737	1.09	1.624
20704266	3	76.2	3.436	87.3	150	1.03	14	356	29	737	1.19	1.771
20704267	4	101.6	4.447	112.9	150	1.03	18	457	29	737	2.05	3.052
20704268	6	152.4	6.613	168.0	150	1.03	24	612	29	737	4.91	7.307

Air & Multipurpose

General Purpose
Heavy Duty
Push-on

Chemical Transfer

Cleaning Equipment

Food
Transfer
Washdown

Marine

Material Handling
Abrasives
Bulk Transfer
Cement & Concrete

Mining

Petroleum
Aircraft Fueling
Dispensing
Dock
Transfer

Spray

Steam

Vacuum

LPG Delivery

Water
Discharge
Suction & Discharge
Washdown

Welding

Coupling Systems

Equipment

Appendix

Notes

Air & Multipurpose

- General Purpose
- Heavy Duty
- Push-on

Chemical Transfer

Cleaning Equipment

Food

- Transfer
- Washdown

Marine

Material Handling

- Abrasives
- Bulk Transfer
- Cement & Concrete

Mining

Petroleum

- Aircraft Fueling
- Dispensing
- Dock
- Transfer

Spray

Steam

Vacuum

LPG Delivery

Water

- Discharge
- Suction & Discharge
- Washdown

Welding

Coupling Systems

Equipment

Appendix

Water Washdown



	Page	Temp. Range	Non-Marking Cover	Superior Oil Resistance Cover	Superior Abrasion Cover	Microban Cover	Tapered Nozzle	Textile	Wire
Fortress 300	93	-20°F to 200°F (-29°C to 93°C)	Yes	Yes	Yes	Yes		Yes	
Fortress 1000	94	-20°F to 200°F (-29°C to 93°C)	Yes	Yes	Yes	Yes		Yes	
Fortress 3000	95	-20°F to 250°F (-29°C to 121°C)	Yes	Yes	Yes	Yes			Yes
Gauntlet 1500	62	-20°F to 200°F (-29°C to 93°C)	Yes*	Yes	Yes			Yes	
Plicord Washdown	262	-25°F to 200°F (-29°C to 93°C)					Yes	Yes	
Pulp & Paper Washdown	263	-25°F to 200°F (-29°C to 93°C)					Yes	Yes	
Sani-Wash 300	98	-40°F to 205°F (-40°C to 96°C)	Yes					Yes	
Sani-Wash Plus 300	97	-20°F to 200°F (-29°C to 93°C)	Yes	Yes				Yes	
Super Sani-Wash 300	99	-40°F to 200°F (-40°C to 93°C)	Yes			Yes		Yes	
Sureline	261	-40°F to 190°F (-40°C to 88°C)	Yes*					Yes	

*Nonblack Colors

Air & Multipurpose

General Purpose
Heavy Duty
Push-on

Chemical Transfer

Cleaning Equipment

Food

Transfer
Washdown

Marine

Material Handling

Abrasives
Bulk Transfer
Cement & Concrete

Mining

Petroleum

Aircraft Fueling
Dispensing
Dock
Transfer

Spray

Steam

Vacuum

LPG Delivery

Water

Discharge
Suction & Discharge
Washdown

Welding

Coupling Systems

Equipment

Appendix

Sureline®



Air & Multipurpose

General Purpose
Heavy Duty
Push-on

Chemical Transfer

Cleaning Equipment

Food
Transfer
Washdown

Marine

Material Handling
Abrasives
Bulk Transfer
Cement & Concrete

Mining

Petroleum
Aircraft Fueling
Dispensing
Dock
Transfer

Spray

Steam

Vacuum

LPG Delivery

Water
Discharge
Suction & Discharge
Washdown

Welding

Coupling Systems

Equipment

Appendix

Product Specifications

Application

For a wide range of industrial, construction, and agricultural water discharge applications in which a general-service water hose is needed.

Construction Tube

EPDM synthetic rubber, RMA Class C (limited oil resistance)

Cover

Red or black EPDM synthetic rubber

Reinforcement

Spiral synthetic yarn

Temperature Range

-40°F to 190°F (-40°C to 88°C)

Packaging

3/16"-3/4" - 500' reels, maximum 3 pieces, 50' increments
1" - 450' reels, maximum 3 pieces, 50' increments
1 1/4" - 400' reels, maximum 3 pieces, 50' increments
1 1/2" - 300' reels, maximum 3 pieces, 50' increments

Branding (Spiral)

Example: 1/2" Sureline® Continental ContiTech 150 psi WP

Couplings

Contact fitting manufacturer for proper fitting recommendation and coupling procedure.

Order Codes

569-048 (red)
569-049 (black)

Sureline®

SAP #		ID		Nom. OD		Max. WP		Weight	
Red	Black	in.	mm	in.	mm	psi	MPa	lb./ft.	kg/m
20026443	20026458	1/4	6.4	0.48	12.2	150	1.03	0.08	0.12
20026444	20026459	3/8	9.5	0.66	16.8	150	1.03	0.13	0.19
20026447	20026465	1/2	12.7	0.78	19.8	150	1.03	0.17	0.25
20026448	20026474	5/8	15.9	0.93	23.6	150	1.03	0.26	0.39
20026451	20026485	3/4	19.1	1.08	27.4	150	1.03	0.33	0.49
20026454	20026501	1	25.4	1.39	35.3	150	1.03	0.52	0.77
20026455	20026508	1 1/4	31.8	1.63	41.4	150	1.03	0.57	0.85
20026456	20026512	1 1/2	38.1	1.88	47.8	150	1.03	0.68	1.01

Plicord® Washdown with Optional Integral Tapered Nozzle



Product Specifications

Application

Plicord® Washdown hose is a quality water discharge hose for the environments typically found in paper mills and other industrial operations. Can be supplied with an integral rubber nozzle.

Construction Tube

Black SBR synthetic rubber

Cover

Black SBR synthetic rubber (wrapped impression). Also available in green or white cover (non-FDA).

Reinforcement

Spiral-plied synthetic fabric

Temperature Range

-25°F to 200°F (-32°C to 93°C)

Packaging

50' lengths, coiled and polywrapped

Branding (Spiral)

Example: Continental ContiTech Plicord® Washdown, 150 Max WP

Couplings

Contact fitting manufacturer for proper fitting recommendation and coupling procedure. Also available with integral tapered nozzle.

Non-Stock/Sizes

Hose: 400' minimum order/400' increments
Hose with tapered nozzle: Two 50' lengths, two length increments

Order Codes

542-454 (black)
542-455 (green)
542-507 (white)

Plicord® Washdown

SAP #			ID		Nom. OD		Max. WP		Weight	
Black	Green	White	in.	mm	in.	mm	psi	MPa	lb./ft.	kg/m
20016718	20016737	20016775	3/4	19.1	1.17	29.7	150	1.03	0.36	0.54
20016722	20016742	20016781	1	25.4	1.42	36.1	150	1.03	0.45	0.67
20016727	20016745	20016784	1¼	31.8	1.69	42.9	150	1.03	0.55	0.82
20016729	20139579	20649827	1½	38.1	1.97	50.0	150	1.03	0.71	1.06

Orifice sizes: 3/4" ID-1/2" Orifice
1" ID-1/2" Orifice
1¼" ID-5/8" Orifice
1½" ID-3/4" Orifice

Air & Multipurpose

General Purpose
Heavy Duty
Push-on

Chemical Transfer

Cleaning Equipment

Food Transfer Washdown

Marine

Material Handling Abrasives Bulk Transfer Cement & Concrete

Mining

Petroleum Aircraft Fueling Dispensing Dock Transfer

Spray

Steam

Vacuum

LPG Delivery

Water Discharge Suction & Discharge Washdown

Welding

Coupling Systems

Equipment

Appendix

Pulp & Paper Washdown with Optional Integral Tapered Nozzle



Air & Multipurpose
General Purpose
Heavy Duty
Push-on

Chemical Transfer

Cleaning Equipment

Food
Transfer
Washdown

Marine

Material Handling
Abrasives
Bulk Transfer
Cement & Concrete

Mining

Petroleum
Aircraft Fueling
Dispensing
Dock
Transfer

Spray

Steam

Vacuum

LPG Delivery

Water
Discharge
Suction & Discharge
Washdown

Welding

Coupling Systems

Equipment

Appendix

Product Specifications

Application

Heavy-duty water discharge hose for washdown service in pulp and paper mills where kink resistance is of major importance.

Construction Tube

Black EPDM synthetic rubber (also available in white, non-FDA)

Cover

Black EPDM synthetic rubber

Reinforcement

Spiral-plyed synthetic fabric

Temperature Range

-25°F to 200°F (-32°C to 93°C)

Packaging

50' lengths, coiled and polywrapped

Branding (Spiral)

Example: Continental ContiTecg HD Washdown, 300 psi Max WP

Couplings

Contact fitting manufacturer for proper fitting recommendation and coupling procedure. Also available with integral tapered nozzle.

Non-Stock/Sizes

Hose: 400' minimum order/400' increments
Hose with tapered nozzle: Two 50' lengths, two 50' length increments

Order Codes

542-452

Plicord® Pulp & Paper Washdown

SAP #	ID		Nom. OD		Max. WP		Weight	
	in.	mm	in.	mm	psi	MPa	lb./ft.	kg/m
20024998	3/4	19.1	1.30	33.0	300	2.07	0.47	0.70
20029385	1	25.4	1.62	41.2	300	2.07	0.67	1.00
20016713	1¼	31.8	1.88	47.8	300	2.07	0.81	1.21
20100952	1½	38.1	2.11	53.7	300	2.07	0.91	1.36

Orifice sizes: 3/4" ID-1/2" Orifice
1" ID-1/2" Orifice
1¼" ID-5/8" Orifice
1½" ID-3/4" Orifice

Welding



Air & Multipurpose

General Purpose
Heavy Duty
Push-on

Chemical Transfer

Cleaning Equipment

Food

Transfer
Washdown

Marine

Material Handling

Abrasives
Bulk Transfer
Cement & Concrete

Mining

Petroleum

Aircraft Fueling
Dispensing
Dock
Transfer

Spray

Steam

Vacuum

LPG Delivery

Water

Discharge
Suction & Discharge
Washdown

Welding

Coupling Systems

Equipment

Appendix

	Page	Oxygen (Green)	Acetylene (Red)	Fuel Gases* (Red)	Flame and Oil Resistant Tube	Flame and Oil Resistant Cover
Single Line Welding Grade R	270	Yes	Yes	No	No	No
Single Line Welding Grade RM	271	Yes	Yes	No	No	Yes
Single Line Welding Grade T	269	Yes	Yes	Yes	Yes	Yes
Twin-Line Welding Grade R	266	Yes	Yes	No	No	No
Twin-Line Welding Grade RM	267	Yes	Yes	No	No	Yes
Twin-Line Welding Grade T	268	Yes	Yes	Yes	Yes	Yes

*Fuel Gases are defined in ARPM IP-7-2011 welding hose standard. Flammable compressed gases commonly used in the welding and cutting industry including, but not limited to, acetylene, hydrogen, methane/natural gas, LP gas, propylene and methylacetylene propadiene stabilized.

ARPM IP-7-2011 and CGA E-1

Twin-Line Welding Grade R - Type VD



Product Specifications

Application

For welding service. Meets ARPM IP-7-2011 standard for Grade R welding hose.

Construction Tube

EPDM synthetic rubber compatible with oxygen and acetylene gases

Cover

EPDM synthetic rubber smooth surface

Reinforcement

Spiral synthetic yarn

Temperature Range

-40°F to 120°F (-40°C to 49°C)

Packaging

500' reels

Branding

Example: Twin-Line 1/4" Grade R Acetylene Only Std Duty Max. WP 200 psi Meets ARPM IP-7-2011. Made In U.S.A. Continental ContiTech

Couplings

Contact fitting manufacturer for proper fitting recommendation and coupling procedure..

Order Codes

569-588

Twin-Line Welding Grade R

SAP #	ID		Nom. OD		Max. WP		Weight	
	in.	mm	in.	mm	psi	MPa	lb./ft.	kg/m
20027120	3/16	4.8	0.44	11.2	200	1.38	0.13	0.19
20027170	1/4	6.4	0.53	13.5	200	1.38	0.18	0.27
20027203	5/16	7.9	0.59	15.0	200	1.38	0.22	0.33
20027224	3/8	9.5	0.66	16.8	200	1.38	0.26	0.39

Note: For Welding Hose Precautions, see Appendix C.

Air & Multipurpose

General Purpose
Heavy Duty
Push-on

Chemical Transfer

Cleaning Equipment

Food Transfer Washdown

Marine

Material Handling

Abrasives
Bulk Transfer
Cement & Concrete

Mining

Petroleum

Aircraft Fueling
Dispensing
Dock
Transfer

Spray

Steam

Vacuum

LPG Delivery

Water

Discharge
Suction & Discharge
Washdown

Welding

Coupling Systems

Equipment

Appendix

Twin-Line Welding Grade RM - Type VD

Air & Multipurpose

General Purpose
Heavy Duty
Push-on

Chemical Transfer

Cleaning Equipment

Food
Transfer
Washdown

Marine

Material Handling
Abrasives
Bulk Transfer
Cement & Concrete

Mining

Petroleum
Aircraft Fueling
Dispensing
Dock
Transfer

Spray

Steam

Vacuum

LPG Delivery

Water
Discharge
Suction & Discharge
Washdown

Welding

Coupling Systems

Equipment

Appendix



Product Specifications

Application

For welding service. Meets ARPM IP-7-2011 standard for Grade RM welding hose. Non-conductive.

Construction Tube

SBR synthetic rubber compatible with oxygen and acetylene gases

Cover

Chemivic™ synthetic rubber smooth cover

Reinforcement

Spiral synthetic yarn

Temperature Range

-40°F to 120°F (-40°C to 49°C)

Packaging

500' reels

Branding

Example: Twin-Line 1/4" Grade RM Acetylene Only Std Duty Max. WP 200 psi Meets ARPM IP-7-2011. Made In U.S.A. Continental ContiTech

Couplings

Contact fitting manufacturer for proper fitting recommendation and coupling procedure.

Order Codes

569-598

Twin-Line Welding Grade RM

SAP #	ID		Nom. OD		Max. WP		Weight	
	in.	mm	in.	mm	psi	MPa	lb./ft.	kg/m
20027317	3/16	4.8	0.44	11.2	200	1.38	0.15	0.22
20027342	1/4	6.4	0.53	13.5	200	1.38	0.21	0.31
20027356	5/16	7.9	0.59	15.0	200	1.38	0.25	0.37
20189609	3/8	9.5	0.66	16.8	200	1.38	0.29	0.43

Note: For Welding Hose Precautions, see Appendix C.

Twin-Line Welding Grade T - Type VD



Product Specifications

Application

For welding service. Meets ARPM IP-7-2011 and CGA E-1 standards for Grade T welding hose. Non-conductive.

Construction Tube

Wingprene® synthetic rubber compatible with all common welding fuel gases

Cover

Chemivic™ synthetic rubber smooth cover

Reinforcement

Spiral synthetic yarn

Temperature Range

-40°F to 120°F (-40°C to 49°C)

Packaging

500' reels

Branding

Example: Twin-Line 1/4" Grade T Fuel Gas Std Duty Max. WP 200 psi Meets ARPM IP-7-2011/CGA E-1. Made In U.S.A. Continental ContiTech

Couplings

Contact fitting manufacturer for proper fitting recommendation and coupling procedure..

Order Codes

569-618

Twin-Line Welding Grade T

SAP #	ID		Nom. OD		Max. WP		Weight	
	in.	mm	in.	mm	psi	MPa	lb./ft.	kg/m
20027443	3/16	4.8	0.44	11.2	200	1.38	0.13	0.19
20027465	1/4	6.4	0.53	13.5	200	1.38	0.18	0.27
20027480	5/16	7.9	0.59	15.0	200	1.38	0.22	0.33
20027498	3/8	9.5	0.66	16.8	200	1.38	0.26	0.39

Note: For Welding Hose Precautions, see Appendix C.

Air & Multipurpose

General Purpose
Heavy Duty
Push-on

Chemical Transfer

Cleaning Equipment

Food Transfer Washdown

Marine

Material Handling Abrasives Bulk Transfer Cement & Concrete

Mining

Petroleum Aircraft Fueling Dispensing Dock Transfer

Spray

Steam

Vacuum

LPG Delivery

Water Discharge Suction & Discharge Washdown

Welding

Coupling Systems

Equipment

Appendix

Single Line Welding Grade T



Air & Multipurpose

General Purpose
Heavy Duty
Push-on

Chemical Transfer

Cleaning Equipment

Food
Transfer
Washdown

Marine

Material Handling
Abrasives
Bulk Transfer
Cement & Concrete

Mining

Petroleum
Aircraft Fueling
Dispensing
Dock
Transfer

Spray

Steam

Vacuum

LPG Delivery

Water
Discharge
Suction & Discharge
Washdown

Welding

Coupling Systems

Equipment

Appendix



Product Specifications

Application

For welding service. Meets ARPM IP-7-2011 and CGA E-1 standards for Grade T welding hose. Non-conductive.

Construction Tube

Wingprene® synthetic rubber compound compatible with all common welding fuel gases

Cover

Chemivic™ synthetic rubber ribbed surface

Reinforcement

Spiral synthetic yarn

Temperature Range

-40°F to 120°F (-40°C to 49°C)

Packaging

500' reels

Branding

Example: 1/4" Grade T Fuel Gas Std Duty Max. WP 200 psi Meets ARPM IP-7-2011CGA E-1. Made In U.S.A. Continental ContiTech

Couplings

Contact fitting manufacturer for proper fitting recommendation and coupling procedure.

Order Codes

569-619 (red cover) (acetylene or other common welding fuel gas)
569-620 (green cover) (oxygen)

Single Line Welding Grade T

		ID		Nom. OD		Max. WP		Weight	
		in.	mm	in.	mm	psi	MPa	lb./ft.	kg/m
Red (Acetylene)	Green (Oxygen)	3/16	4.8	0.44	11.1	200	1.38	0.08	0.12
20685102	Call for information	1/4	6.4	0.53	13.5	200	1.38	0.10	0.15
20027506	20683454	5/16	7.9	0.60	15.1	200	1.38	0.12	0.18
20309892	20308955	3/8	9.5	0.66	16.7	200	1.38	0.14	0.21
20027510	20027514								

Note: For Welding Hose Precautions, see Appendix C.

Single Line Welding Grade R



Product Specifications

Application

For welding service. Meets ARPM IP-7-2011 standard for Grade R welding hose.

Construction Tube

EPDM synthetic rubber

Cover

EPDM synthetic rubber ribbed surface

Reinforcement

Spiral synthetic yarn

Temperature Range

-40°F to 120°F (-40°C to 49°C)

Packaging

500' reels

Branding

Example: 1/4" Grade R Acetylene Only Std Duty Max. WP 200 psi Meets ARPM IP-7-2011. Made In U.S.A. Continental ContiTech

Couplings

Contact fitting manufacturer for proper fitting recommendation and coupling procedure.

Order Codes

569-591 (red cover) (acetylene)

569-592 (green cover) (oxygen)

Single Line Welding Grade R

SAP #		ID		Nom. OD		Max. WP		Weight	
Red (Acetylene)	Green (Oxygen)	in.	mm	in.	mm	psi	MPa	lb./ft.	kg/m
20027257	20027276	3/16	4.8	0.44	11.1	200	1.38	0.08	0.12
20027261	20027280	1/4	6.4	0.53	13.5	200	1.38	0.10	0.15
20027267	20027292	5/16	7.9	0.60	15.1	200	1.38	0.11	0.16
20027271	20027295	3/8	9.5	0.66	16.7	200	1.38	0.13	0.19

Note: For Welding Hose Precautions, see Appendix C.

Air & Multipurpose

General Purpose
Heavy Duty
Push-on

Chemical Transfer

Cleaning Equipment

Food Transfer Washdown

Marine

Material Handling Abrasives Bulk Transfer Cement & Concrete

Mining

Petroleum Aircraft Fueling Dispensing Dock Transfer

Spray

Steam

Vacuum

LPG Delivery

Water Discharge Suction & Discharge Washdown

Welding

Coupling Systems

Equipment

Appendix

Single Line Welding Grade RM



Air & Multipurpose

General Purpose
Heavy Duty
Push-on

Chemical Transfer

Cleaning Equipment

Food
Transfer
Washdown

Marine

Material Handling
Abrasives
Bulk Transfer
Cement & Concrete

Mining

Petroleum
Aircraft Fueling
Dispensing
Dock
Transfer

Spray

Steam

Vacuum

LPG Delivery

Water
Discharge
Suction & Discharge
Washdown

Welding

Coupling Systems

Equipment

Appendix

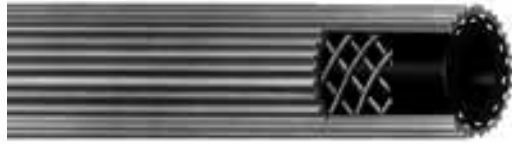

Product Specifications

Application

For welding service. Meets ARPM IP-7-2011 standard for Grade RM welding hose.

Construction Tube

SBR synthetic rubber (non-conductive)

Cover

Chemivic™ synthetic rubber ribbed surface

Reinforcement

Spiral synthetic yarn

Temperature Range

-40°F to 120°F (-40°C to 49°C)

Packaging

500' reels

Branding

Example: 1/4" Grade RM Oxygen Std Duty Max. WP 200 psi Meets ARPM IP-7-2011. Made In U.S.A. Continental ContiTech

Couplings

Contact fitting manufacturer for proper fitting recommendation and coupling procedure..

Order Codes

569-589 (red cover) (acetylene)
569-590 (green cover) (oxygen)

Single Line Welding Grade RM

	ID		Nom. OD		Max. WP		Weight			
	Red (Acetylene)	Green (Oxygen)	in.	mm	in.	mm	psi	MPa	lb./ft.	kg/m
	20027237	20027249	1/4	6.4	0.53	13.5	200	1.38	0.10	0.15

Note: For Welding Hose Precautions, see Appendix C.

Coupling Systems



Air & Multipurpose

General Purpose
Heavy Duty
Push-on

Chemical Transfer

Cleaning Equipment

Food

Transfer
Washdown

Marine

Material Handling

Abrasives
Bulk Transfer
Cement & Concrete

Mining

Petroleum

Aircraft Fueling
Dispensing
Dock
Transfer

Spray

Steam

Vacuum

LPG Delivery

Water

Discharge
Suction & Discharge
Washdown

Welding

Coupling Systems

Equipment

Appendix

	Page	Aluminum	Stainless Steel	Brass	Carbon Steel	Steel
Insta-Lock Dust Cap	282	Yes	Yes	Yes	No	No
Insta-Lock Dust Plug	283	Yes	Yes	Yes	No	Yes
Insta-Lock Fittings Reducers & Jump Sizes	280	Yes	Yes		Yes	Yes
Insta-Lock Gaskets	285				No	No
Insta-Lock Interlocking Ferrules	286		Yes		Yes	
Insta-Lock Interlocking Stainless Steel Male NPT Hose Stem	281		Yes			
Insta-Lock Repair Kits	284		Yes	Yes		
Insta-Lock Type A	274	Yes	Yes	Yes		
Insta-Lock Type B	275	Yes	Yes	Yes		
Insta-Lock Type C	276	Yes	Yes	Yes		
Insta-Lock Type D	277	Yes	Yes	Yes		
Insta-Lock Type E	278	Yes	Yes	Yes		
Insta-Lock Type F	279	Yes	Yes	Yes	No	Yes
Pressure Washer Fittings	288					Yes
Stainless Steel & Aluminum Crimp Sleeves for Infinity™ and Paladin® Hose	287	Yes	Yes			

Insta-Lock™ Type A Male Adapter X Female NPT Thread

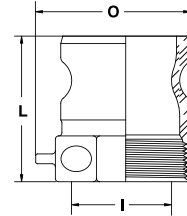

Product Specifications

Application

Type A fitting is commonly threaded onto a pipe, threaded hose end or manifold system, which is connected and disconnected on a regular basis. Insta-Lock™ fittings are designed for liquids and dry bulk. Consult the chemical resistance guide for specific chemical recommendations.

Materials

Aluminum, 316# Stainless Steel and Brass

Pressure Rating

Sizes 1/2"-2", 250 psi; sizes 2½"-4", 150 psi; sizes 5"-6", 75 psi. Recommended working pressure ratings based on ambient temperature 70°F (21°C).

Branding

Example: Continental ContiTech A200SS

Order Codes

650-825 (aluminum), 650-833 (brass),
650-841 (stainless steel)

Insta-Lock™ Type A Male Adapter X Female NPT Thread

Size	Aluminum	Stainless Steel	Brass
1/2	A050AL	A050SS	A050BR
3/4	A075AL	A075SS	A075BR
1	A100AL	A100SS	A100BR
1¼	A125AL	A125SS	A125BR
1½	A150AL	A150SS	A150BR
2	A200AL	A200SS	A200BR
2½	A250AL	A250SS	A250BR
3	A300AL	A300SS	A300BR
4	A400AL	A400SS	A400BR
5	A500AL	A500SS	A500BR
6	A600AL	A600SS	A600BR

Size	Distance Chain Lug Extends from Body	Overall Length (L)	Maximum Width Across Adapter (O)	Minimum ID (I)
in.	in.	in.	in.	in.
1/2	0.375	1.656	1.500	0.500
3/4	0.375	1.656	1.688	0.781
1	0.375	2.163	1.804	0.875
1¼	0.375	2.437	2.237	1.063
1½	0.375	2.531	2.368	1.375
2	0.375	2.781	2.909	1.750
2½	0.375	3.093	3.585	2.187
3	0.375	3.281	4.009	2.812
4	0.375	3.528	5.257	3.750
5	0.375	3.813	6.438	4.688
6	0.375	3.656	7.688	5.750

Note: Continental ContiTech Insta-Lock™ fittings are never to be used in steam or compressed air service.

Air & Multipurpose
General Purpose
Heavy Duty
Push-on

Chemical Transfer

Cleaning Equipment

Food
Transfer
Washdown

Marine

Material Handling
Abrasives
Bulk Transfer
Cement & Concrete

Mining

Petroleum
Aircraft Fueling
Dispensing
Dock
Transfer

Spray

Steam

Vacuum

LPG Delivery

Water
Discharge
Suction & Discharge
Washdown

Welding

Coupling Systems

Equipment

Appendix

Insta-Lock™ Type B Female Coupler X Male NPT Thread



Product Specifications

Application

Type B fitting is normally threaded onto a pipe or manifold which joins to a rubber hose assembly that is connected and disconnected regularly. Insta-Lock™ fittings are designed for liquids and dry bulk. Consult the chemical resistance guide for specific chemical recommendations.

Materials

Aluminum, 316# Stainless Steel and Brass

Pressure Rating

Sizes 1/2"-2", 250 psi; sizes 2½"-4", 150 psi; sizes 5"-6", 75 psi. Recommended working pressure ratings based on ambient temperature 70°F (21°C) with Standard Nitrile gaskets.

Branding

Example: Continental ContiTech B200SS

Order Codes

650-826 (aluminum), 650-834 (brass),
650-842 (stainless steel)

Insta-Lock™ Type B Female Coupler X Male NPT Thread

Size	Aluminum	Stainless Steel	Brass
1/2	B050AL	B050SS	B050BR
3/4	B075AL	B075SS	B075BR
1	B100AL	B100SS	B100BR
1¼	B125AL	B125SS	B125BR
1½	B150AL	B150SS	B150BR
2	B200AL	B200SS	B200BR
2½	B250AL	B250SS	B250BR
3	B300AL	B300SS	B300BR
4	B400AL	B400SS	B400BR
5	B500AL	B500SS	B500BR
6	B600AL	B600SS	B600BR

Size	Max. Width with Cam Arms Closed (O)	Overall Length (L)	Exposed Length (E)	Minimum ID (I)	Max. Width with Cam Arms Extended (C)
in.	in.	in.	in.	in.	in.
1/2	2.469	1.906	1.188	0.469	4.969
3/4	2.781	2.031	1.313	0.688	5.261
1	2.920	2.500	1.625	0.875	5.367
1¼	3.510	2.937	2.000	1.063	7.669
1½	3.830	2.937	2.000	1.375	7.967
2	4.210	3.218	2.156	1.750	8.340
2½	4.720	3.718	2.250	2.187	8.837
3	5.680	4.000	2.468	2.812	10.435
4	6.780	4.218	2.593	3.750	11.538
5	7.813	4.406	2.625	4.688	12.571
6	9.344	4.750	2.844	5.750	16.096

Note: Continental ContiTech Insta-Lock™ fittings are never to be used in steam or compressed air service. Continental ContiTech Products Insta-Lock™ Cam Arms are designed exclusively for Insta-Lock™ fittings.

Air & Multipurpose

General Purpose

Heavy Duty

Push-on

Chemical Transfer

Cleaning Equipment

Food

Transfer

Washdown

Marine

Material Handling

Abrasives

Bulk Transfer

Cement & Concrete

Mining

Petroleum

Aircraft Fueling

Dispensing

Dock

Transfer

Spray

Steam

Vacuum

LPG Delivery

Water

Discharge

Suction & Discharge

Washdown

Welding

Coupling Systems

Equipment

Appendix

Insta-Lock™ Type C Female Coupler X Hose Shank

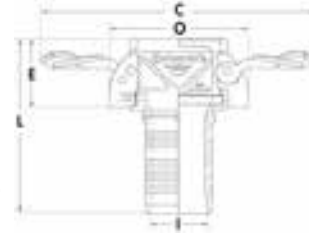

Product Specifications

Application

Type C fitting can be attached to a rubber hose with the use of interlocking ferrules, crimp sleeves, or bands. Insta-Lock™ fittings are designed for liquids and dry bulk. Consult the chemical resistance guide for specific chemical recommendations.

Materials

Aluminum, 316# Stainless Steel and Brass

Pressure Rating

Sizes 1/2"-2", 250 psi; sizes 2½"-4", 150 psi; sizes 5"-6", 75 psi. Recommended working pressure ratings based on ambient temperature 70°F (21°C) with Standard Nitrile gaskets.

Branding

Example: Continental ContiTech C200SS

Order Codes

650-827 (aluminum), 650-835 (brass),
650-843 (stainless steel)

Insta-Lock™ Type C Female Coupler X Hose Shank

Size	Aluminum	Stainless Steel	Brass
1/2	C050AL	C050SS	C050BR
3/4	C075AL	C075SS	C075BR
1	C100AL	C100SS	C100BR
1¼	C125AL	C125SS	C125BR
1½	C150AL	C150SS	C150BR
2	C200AL	C200SS	C200BR
2½	C250AL	C250SS	C250BR
3	C300AL	C300SS	C300BR
4	C400AL	C400SS	C400BR
5	C500AL	C500SS	C500BR
6	C600AL	C600SS	C600BR

Size	Max. Width with Cam Arms Closed (O)	Overall Length (L)	Exposed Length (E)	Minimum ID (I)	Max. Width with Cam Arms Extended (C)
in.	in.	in.	in.	in.	in.
1/2	2.469	3.063	1.188	0.260	4.969
3/4	2.781	3.656	1.313	0.490	5.261
1	2.920	4.250	1.975	0.718	5.367
1¼	3.510	4.625	2.350	0.906	7.669
1½	3.830	4.750	2.370	1.156	7.967
2	4.210	5.281	2.531	1.625	8.340
2½	4.720	5.750	2.625	2.093	8.837
3	5.680	6.840	2.849	2.560	10.435
4	6.780	7.218	2.994	3.468	11.538
5	7.813	7.563	2.625	4.469	12.571
6	9.344	8.969	2.844	5.469	16.096

Note: Continental ContiTech Insta-Lock™ fittings are never to be used in steam or compressed air service. Continental ContiTech Products Insta-Lock™ Cam Arms are designed exclusively for Insta-Lock™ fittings.

Air & Multipurpose
General Purpose
Heavy Duty
Push-on

Chemical Transfer

Cleaning Equipment

Food
Transfer
Washdown

Marine

Material Handling
Abrasives
Bulk Transfer
Cement & Concrete

Mining

Petroleum
Aircraft Fueling
Dispensing
Dock
Transfer

Spray

Steam

Vacuum

LPG Delivery

Water
Discharge
Suction & Discharge
Washdown

Welding

Coupling Systems

Equipment

Appendix

Insta-Lock™ Type D Female Coupler X Female NPT Thread

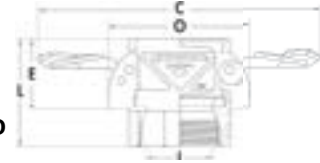

Product Specifications

Application

Type D fitting is commonly threaded onto a pipe, threaded hose end or manifold system, which is connected and disconnected on a regular basis. Insta-Lock™ fittings are designed for liquids and dry bulk. Consult the chemical resistance guide for specific chemical recommendations.

Materials

Aluminum, 316# Stainless Steel and Brass

Pressure Rating

Sizes 1/2"-2", 250 psi; sizes 2½"-4", 150 psi; sizes 5"-6", 75 psi. Recommended working pressure ratings based on ambient temperature 70°F (21°C) with Standard Nitrile gaskets.

Branding

Example: Continental ContiTech D200SS

Order Codes

650-828 (aluminum), 650-836 (brass),
650-844 (stainless steel)

Insta-Lock™ Type D Female Coupler X Female NPT Thread

Size	Aluminum	Stainless Steel	Brass
1/2	D050AL	D050SS	D050BR
3/4	D075AL	D075SS	D075BR
1	D100AL	D100SS	D100BR
1¼	D125AL	D125SS	D125BR
1½	D150AL	D150SS	D150BR
2	D200AL	D200SS	D200BR
2½	D250AL	D250SS	D250BR
3	D300AL	D300SS	D300BR
4	D400AL	D400SS	D400BR
5	D500AL	D500SS	D500BR
6	D600AL	D600SS	D600BR

Size	Max Width with CAM Arms Closed (O)	Overall Length (L)	Exposed Length (E)	Minimum ID (I)	Max Width with CAM Arms Extended (C)
in.	in.	in.	in.	in.	in.
1/2	2.469	1.813	1.188	0.656	4.969
3/4	2.781	2.063	1.313	0.813	5.261
1	2.920	2.375	1.975	1.000	5.367
1¼	3.510	2.687	2.350	1.300	7.669
1½	3.830	2.843	2.370	1.560	7.967
2	4.210	3.156	2.531	1.937	8.340
2½	4.720	3.437	2.625	2.312	8.837
3	5.680	3.718	2.849	2.937	10.435
4	6.780	4.030	2.994	3.750	11.538
5	7.813	4.313	2.563	4.688	12.571
6	9.344	4.513	2.719	5.750	16.096

Note: Continental ContiTech Insta-Lock™ fittings are never to be used in steam or compressed air service. Continental ContiTech Products Insta-Lock™ Cam Arms are designed exclusively for Insta-Lock™ fittings.

Air & Multipurpose
General Purpose
Heavy Duty
Push-on

Chemical Transfer

Cleaning Equipment

Food
Transfer
Washdown

Marine

Material Handling
Abrasives
Bulk Transfer
Cement & Concrete

Mining

Petroleum
Aircraft Fueling
Dispensing
Dock
Transfer

Spray

Steam

Vacuum

LPG Delivery

Water
Discharge
Suction & Discharge
Washdown

Welding

Coupling Systems

Equipment

Appendix

Insta-Lock™ Type E Male Adapter X Hose Shank

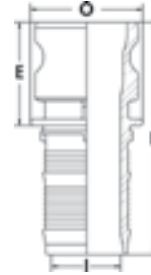

Product Specifications

Application

Type E fitting can be attached to a rubber hose with the use of interlocking ferrules, crimp sleeve and bands. Insta-Lock™ fittings are designed for liquids and dry bulk. Consult the chemical resistance guide for specific chemical recommendations.

Materials

Aluminum, 316# Stainless Steel and Brass

Pressure Rating

Sizes 1/2"-2", 250 psi; sizes 2½"-4", 150 psi; sizes 5"-6", 75 psi. Recommended working pressure ratings based on ambient temperature 70°F (21°C) with Standard Nitrile gaskets.

Branding

Example: Continental ContiTech E200SS

Order Codes

650-829 (aluminum), 650-837 (brass),
650-845 (stainless steel)

Insta-Lock™ Type E Male Adapter X Hose Shank

Size	Aluminum	Stainless Steel	Brass
1/2	E050AL	E050SS	E050BR
3/4	E075AL	E075SS	E075BR
1	E100AL	E100SS	E100BR
1¼	E125AL	E125SS	E125BR
1½	E150AL	E150SS	E150BR
2	E200AL	E200SS	E200BR
2½	E250AL	E250SS	E250BR
3	E300AL	E300SS	E300BR
4	E400AL	E400SS	E400BR
5	E500AL	E500SS	E500BR
6	E600AL	E600SS	E600BR

Size	Maximum OD (O)	Overall Length (L)	Exposed Length (E)	Minimum ID (I)
in.	in.	in.	in.	in.
1/2	1.188	3.500	1.625	0.260
3/4	1.262	3.969	1.625	0.490
1	1.625	4.569	1.944	0.718
1¼	2.000	4.812	2.187	0.906
1½	2.312	5.000	2.250	1.156
2	2.687	5.625	2.500	1.625
2½	3.062	6.187	2.687	2.093
3	3.781	7.125	2.750	2.562
4	4.875	7.434	2.809	3.468
5	6.563	7.844	2.906	4.469
6	7.125	9.188	3.063	5.469

Note: Continental ContiTech Insta-Lock™ fittings are never to be used in steam or compressed air service.

Air & Multipurpose
General Purpose
Heavy Duty
Push-on

Chemical Transfer

Cleaning Equipment

Food
Transfer
Washdown

Marine

Material Handling
Abrasives
Bulk Transfer
Cement & Concrete

Mining

Petroleum
Aircraft Fueling
Dispensing
Dock
Transfer

Spray

Steam

Vacuum

LPG Delivery

Water
Discharge
Suction & Discharge
Washdown

Welding

Coupling Systems

Equipment

Appendix

Insta-Lock™ Type F Male Adapter X Male NPT Thread

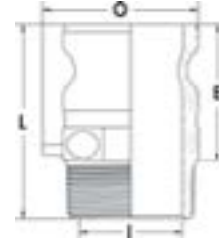

Product Specifications

Application

Type F fitting is normally threaded onto a pipe, or manifold connections and mated with Part C, Part B or Part D.

Used in applications that require frequent connections. Insta-Lock™ fittings are designed for liquids and dry bulk. Consult the chemical resistance guide for specific chemical recommendations.

Materials

Aluminum, 316# Stainless Steel and Brass

Pressure Rating

Sizes 1/2"-2", 250 psi; sizes 2½"-4", 150 psi; sizes 5"-6", 75 psi. Recommended working pressure ratings based on ambient temperature 70°F (21°C).

Branding

Example: Continental ContiTech F200SS

Order Codes

650-830 (aluminum), 650-838 (brass),
650-846 (stainless steel)

Insta-Lock™ Type F Male Adapter X Male NPT Thread

Size	Aluminum	Stainless Steel	Brass
1/2	F050AL	F050SS	F050BR
3/4	F075AL	F075SS	F075BR
1	F100AL	F100SS	F100BR
1¼	F125AL	F125SS	F125BR
1½	F150AL	F150SS	F150BR
2	F200AL	F200SS	F200BR
2½	F250AL	F250SS	F250BR
3	F300AL	F300SS	F300BR
4	F400AL	F400SS	F400BR
5	F500AL	F500SS	F500BR
6	F600AL	F600SS	F600BR

Size	Max. Width Across Adapter (O)	Overall Length (L)	Exposed Length (E)	Minimum ID (I)	Distance Chain Lug Extends from BOD (C)
in.	in.	in.	in.	in.	in.
1/2	1.150	2.250	1.531	0.469	0.375
3/4	1.688	2.375	1.656	0.688	0.375
1	1.730	2.819	2.038	0.875	0.375
1¼	2.130	3.156	2.279	1.187	0.375
1½	2.300	3.222	2.347	1.437	0.375
2	2.909	3.593	2.596	1.750	0.375
2½	3.281	4.218	2.812	2.187	0.375
3	3.844	4.343	2.875	2.812	0.375
4	4.994	4.746	3.184	3.734	0.375
5	6.188	4.906	3.125	4.688	0.375
6	7.500	5.219	3.313	5.750	0.375

Note: Continental ContiTech Insta-Lock™ fittings are never to be used in steam or compressed air service. Continental ContiTech Products Insta-Lock™ Cam Arms are designed exclusively for Insta-Lock™ fittings.

Air & Multipurpose
General Purpose
Heavy Duty
Push-on

Chemical Transfer

Cleaning Equipment

Food
Transfer
Washdown

Marine

Material Handling
Abrasives
Bulk Transfer
Cement & Concrete

Mining

Petroleum
Aircraft Fueling
Dispensing
Dock
Transfer

Spray

Steam

Vacuum

LPG Delivery

Water
Discharge
Suction & Discharge
Washdown

Welding

Coupling Systems

Equipment

Appendix

Insta-Lock™ Fittings – Reducers & Jump Sizes



Insta-Lock™ Fittings – Reducers & Jump Sizes

Continental ContiTech SAP	Part Name	Description	Size	Material
in.	in.	in.	in.	in.
20668616	AA200AL	Spool Adapter (Male X Male)	2 X 2	Aluminum
20668617	AA300AL	Spool Adapter (Male X Male)	3 X 3	Aluminum
20668618	AA400AL	Spool Adapter (Male X Male)	4 X 4	Aluminum
20668774	DA3020AL	Jump Size Female Coupler X Male Adapter	3 X 2	Aluminum
20668775	DA3040AL	Jump Size Female Coupler X Male Adapter	3 X 4	Aluminum
20668776	DA4030AL	Jump Size Female Coupler X Male Adapter	4 X 3	Aluminum
20668777	DA6040AL	Jump Size Female Coupler X Male Adapter	6 X 4	Aluminum
20668779	DD300AL	Female Coupler X Female Coupler	3 X 3	Aluminum
20668780	DD400AL	Female Coupler X Female Coupler	4 X 4	Aluminum
20739387	C3024SS	Female Coupler X Barb Stainless	3 X 2½	Stainless Steel
20739389	E3025SS	Male Adapter X Barb	3 X 2½	Stainless Steel

Air & Multipurpose
General Purpose
Heavy Duty
Push-on

Chemical Transfer

Cleaning Equipment

Food
Transfer
Washdown

Marine

Material Handling
Abrasives
Bulk Transfer
Cement & Concrete

Mining

Petroleum
Aircraft Fueling
Dispensing
Dock
Transfer

Spray

Steam

Vacuum

LPG Delivery

Water
Discharge
Suction & Discharge
Washdown

Welding

Coupling Systems

Equipment

Appendix

Insta-Lock™ Interlocking Stainless Steel Male NPT Hose Stem

Air & Multipurpose

General Purpose

Heavy Duty

Push-on

Chemical Transfer

Cleaning Equipment

Food

Transfer

Washdown

Marine

Material Handling

Abrasives

Bulk Transfer

Cement & Concrete

Mining

Petroleum

Aircraft Fueling

Dispensing

Dock

Transfer

Spray

Steam

Vacuum

LPG Delivery

Water

Discharge

Suction & Discharge

Washdown

Welding

Coupling Systems

Equipment

Appendix



Product Specifications

Application

Interlocking Stainless Steel Male NPT Hose Stem fittings are designed to be attached to a rubber hose with the use of a Continental ContiTech Insta-Lock™ Ferrule. Consult the chemical resistance guide for specific chemical resistance recommendations.

Materials

316# Stainless Steel

Pressure Rating

Sizes 1" to 2" 250 psi, 2½" to 4" 150 psi. Recommended working pressure ratings based on ambient temperature 70°F (21°C).

Branding

Example: Continental ContiTech GTM200SS

Order Codes

604-824 (stainless steel)

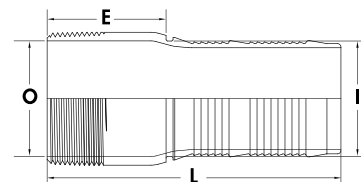

Insta-Lock™ Interlocking Stainless Steel Male NPT Hose Stem

Size	Stainless Steel
1	GTM100SS
1¼	GTM125SS
1½	GTM150SS
2	GTM200SS
2½	GTM250SS
2½	GTM3025SS
3	GTM300SS
4	GTM400SS

Size	Maximum OD (O)	Overall Length (L)	Exposed Length (E)	Minimum ID (I)
in.	in.	in.	in.	in.
1	1.315	4.375	1.750	0.830
1¼	1.660	4.500	1.875	1.130
1½	1.900	4.750	2.000	1.360
2	2.375	5.250	2.125	1.820
2½	2.875	6.125	2.625	2.240
3	3.500	7.000	2.625	2.730
4	4.500	7.625	3.000	3.710

Note: Continental ContiTech Insta-Lock™ fittings are never to be used in steam or compressed air service.

Insta-Lock™ Dust Cap

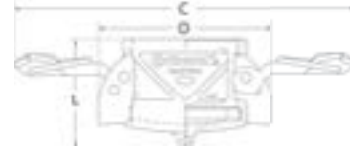

Product Specifications

Application

Dust cap is used to seal the pipe system and hose assemblies during non-use or transfer of assembly. Mating parts are the Part A, Part E and Part F.

Materials

Aluminum, 316# Stainless Steel and Brass (standard Nitrile gasket)

Branding

Example: Continental ContiTech DC200SS

Order Codes

650-831 (aluminum) 650-839 (brass)
650-847 (stainless steel)

Insta-Lock™ Dust Cap

Size	Aluminum	Stainless Steel	Brass
1/2	DC050AL	DC050SS	DC050BR
3/4	DC075AL	DC075SS	DC075BR
1	DC100AL	DC100SS	DC100BR
1¼	DC125AL	DC125SS	DC125BR
1½	DC150AL	DC150SS	DC150BR
2	DC200AL	DC200SS	DC200BR
2½	DC250AL	DC250SS	DC250BR
3	DC300AL	DC300SS	DC300BR
4	DC400AL	DC400SS	DC400BR
5	DC500AL	DC500SS	DC500BR
6	DC600AL	DC600SS	DC600BR

Size	Max. Width with Cam Arms Closed (O)	Overall Length (L)	OD with Cam Arms Extended (C)	Distance Chain Lug Extends from Body
in.	in.	in.	in.	in.
1/2	2.469	1.625	4.969	0.375
3/4	2.781	1.625	5.261	0.375
1	2.920	2.086	5.367	0.375
1¼	3.510	2.360	7.669	0.375
1½	3.830	2.400	7.967	0.375
2	4.210	2.633	8.340	0.375
2½	4.720	2.786	8.837	0.375
3	5.680	2.957	10.435	0.375
4	6.780	3.134	11.538	0.375
5	7.813	3.219	12.571	0.375
6	9.344	3.500	16.096	0.375

Note: Continental ContiTech Insta-Lock™ fittings are never to be used in steam or compressed air service. Continental ContiTech Insta-Lock™ Cam Arms are designed exclusively for Insta-Lock™ fittings.

Warning: Dust Caps and Dust Plugs are not to be used in pressure applications for safety and environmental reasons.

Air & Multipurpose

General Purpose
Heavy Duty
Push-on

Chemical Transfer

Cleaning Equipment

Food
Transfer
Washdown

Marine

Material Handling

Abrasives
Bulk Transfer
Cement & Concrete

Mining

Petroleum

Aircraft Fueling
Dispensing
Dock
Transfer

Spray

Steam

Vacuum

LPG Delivery

Water
Discharge
Suction & Discharge
Washdown

Welding

Coupling Systems

Equipment

Appendix

Insta-Lock™ Dust Plug

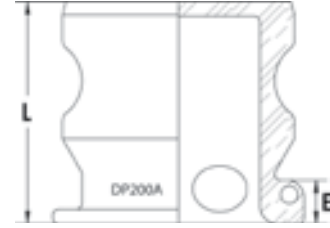

Product Specifications

Application

Dust plugs are used to seal the pipe system and hose assemblies during non-use or transfer of assembly. Mating parts are the Part C, Part B and Part D.

Materials

Aluminum, 316# Stainless Steel and Brass

Branding

Example: Continental ContiTech DP200SS

Order Codes

650-832 (aluminum), 650-840 (brass),
650-848 (stainless steel)

Insta-Lock™ Dust Plug

Size	Aluminum	Stainless Steel	Brass
1/2	DP050AL	DP050SS	DP050BR
3/4	DP075AL	DP075SS	DP075BR
1	DP100AL	DP100SS	DP100BR
1¼	DP125AL	DP125SS	DP125BR
1½	DP150AL	DP150SS	DP150BR
2	DP200AL	DP200SS	DP200BR
2½	DP250AL	DP250SS	DP250BR
3	DP300AL	DP300SS	DP300BR
4	DP400AL	DP400SS	DP400BR
5	DP500AL	DP500SS	DP500BR
6	DP600AL	DP600SS	DP600BR

Size	Overall Length (L)	Exposed Length (E)
in.	in.	in.
1/2	1.531	0.500
3/4	1.563	0.500
1	1.843	0.469
1¼	2.125	0.469
1½	2.156	0.469
2	2.375	0.469
2½	2.437	0.469
3	2.500	0.469
4	2.559	0.469
5	2.594	0.469
6	2.781	0.469

Note: Continental ContiTech Insta-Lock™ fittings are never to be used in steam or compressed air service.

Warning: Dust Caps and Dust Plugs are not to be used in pressure applications for safety and environmental reasons.

Air & Multipurpose

General Purpose
Heavy Duty
Push-on

Chemical Transfer

Cleaning Equipment

Food
Transfer
Washdown

Marine

Material Handling
Abrasives
Bulk Transfer
Cement & Concrete

Mining

Petroleum
Aircraft Fueling
Dispensing
Dock
Transfer

Spray

Steam

Vacuum

LPG Delivery

Water
Discharge
Suction & Discharge
Washdown

Welding

Coupling Systems

Equipment

Appendix

Insta-Lock™ Repair Kits



Product Specifications

Application

316# Stainless Steel and Brass

Materials

1 handle, 1 finger ring, 1 pin

Order Codes

605-855 (stainless steel), 605-856 (brass)

Part Number System

First 3 digits = Size

S = Stainless Steel

B = Brass

C = Continental ContiTech Insta-Lock™ Handle

M = Music Wire Ring

P = Pin

Insta-Lock™ Repair Kits

Size	Stainless Steel Handles	Brass Handles
in.	in.	in.
1/2	050SGMP	050BGMP
3/4	100SGMP	100BGMP
1	100SGMP	100BGMP
1¼	125SGMP	125BGMP
1½	150SGMP	150BGMP
2	200SGMP	200BGMP
2½	250SGMP	250BGMP
3	300SGMP	300BGMP
4	300SGMP	300BGMP
5	300SGMP	300BGMP
6	600SGMP	600BGMP

Air & Multipurpose

General Purpose
Heavy Duty
Push-on

Chemical Transfer

Cleaning Equipment

Food

Transfer
Washdown

Marine

Material Handling

Abrasives
Bulk Transfer
Cement & Concrete

Mining

Petroleum

Aircraft Fueling
Dispensing
Dock
Transfer

Spray

Steam

Vacuum

LPG Delivery

Water

Discharge
Suction & Discharge
Washdown

Welding

Coupling Systems

Equipment

Appendix

Insta-Lock™ Gaskets

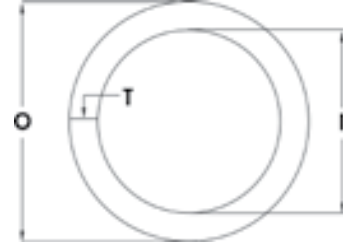

Product Specifications

Materials

Nitrile, Viton®, Teflon® Encapsulated Viton®, White Neoprene, Neoprene, Silicone

Order Codes

650-849 (Nitrile), 650-850 (Viton®), 650-851 (Teflon®),
650-852 (White Neoprene), 650-853 (Neoprene), 650-854 (Silicone)

Part Number System

G = Gasket
First 3 digits = Size of Gasket
Letters = Gasket Material Code

Insta-Lock™ Gaskets

Size	OD (O)	ID (I)	Thickness (T)
1/2	1.031	0.688	0.156
3/4	1.375	0.875	0.218
1	1.563	1.062	0.250
1¼	1.938	1.359	0.250
1½	2.188	1.625	0.250
2	2.625	2.000	0.250
2½	3.125	2.375	0.250
3	3.719	3.000	0.250
4	4.875	4.000	0.250
5	5.906	4.875	0.250
6	7.063	6.000	0.250

Size	Nitrile	Viton	Teflon Encapsulated Viton	White Neoprene	Neoprene	Silicone
in.	in.	in.	in.	in.	in.	in.
1/2	G050BN	G050VT	G050TE	G050WN	G050NE	G050SL
3/4	G075BN	G075VT	G075TE	G075WN	G075NE	G075SL
1	G100BN	G100VT	G100TE	G100WN	G100NE	G100SL
1¼	G125BN	G125VT	G125TE	G125WN	G125NE	G125SL
1½	G150BN	G150VT	G150TE	G150WN	G150NE	G150SL
2	G200BN	G200VT	G200TE	G200WN	G200NE	G200SL
2½	G250BN	G250VT	G250TE	G250WN	G250NE	G250SL
3	G300BN	G300VT	G300TE	G300WN	G300NE	G300SL
4	G400BN	G400VT	G400TE	G400WN	G400NE	G400SL
5	G500BN	G500VT	G500TE	G500WN	G500NE	G500SL
6	G600BN	G600VT	G600TE	G600WN	G600NE	G600SL

Nitrile = BN; Black
Teflon® = TE; White/Black with yellow stripe

Neoprene = NE; Black with red stripe
Viton® = VT; Black with yellow stripe

White Neoprene = WN; White
Silicone = SL; Red

Viton® is a registered trademark of DuPont Dow Elastomers L.L.C.

Teflon® is a registered trademark of E.I. du Pont de Nemours and Company.

Air & Multipurpose

General Purpose
Heavy Duty
Push-on

Chemical Transfer

Cleaning Equipment

Food
Transfer
Washdown

Marine

Material Handling
Abrasives
Bulk Transfer
Cement & Concrete

Mining

Petroleum
Aircraft Fueling
Dispensing
Dock
Transfer

Spray

Steam

Vacuum

LPG Delivery

Water
Discharge
Suction & Discharge
Washdown

Welding

Coupling Systems

Equipment

Appendix

Insta-Lock™ Interlocking Ferrules



Product Specifications

Materials

304# Stainless Steel
Plated Carbon Steel

Part Number System

FRSS200244 or FRCS200244

FR = Ferrule; SS = Stainless Steel; CS = Plated Carbon Steel

First 3 digits = Inside Diameter of Hose

Fourth digit = Inside Diameter of Ferrule in inches.

Fifth & sixth digits = Inside Diameter of Ferrule in 64ths of an inch.

Insta-Lock™ Interlocking Ferrules

Stainless Steel				Plated Carbon Steel			
1"	FRSS100124	2"	FRSS200232	3"	FRSS300332	1½"	FRCS150208
	FRSS100128		FRSS200236		FRSS300336		FRCS150212
	FRSS100132		FRSS200240		FRSS300340		FRCS150216
	FRSS100136		FRSS200244		FRSS300344		
	FRSS100140		FRSS200248		FRSS300348	2"	FRCS200232
			FRSS200252		FRSS300352		FRCS200236
1¼"	FRSS125144		FRSS200256		FRSS300356		FRCS200240
	FRSS125148		FRSS200260		FRSS300360		FRCS200244
	FRSS125152				FRSS300400		FRCS200248
	FRSS125156	2½"	FRSS250256		FRSS300404		
			FRSS250260			3"	FRCS300336
1½"	FRSS150156		FRSS250300	4"	FRSS400436		FRCS300340
	FRSS150160		FRSS250304		FRSS400440		FRCS300344
	FRSS150200		FRSS250308		FRSS400444		FRCS300348
	FRSS150204		FRSS250312		FRSS400448		
	FRSS150208		FRSS250316		FRSS400452	4"	FRCS400444
	FRSS150212		FRSS250320		FRSS400456		FRCS400448
	FRSS150216		FRSS150224		FRSS400460		FRCS400452
	FRSS150220				FRSS400500		
					FRSS400504		

Air & Multipurpose

General Purpose
Heavy Duty
Push-on

Chemical Transfer

Cleaning Equipment

Food

Transfer
Washdown

Marine

Material Handling

Abrasives
Bulk Transfer
Cement & Concrete

Mining

Petroleum

Aircraft Fueling
Dispensing
Dock
Transfer

Spray

Steam

Vacuum

LPG Delivery

Water

Discharge
Suction & Discharge
Washdown

Welding

Coupling Systems

Equipment

Appendix

Stainless Steel & Aluminum Crimp Sleeves for Infinity™/Paladin® Hoses



Product Specifications

Materials

304# Stainless Steel Aluminum

Part Number System

CSSS300400

CS = Crimp Sleeves SS = Stainless Steel SAL = Aluminum

First 3 digits = Inside Diameter of Hose

Fourth digit = Inside Diameter of Sleeve in inches.

Fifth & sixth digits = Inside Diameter of Sleeve in 64ths of an inch.

Infinity™ and Paladin® Crimp Sleeves

Size	Stainless Steel Handles	Brass Handles
in.	part #	part #
2	CSSS200300	SAL200260
3	CSSS300400	SAL300360
4	CSSS400500	SAL400460

Air & Multipurpose
General Purpose
Heavy Duty
Push-on

Chemical Transfer

Cleaning Equipment

Food
Transfer
Washdown

Marine

Material Handling
Abrasives
Bulk Transfer
Cement & Concrete

Mining

Petroleum
Aircraft Fueling
Dispensing
Dock
Transfer

Spray

Steam

Vacuum

LPG Delivery

Water
Discharge
Suction & Discharge
Washdown

Welding

Coupling Systems

Equipment

Appendix

Pressure Washer Fittings



Product Specifications

Application

1/4" and 3/8" bite to wire pressure washer fittings. Only for use with the following Continental ContiTech pressure washer hose specs: Fortress® 3000, Neptune™ 3000, Neptune™ 4001-R, Neptune™ 4500, Gauntlet® 3000, Gauntlet® 4500, Galvanator® 3000 and Neptune™ 6000.

Materials

Steel, yellow zinc diachromate finish

Branding

Non-branded

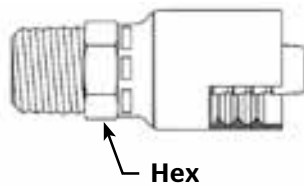

NPTF Male Solid

SAP	Hose Size in.	Thread Size in.
20221742	1/4	1/4-18
20190045	3/8	3/8-18F250BR

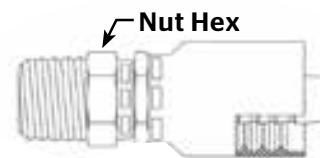

NPTF Male Swivel

SAP	Hose Size in.	Thread Size in.
20221743	1/4	1/4-18
20190047	3/8	3/8-18

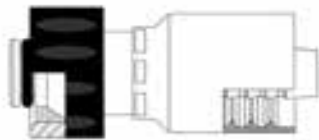

SAP

Order Code	Hose Size in.	Thread Size in.
20207707	3/8	22 x 1.5

Air & Multipurpose
General Purpose
Heavy Duty
Push-on

Chemical Transfer

Cleaning Equipment

Food
Transfer
Washdown

Marine

Material Handling
Abrasives
Bulk Transfer
Cement & Concrete

Mining

Petroleum
Aircraft Fueling
Dispensing
Dock
Transfer

Spray

Steam

Vacuum

LPG Delivery

Water
Discharge
Suction & Discharge
Washdown

Welding

Coupling Systems

Equipment

Appendix

Equipment



Air & Multipurpose

- General Purpose
- Heavy Duty
- Push-on

Chemical Transfer

Cleaning Equipment

Food

- Transfer
- Washdown

Marine

Material Handling

- Abrasives
- Bulk Transfer
- Cement & Concrete

Mining

Petroleum

- Aircraft Fueling
- Dispensing
- Dock Transfer

Spray

Steam

Vacuum

LPG Delivery

Water

- Discharge
- Suction & Discharge
- Washdown

Welding

Coupling Systems

Equipment

Appendix

	Page
PC125	291
PC125M	290
PC150	292
PC150H	293
PC200-P	294
PC400-P	295
PC600L-P	296
PC1000-P	297
PC1200-P	298-299
PCTB1500/2500	300

PC125M

Description

Carried to the job site with a handle and support stand, the PC125M is ideal for portable crimping requirements. Whether carried on-site or used in a vehicle, or even stationary at the shop, the PC125M is designed as a low-volume crimper or for occasional use. Crimp diameter is set and controlled with an easy-to-read micrometer. This affordable crimper is packaged in component parts to fit the need of the user. The PC125M has three power options. No electrical power source is required if using the hand or pneumatic pump option. A 1/2-HP, 110V electric pump is available as well. The PC125M includes die ring pusher, stand, compression ring, pressure plate and a metric micrometer. Pumps and dies are purchased separately.



PC125M

Features

- › Easy-to-read, fully adjustable metric micrometer allows precise setting of crimp diameters to an accuracy of +/- .1mm
- › Open design with vertical feed for good operator visibility
- › Removable pusher and spring-loaded die set for easy loading
- › 60-ton cylinder
- › Two-piece, "slide in" die design for easy installation
- › Lightweight for portable field use
- › Color-coded die sets to speed die selection and setup
- › Attach hand, air or electric pump

Capability

- › 1/4" through 1e" ID 2-braid hose and 1e" ID 4-spiral hose with all coupling end styles including most bent tubes

Power Source

- › Optional Two Stage Hand Pump, 10,000 psi (PC125-HPump)
- › Optional Air/Hydraulic Pump, 10,000 psi using 80 psi air (PC125-PPump)
- › Optional 1/2-HP, 110V AC, single phase, 50-60 Hz Electric Pump (PC125M-.5EPump) with foot switch

Oil Capacity: 1 gallon

Mounting: Stand included

Dimensions: 14" L x 11" W x 23.5" H

Weight: 45 lbs.

Dies

Part Number	ID	Part Number	ID
PC125 - 8.5 Black	8.5mm	PC125 - 27 Brown	27mm
PC125 - 12 Black	12mm	PC125 - 31 Silver	31mm
PC125 - 14 Red	14mm	PC125 - 34 Purple	34mm
PC125 - 16 Blue	16mm	PC125 - 41 Orange	41mm
PC125 - 19 Green	19mm	PC125 - 45 Black	45mm
PC125 - 23 Yellow	23mm	PC125 - 50 Black	50mm

Options

- › PC125M - Kit includes the PC125M crimper and 7 die sets including 16mm, 19mm, 23mm, 27mm, 31mm, 34mm and 41mm dies for 1/4" to 1" 1-braid and 2-braid hose
- › PC125 - Shelf-Black Die Storage Shelf Unit 13" deep x 12.5" wide x 15" high, 12 lbs.
- › PC125 - Hpump - Two Stage Hand Pump
- › PC125 - Ppump - Air/Hydraulic Pump
- › PC125M - .5EPump - 1/2 HP, 110V Electric Pump

Replacement Parts

- › PC125M - Pusher - Die Ring Pusher
- › PC125 - Cring - Compression Ring
- › PC125 - Pplate - Pressure Plate
- › PC125 - Die Screw - Die Screw
- › PC125 - Die Spring - Die Spring
- › PC125 - Hpump - Optional Two Stage Hand Pump
- › PC125 - Ppump - Optional Air/Hydraulic Pump
- › PC125M - .5EPump - Optional 1/2 HP, 110V Electric Pump
- › PC900 - Grease-3 oz. - High-pressure grease in a 3 oz. tube
- › PC900 - Grease-1 lb. - High-pressure grease in a 1 lb. can
- › PC900 - AerosolLube - High-pressure grease in an aerosol can



Electric Pump (PC125M-.5EPump)



Metric Micrometer



PC125 Die Set



Air/Hydraulic Pump (PC125-PPump)



PC125 Die Storage Shelf



Hand Pump (PC125 HPump)

Information in this supersedes all previously printed material and is current as of September 2014. Due to continual product improvements, Continental ContiTech reserves the right to alter specs without prior notice. For the most current product information, visit www.contitech.us.

Air & Multipurpose

General Purpose
Heavy Duty
Push-on

Chemical Transfer

Cleaning Equipment

Food
Transfer
Washdown

Marine

Material Handling
Abrasives
Bulk Transfer
Cement & Concrete

Mining

Petroleum
Aircraft Fueling
Dispensing
Dock
Transfer

Spray

Steam

Vacuum

LPG Delivery

Water
Discharge
Suction & Discharge
Washdown

Welding

Coupling Systems

Equipment

Appendix

PC125

Air & Multipurpose

- General Purpose
- Heavy Duty
- Push-on

Chemical Transfer

Cleaning Equipment

- Food Transfer
- Washdown

Marine

Material Handling

- Abrasives
- Bulk Transfer
- Cement & Concrete

Mining

Petroleum

- Aircraft Fueling
- Dispensing
- Dock Transfer

Spray

Steam

Vacuum

LPG Delivery

Water

- Discharge
- Suction & Discharge
- Washdown

Welding

Coupling Systems

Equipment

Appendix

Description

The PC125 portable crimper, with its open design, removable pusher and easy-to-use, spring-loaded die set, is designed for higher production volume and repetitive use. Crimp diameter is set and controlled with an easy-to-read micrometer. The PC125 is packaged for shop service and includes the crimper and 1-HP, 110V electric pump on a common base, compression ring, pressure plate, magnetized die ring pusher, stop/start remote pendant switch, metric micrometer, adjustable coupling stop and adjustable retraction stop.



PC125

Features

- › Easy-to-read, fully adjustable metric micrometer allows precise setting of crimp diameters to an accuracy of +/-1mm
- › Open design with vertical feed for good operator visibility
- › Removable pusher and spring-loaded die set for easy loading
- › Magnetized pusher to attach compression ring for repetitive use
- › 60-ton cylinder
- › Automatic shutoff for precise crimps
- › Adjustable retraction stop limits ram retractions for quick repetitive crimps
- › Adjustable coupling stop for accurate, repetitive positioning of the assembly inside the dies
- › Two-piece, "slide in" die design for easy installation
- › Common base for bench mounting
- › Color-coded die sets to speed die selection and setup
- › 1-HP, 110V pump
- › Pneumatic activation (no electric wires) of remote pendant switch

Capability

- › 1/4" through 1 1/4" ID 2-braid hose and 1 1/4" ID 4-spiral hose with all coupling end styles including most bent tubes

Power Source

- › 1-HP, 110V AC, single phase, 50-60 Hz, Electric Pump (PC125/150-E1PUMP) with pneumatic stop/start pendant switch

Oil Capacity: 1 gallon

Mounting: Crimper and pump installed on plate

Dimensions: 20" L x 11" W x 19" H

Weight: 125 lbs.

Dies

Part Number	ID	Part Number	ID
PC125 - 8.5 Black	8.5mm	PC125 - 27 Brown	27mm
PC125 - 12 Black	12mm	PC125 - 31 Silver	31mm
PC125 - 14 Red	14mm	PC125 - 34 Purple	34mm
PC125 - 16 Blue	16mm	PC125 - 41 Orange	41mm
PC125 - 19 Green	19mm	PC125 - 45 Black	45mm
PC125 - 23 Yellow	23mm	PC125 - 50 Black	50mm

Options

- › PC125-Kit includes the PC125 crimper and 7 die sets including 16mm, 19mm, 23mm, 27mm, 31mm, 34mm and 41mm dies for 1/4" to 1" 1-braid and 2-braid hose
- › PC125-Shelf - Black Die Storage Shelf Unit 13" deep x 12.5" wide x 15" high, 12 lbs.

Replacement Parts

- › PC125 - Pusher - Die Ring Pusher With Magnets
- › PC125 - Cring - Compression Ring
- › PC125 - Pplate - Pressure Plate
- › PC125 - Cstop - Adjustable Coupling Stop
- › PC125 - Die Screw - Die Screw
- › PC125 - Die Spring - Die Spring
- › PC125/150 - Switch - Pneumatic Start/Stop Pendant Switch for 1 HP Pump
- › PC125/150 - E1Pump - 1 HP 110V Electric Pump
- › PC900 - Grease-3 oz. - High-pressure grease in a 3 oz. tube
- › PC900 - Grease-1 lb. - High-pressure grease in a 1 lb. can
- › PC900 - AerosolLube-High-pressure grease in an aerosol can



Metric Micrometer



PC125 Die Storage Shelf



PC125 Die Set



PC125 Coupling Stop



PC125 Retraction Stop



PC125 Magnetic Pusher

Information in this supersedes all previously printed material and is current as of September 2014. Due to continual product improvements, Continental ContiTech reserves the right to alter specs without prior notice. For the most current product information, visit www.contitech.us.

PC150 Series Including PC150-1 & PC150-2

Description

The PC150-2 is a stationary crimper with more power to manufacture factory-quality hose assemblies quickly and easily. Its open design with removable pusher and "slide in" die configuration allow for good visibility and easy loading of dies and hose assemblies. Crimp diameter is set and controlled with an easy-to-read micrometer. Designed to handle higher volumes in a shop environment, the PC150-2 includes the crimper and 2-HP pump on a common base, pressure plate, compression ring, die ring pusher, stop/start remote pendant switch, metric micrometer, adjustable coupling stop, adjustable retraction stop and work light. The optional PC150-1 includes all the components of the PC150-2 and a 1-HP pump.



Features

- › Easy-to-read, fully adjustable metric micrometer allows precise setting of crimp diameters to an accuracy of +/- .1mm
- › Open design with vertical feed for good operator visibility
- › Removable pusher and spring-loaded die set for easy loading
- › 80-ton cylinder
- › Automatic shutoff for precise crimps
- › Adjustable retraction stop limits ram retractions for quick repetitive crimps
- › Adjustable coupling stop for accurate, repetitive positioning of the assembly inside the dies
- › Two-piece, "slide in" die set for easy installation
- › Common base for bench mounting
- › Color-coded die sets to speed die selection and setup
- › 2-HP, 220V pump
- › Pneumatic activation (no electric wires) of remote pendant switch

Capability

- › 1/4" through 1 1/2" ID 2-braid hose and 4-spiral hose with all coupling end styles including most bent tubes

Power Source

- › 2-HP, 220V AC, single phase, 50-60 Hz Electric Pump (PC150-E2Pump) for PC150-2 crimper
- › Optional 1-HP, 110V AC, single phase, 50-60 Hz Electric Pump (PC125/150-E1Pump) for PC150-1 crimper

Oil Capacity: 1 gallon

Mounting: Crimper and pump installed on plate

Dimensions: 32" L x 16.5" W x 29" H

Weight: 275 lbs.

Dies

Part Number	ID	Part Number	ID
PC150 - 8.5 Black	8.5mm	PC150 - 27 Brown	27mm
PC150 - 12 Black	12mm	PC150 - 31 Silver	31mm
PC150 - 14 Red	14mm	PC150 - 34 Purple	34mm
PC150 - 16 Blue	16mm	PC150 - 41 Orange	41mm
PC150 - 19 Green	19mm	PC150 - 45 Black	45mm
PC150 - 23 Yellow	23mm	PC150 - 50 Black	50mm
PC150 - 27 Brown	27mm	PC150 - 56 Black	56mm

Options

- › PC150 - 1 Kit includes PC150-1 crimper and 7 die sets including 16mm, 19mm, 23mm, 31mm, 41mm, 50mm and 56mm dies for 1/4" to 1 1/2" 1-braid to 4-spiral hose
- › PC150 - 2 Kit includes PC150-2 crimper and 7 die sets including 16mm, 19mm, 23mm, 31mm, 41mm, 50mm and 56mm dies for 1/4" to 1 1/2" 1-braid to 4-spiral hose
- › PC150 - Shelf - Black Die Storage Shelf Unit 15" deep x 20.5" wide x 16" high, 25 lbs.
- › PC150 - Spacer - Spacer Kit for Elbows
- › PC150 - 1 with 1 HP Pump
- › PC150 - 2 with 2 HP Pump

Replacement Parts

- › PC150 - Pusher - Die Ring Pusher
- › PC150 - Cring - Compression Ring
- › PC150 - Pplate - Pressure Plate
- › PC150 - Cstop - Adjustable Coupling Stop
- › PC150 - Die Screw - Die Screw
- › PC150 - Die Spring - Die Spring
- › PC125/150 - Switch - Pneumatic Start/Stop Pendant Switch for 1-HP or 2-HP Pump
- › PC150 - E2Pump - 2-HP Electric Pump for PC150-2 Crimper
- › PC125/150 - E1Pump - 1-HP Electric Pump for PC150-1 Crimper
- › PC900 - Grease-3 oz.-High-pressure grease in a 3 oz. tube
- › PC900 - Grease-1 lb.-High-pressure grease in a 1 lb. can
- › PC900-AerosolLube-High-pressure grease in an aerosol can



PC150 Coupling Stop



PC150 Die Set



PC150 Die Storage Shelf



PC150 Retraction Stop

Information in this supersedes all previously printed material and is current as of September 2014. Due to continual product improvements, Continental ContiTech reserves the right to alter specs without prior notice. For the most current product information, visit www.contitech.us.

Air & Multipurpose

General Purpose
Heavy Duty
Push-on

Chemical Transfer

Cleaning Equipment

Food
Transfer
Washdown

Marine

Material Handling
Abrasives
Bulk Transfer
Cement & Concrete

Mining

Petroleum
Aircraft Fueling
Dispensing
Dock
Transfer

Spray

Steam

Vacuum

LPG Delivery

Water
Discharge
Suction & Discharge
Washdown

Welding

Coupling Systems

Equipment

Appendix

PC150H Series Including PC150H-1 & PC150H-2

Air & Multipurpose

- General Purpose
- Heavy Duty
- Push-on

Chemical Transfer

Cleaning Equipment

- Food Transfer
- Washdown

Marine

- Material Handling**
- Abrasives
- Bulk Transfer
- Cement & Concrete

Mining

- Petroleum**
- Aircraft Fueling
- Dispensing
- Dock Transfer

Spray

Steam

Vacuum

LPG Delivery

- Water**
- Discharge
- Suction & Discharge
- Washdown

Welding

Coupling Systems

Equipment

Appendix

Description

The PC150H offers the ease of use of a horizontal crimper with the power and precise adjustment capabilities usually found in more costly models. With the same crimping capability as the PC150 Series, the "H" model offers hose feed horizontally from either front or rear through a large 4.9 inch throat opening. The PC150H can be ordered with a 1-HP electric pump (PC150H-1) or a 2-HP electric pump (PC150H-2), producing maximum force in a small package. The PC150H makes repetitive crimps fast and easy to accomplish with a precise, direct-read digital adjustment and a built-in cylinder retraction stop. The PC150H also offers convenience features found in both our vertical and horizontal crimpers including a pneumatic start/stop pendant switch, a magnetic die change tool, an optional die rack for storing dies and master die grease fittings as a special feature for easy lubrication.



PC150H

Features

- › Easy-to-read micrometer provides precise crimp settings
- › Hose feed is horizontal from both front and rear
- › Easy die loading with magnetic die change tool
- › Maximum die size 56mm
- › 155-ton crimping force
- › Automatic shutoff for precise crimps
- › Retraction stop limits die travel for faster repetitive crimps
- › Large 13-quart oil reservoir to cool components during repetitive crimps
- › Pneumatic activation using remote pendant switch
- › 1-HP and 2-HP power options

Capability

- › 1/4" through 1/2" ID 2-braid hose and 4-spiral hose with all coupling styles and most bent tubes

Power Source

- › 1-HP, 110V AC, single phase (PC150H-1)
- › 2-HP, 220V AC, single phase (PC150H-2)

Oil Capacity: 13 quarts

Mounting: Bench or cabinet

Dimensions: 15.0" L x 23.5" W x 20.5" H

Weight: 245 lbs.

Dies

Part Number	ID	Part Number	ID
PC150H-8.5	8.5mm	PC150H-31	31mm
PC150H-12	12mm	PC150H-34	34mm
PC150H-14	14mm	PC150H-41	41mm
PC150H-16	16mm	PC150H-45	45mm
PC150H-19	19mm	PC150H-50	50mm
PC150H-23	23mm	PC150H-56	56mm
PC150H-27	27mm		

Options

- › PC150H - 1 Kit includes the PC150H-1 crimper and 7 die sets including 16mm, 19mm, 23mm, 31mm, 41mm, 50mm and 56mm
- › PC150H - 2 Kit includes the PC150H-2 crimper and 7 die sets including 16mm, 19mm, 23mm, 31mm, 41mm, 50mm and 56mm
- › PC150H-Rack - Black die cabinet 7" deep x 13" wide x 18" high, holds 9 dies

Replacement Parts

- › PC900 - Grease-1lb. - High-pressure grease in 1 lb. can
- › PC900 - AerosolLube - High-pressure grease in an aerosol can
- › PC125/150 Switch - Pneumatic Start/Stop Pendant Switch for 1 - HP or 2 - HP Pump
- › PC150H-DCT - Die Change Tool



PC150H Die Set



Die Change Tool



PC150H Die Rack



Digital Gauge

Information in this supersedes all previously printed material and is current as of September 2014. Due to continual product improvements, Continental ContiTech reserves the right to alter specs without prior notice. For the most current product information, visit www.contitech.us.

PC200-P Series including PC200-1, PC200-2 & PC200-3

Description

The PC200-P is a high-volume, high-capacity stationary crimper utilizing microprocessor control for the fastest, most accurate crimping system available. Crimp settings, dwell time, pre-set start positions and auto/manual operation are all easily set with electronic controls. This production crimper is a quick and easy way to make factory-quality hose assemblies. The standard package is the PC200-P crimper, which includes a 7.5-HP, 230V/3 phase pump and foot pedal. The optional PC200-2 crimper includes a 7.5-HP, 480V/3 phase pump and foot pedal. The optional PC200-3 (single phase) crimper includes a 5-HP, 220V/single phase pump and foot pedal.



PC200-1

Features

- › Hose feed is horizontal from both front or rear
- › Accurate electronic PLC crimp diameter adjustment
- › Manual or automatic model
- › Max die size +78 mm
- › 340-ton cylinder
- › Automatic shutoff for precise crimps
- › Power return stroke and return limit control
- › Rapid retraction of die fingers through hydraulic system
- › Die sets easily changed using hand tool.
- › Accommodates bent tube/elbow couplings with the ability of installing 2", 90-degree fittings on both ends

Capability

- › 1/4" through 2" ID 2-braid hose and 2" 6-spiral hose with all coupling end styles including most bent tubes

Power Source

- › 7.5-HP, 230V AC, 3 phase, 60 Hz (PC200-E7.5-1Pump)
- › Optional 7.5-HP, 480V AC, 3 phase, 60 Hz (PC200-E7.5-2 Pump) for the PC200-2 crimper
- › Optional 5-HP, 220V AC, single phase, 60 Hz for the PC200-3 crimper

Oil Capacity: 8 gallons

Mounting: Bench or cabinet

Dimensions: 18.5" L x 27.5" W x 31.5" H (without die cabinet)

Weight: 573 lbs. (excluding cabinet)

Dies

Part Number	ID	Part Number	ID
PC200 - 8.5	8.5mm	PC200 - 41	41mm
PC200 - 12	12mm	PC200 - 45	45mm
PC200 - 14	14mm	PC200 - 50	50mm
PC200 - 16	16mm	PC200 - 56	56mm
PC200 - 19	19mm	PC200 - 62	62mm
PC200 - 23	23mm	PC200 - 69	69mm
PC200 - 27	27mm	PC200 - 74	74mm
PC200 - 31	31mm	PC200 - 78	78mm
PC200 - 34	34mm		

Options

- › PC200-P - 1 Kit includes the PC200-1 crimper and 10 die sets including 16mm, 19mm, 23mm, 31mm, 41mm, 50mm, 56mm, 62mm, 69mm and 78mm dies for 1/4" to 2" 1-braid to 6-spiral hose
- › PC200 - 2 Kit includes the PC200-2 crimper and 10 die sets including 16mm, 19mm, 23mm, 31mm, 41mm, 50mm, 56mm, 62mm, 69mm and 78mm dies for 1/4" to 2" 1-braid to 6-spiral hose
- › PC200 - 3 Kit includes the PC200-3 crimper and 10 die sets including 16mm, 19mm, 23mm, 27mm, 31mm, 34mm, 41mm, 50mm, 56mm and 69mm
- › PC200 - Rack - Black Die Cabinet 20" deep x 30" wide x 29" high
- › PC200 - MBS - Manual Back Stop
- › PC200 - EBS - Electric Back Stop

Replacement Parts

- › PC900 - Grease-1lb. - High-pressure grease in a 1 lb. can
- › PC900 - AerosolLube - High-pressure grease in an aerosol can



PC200 Die Set



Optional Automatic Back Stop



Control Panel



Foot Switch



Die Cabinet

Air & Multipurpose

General Purpose
Heavy Duty
Push-on

Chemical Transfer

Cleaning Equipment

Food

Transfer
Washdown

Marine

Material Handling

Abrasives
Bulk Transfer
Cement & Concrete

Mining

Petroleum

Aircraft Fueling
Dispensing
Dock
Transfer

Spray

Steam

Vacuum

LPG Delivery

Water

Discharge
Suction & Discharge
Washdown

Welding

Coupling Systems

Equipment

Appendix

Information in this supersedes all previously printed material and is current as of September 2014. Due to continual product improvements, Continental ContiTech reserves the right to alter specs without prior notice. For the most current product information, visit www.contitech.us.

PC400-P Series Including PC400-P & PC400-1P

Air & Multipurpose

- General Purpose
- Heavy Duty
- Push-on

Chemical Transfer

Cleaning Equipment

- Food
- Transfer
- Washdown

Marine

- Material Handling**
- Abrasives
- Bulk Transfer
- Cement & Concrete

Mining

- Petroleum**
- Aircraft Fueling
- Dispensing
- Dock
- Transfer

Spray

Steam

Vacuum

LPG Delivery

- Water**
- Discharge
- Suction & Discharge
- Washdown

Welding

Coupling Systems

Equipment

Appendix

Description

The PC400-P is a high-volume, high-capacity stationary crimper utilizing microprocessor control for the fastest, most accurate crimping system available. Crimp settings, dwell time, pre-set start positions and auto/manual operation are all easily set with electronic controls. This production crimper is a quick and easy way to make both hydraulic and industrial hose assemblies. The standard package is the PC400-P crimper which includes a 7.5-HP, 230V/3 phase pump and foot pedal. The optional PC400-1 crimper includes a 5-HP, 230V/single phase pump and foot pedal.



PC400

Features

- › Hose feed is horizontal from both front or rear
- › Accurate electronic PLC crimp diameter adjustment
- › Manual or automatic model
- › Maximum die opening: die closed diameter + 78mm (hydraulic) and 122mm (industrial)
- › 265-ton cylinder
- › Automatic shutoff for precise crimps
- › Power return stroke and return limit control
- › Rapid retraction of die fingers through hydraulic system
- › Die sets easily changed using hand tool
- › Accommodates bent tube/elbow couplings with the ability of installing 2", 90-degree fittings on both ends

Capability

- › 1/4" through 2" ID 2-braid hose, and 2" 6-spiral hose and 4" industrial hose with all coupling end styles including most bent tubes
- › 1/2" through 4" ID industrial hose

Power Source

- › 7.5-HP, 230V AC, 3 phase, 60 Hz for the PC400 crimper
- › Optional 5-HP, 230V AC, single phase for the PC400-1 crimper

Oil Capacity: 8 gallons

Mounting: Bench or cabinet

Dimensions: 18.5" L x 27.5" W x 31.5" H (without die cabinet)

Weight: 573 lbs. (excluding cabinet)

Hydraulic Dies (PC400 utilizes PC200 dies)

Part Number	ID	Part Number	ID
PC200 - 8.5	8.5mm	PC200 - 34	34mm
PC200 - 12	12mm	PC200 - 41	41mm
PC200 - 14	14mm	PC200 - 45	45mm
PC200 - 16	16mm	PC200 - 50	50mm
PC200 - 19	19mm	PC200 - 56	56mm
PC200 - 23	23mm	PC200 - 62	62mm
PC200 - 27	27mm	PC200 - 69	69mm
PC200 - 31	31mm	PC200 - 74	74mm
		PC200 - 78	78mm

Industrial Dies

Part Number	ID	Part Number	ID
PC400 - 86-125L	86mm	PC400-114-125L	114mm
PC400 - 90-125L	90mm	PC400-118-125L	118mm

Options

- › PC400 - Kit includes the PC400 crimper and 12 die sets including 16mm, 19mm, 23mm, 27mm, 31mm, 34mm, 41mm, 50mm, 56mm, 62mm, 69mm and 78mm dies for 1/4" to 2" 1-braid to 6-spiral hose
- › PC400 - 1 Kit includes the PC400-1 crimper and 12 die sets including 16mm, 19mm, 23mm, 27mm, 31mm, 34mm, 41mm, 50mm, 56mm, 62mm, 69mm and 78mm dies for 1/4" to 2" 1-braid to 6-spiral hose
- › PC200 - Rack - Black Die Cabinet 20" deep x 30" wide x 29" high
- › PC200 - MBS - Manual Back Stop
- › PC200 - EBS - Electric Back Stop

Replacement Parts

- › PC900 - Grease -1lb. High-pressure grease in a 1 lb. can
- › PC900 - AerosolLube - High-pressure grease in an aerosol can



Control Panel



Foot Switch



Die Cabinet



Optional Automatic Back Stop

Information in this supersedes all previously printed material and is current as of September 2014. Due to continual product improvements, Continental ContiTech reserves the right to alter specs without prior notice. For the most current product information, visit www.contitech.us.

PC600L-P Crimper

Description

The PC600L-P is a high-volume, high-capacity stationary crimper utilizing the fully automatic ACT3™ microprocessor controller. The PC600L-P can produce 2,200 crimps per hour with 350 tons of crimping force to allow for both hydraulic and industrial hose assemblies, and it is ideal for production assembly applications. The standard PC600L-P crimper includes a 7.5-HP, 230 VAC, 3-phase hydraulic pump.

Features

- › Fully automatic ACT3™ controller
- › Manual and automatic operation
- › Utilizes the PC200/400 dies with easy-to-change die tool
- › 350-ton cylinder
- › Built-in heavy-duty base with die holders
- › Allows for 2,200 crimps per hour
- › Automatic shutoff for precise crimps
- › Power return stroke and return limit control

Capability

- › 1/4" through 2.5" ID, 2-braid and 6-spiral hydraulic hose
- › 3/16" through 6" ID industrial hose

Power Source

- › 7.5-HP, 230V AC, 3 phase, 60 Hz

Dimensions

- › Master die inside diameter - 145mm
- › Master die opening w/o dies - 273mm
- › Maximum swaging diameter - 192mm
- › Maximum die opening - Die+128mm
- › Pump size: 21" L x 34" W x 36.5" H
- › Pump weight: 450 lbs. (205kg)
- › Machine size: 22" L x 36" W x 57" H

Weight: 4,500 lbs. (2,041kg) die base/cabinet (shipping weight)

The following dies are included in the standard PC600-P Kit

Hydraulic Dies

SAP #	Descriptive #	Description
20244976	PC200-16	16mm Die
20244977	PC200-19	19mm Die
20244978	PC200-23	23mm Die
20244980	PC200-31	31mm Die
20244982	PC200-41	41mm Die
20244984	PC200-50	50mm Die
20244985	PC200-56	56mm Die
20244986	PC200-62	62mm Die
20244987	PC200-69	69mm Die
20249890	PC200-78	78mm Die



PC600



Optional Automatic Back Stop

Continental ContiTech Part Numbers

SAP #	Descriptive #	Description
20527520	PC600-P Skit	PC600-P Kit 16-23, 31, 41, 50, 56, 62, 69, 78
		Includes Hydraulic & Industrial Dies (Hyd: 16-23, 31, 41, 50, 56, 62, 69, 79) (Ind: 84, 92, 100, 125, 166, 178)
20548773	PC600-P Skit H&I	
20267266	PC200/400-DCT	Die Change Tool
20244972	PC200-EBS	Electric Back Stop (Optional)
20244971	PC200-MBS	Manual Back Stop

Air & Multipurpose

General Purpose
Heavy Duty
Push-on

Chemical Transfer

Cleaning Equipment

Food
Transfer
Washdown

Marine

Material Handling
Abrasives
Bulk Transfer
Cement & Concrete

Mining

Petroleum
Aircraft Fueling
Dispensing
Dock
Transfer

Spray

Steam

Vacuum

LPG Delivery

Water
Discharge
Suction & Discharge
Washdown

Welding

Coupling Systems

Equipment

Appendix

PC1000-P Crimper

Air & Multipurpose

- General Purpose
- Heavy Duty
- Push-on

Chemical Transfer

Cleaning Equipment

- Food
- Transfer
- Washdown

Marine

- Material Handling**
- Abrasives
- Bulk Transfer
- Cement & Concrete

Mining

- Petroleum**
- Aircraft Fueling
- Dispensing
- Dock
- Transfer

Spray

Steam

Vacuum

LPG Delivery

- Water**
- Discharge
- Suction & Discharge
- Washdown

Welding

Coupling Systems

Equipment

Appendix

Description

The PC1000-P is a high-volume, high-capacity stationary crimper utilizing the fully automatic ACT3™ microprocessor controller. The PC1000-P can produce 1,415 crimps per hour with 450 tons of crimping force to allow for both Hydraulic and Industrial hose assemblies, ideal for production assembly applications. The standard PC1000-P crimper includes a 7.5-HP, 230 VAC, 3-phase hydraulic pump.

Features

- › Fully automatic ACT3™ controller
- › Manual and automatic operation
- › Utilizes the PC200/400 dies with easy-to-change die tool
- › 350-ton cylinder
- › Built-in heavy-duty base with die holders
- › Allows for 1,415 crimps per hour
- › Automatic shutoff for precise crimps
- › Power return stroke and return limit control

Capability

- › Up through 2½" ID, 2-braid, 4-spiral and 6-spiral hydraulic hose
- › 3/16" through 10" ID industrial hose

Power Source

- › Standard: 7.5-HP, 230 VAC, 3 Phase, 60 Hz
- › Optional: 7.5-HP, 460 VAC, 3 Phase, 60 Hz

Dimensions

- › Master die inside diameter - 230mm
- › Master die opening w/o dies - 350mm
- › Maximum swaging diameter - 192mm
- › Maximum die opening - Die+125mm
- › Machine size: 30" L x 44" W x 74" H

Weight: 6,185 lbs. (2,806kg)

Continental ContiTech Part Numbers

SAP #	Descriptive #	Description
20588181	PC1000-PX Kit	PC1000-PX Kit

(3 phase 230V dies 14-245) PC1000 utilizes PC200/400/600 dies and change tool



PC1000

The following dies are included in the standard PC1000-PX Kit

Hydraulic Dies

SAP #	Descriptive #	Description
20244975	PC200-14	14mm Die
20244976	PC200-16	16mm Die
20244977	PC200-19	19mm Die
20244978	PC200-23	23mm Die
20244980	PC200-31	31mm Die
20244982	PC200-41	41mm Die
20244984	PC200-50	50mm Die
20244985	PC200-56	56mm Die
20244986	PC200-62	62mm Die
20244987	PC200-69	69mm Die
20249890	PC200-78	78mm Die
20562098	PC600-84	84mm Die
20562099	PC600-92	92mm Die
20562650	PC600-100	100mm Die
20562651	PC600-108	108mm Die
20562652	PC600-116	116mm Die
20562653	PC600-126	126mm Die
20590712	PC1000-166	166mm Die
20590713	PC1000-178	178mm Die
20590714	PC1000-215	215mm Die
20590715	PC1000-245	245mm Die

PC1200-P Industrial Crimper

The PC1200-P can be operated in manual mode for a single crimp or set up for fully automatic production crimping.

- › Hose capacity from 3 inch up to 14 inches industrial hose
- › The PC1200-P crimper opens to 19¼ inches permitting special and angled fittings to be handled easily
- › 7.5 HP dual stage pump
- › Industrial crimp calculator
- › Fully adjustable crimp diameter
- › Manual or automatic ACT™ controls
- › Enter crimp diameter in either inch or metric
- › Store frequently used dies and crimp settings in memory
- › Complete range of dies and accessories available

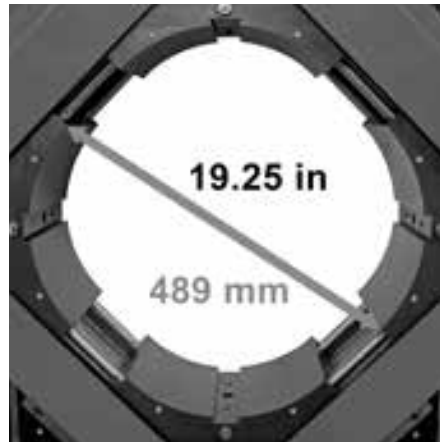

Maximum opening: 19.25 inches/489 mm

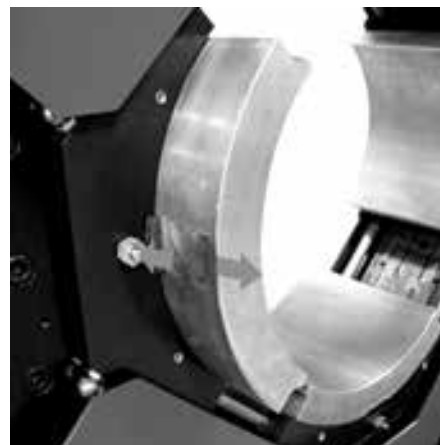

Quick Release Die

Air & Multipurpose

General Purpose
Heavy Duty
Push-on

Chemical Transfer

Cleaning Equipment

Food

Transfer
Washdown

Marine

Material Handling

Abrasives
Bulk Transfer
Cement & Concrete

Mining

Petroleum

Aircraft Fueling
Dispensing
Dock
Transfer

Spray

Steam

Vacuum

LPG Delivery

Water

Discharge
Suction & Discharge
Washdown

Welding

Coupling Systems

Equipment

Appendix

PC1200-P Industrial Crimper

Air & Multipurpose

- General Purpose
- Heavy Duty
- Push-on

Chemical Transfer

Cleaning Equipment

Food
Transfer
Washdown

Marine

Material Handling
Abrasives
Bulk Transfer
Cement & Concrete

Mining

Petroleum
Aircraft Fueling
Dispensing
Dock
Transfer

Spray

Steam

Vacuum

LPG Delivery

Water
Discharge
Suction & Discharge
Washdown

Welding

Coupling Systems

Equipment

Appendix

The patented ACT™ Crimp Controller

- › Can store up to 50 dies and 150 crimp settings
- › Pressure Transducer monitors crimping "effort" eliminating "trial and error" crimping
- › Can track number of crimps and automatically pause for quality check at preset interval
- › Automatically converts inch to mm and mm to inch so that no calculation is ever required

Technical Specifications

Maximum Head Opening w/o Dies	489mm (19.25 in.)
Master Die Inside Diameter	381mm (15 in.)
Maximum Die Opening	152mm
Crimper Size	30 in. wide x 44 in. deep x 74 in. high
Weight with Oil	6185 lbs
Electrical Requirements	230 Volt 3 Phase (Standard) 440-480 Volt 3 Phase (Optional)
Motor	7.5 HP (1 Stage Pump) (Standard) 10 HP (Optional)
Reservoir Capacity	45 US Gal
Oil Type	ISO 46 Hydraulic Oil
Adapter Dies	381-275mm and 275-160mm
Hose Capacity	12 in. Industrial

The 7½ HP pump and electronics are housed in a separate cabinet and are easily accessible for maintenance

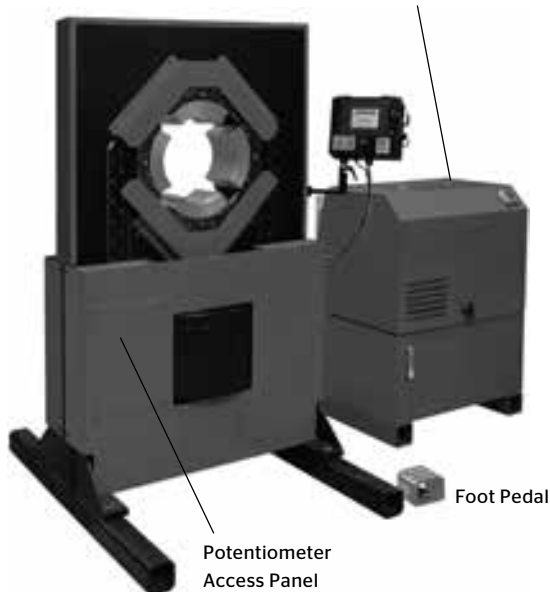

ACT™ Control Module



PCTB1500 / PCTB2500

Description

Continental ContiTech PCTB Series Test Benches provide a safe and efficient method to test hose assemblies for burst or proof testing.

Features

- › Optional electronic model with programmable control including paper printout
- › 1/2" polycarbonate safety window
- › Safety lock to prevent operation when door is not closed
- › Standard garden hose inlet for water supply
- › Factory air inlet supply, 85 psi min. required
- › Powder-coated finish for durability
- › Polyurethane bed liner material coating on interior
- › 7-port outlet manifold for multiple testing
- › Built-in work light for good visibility during testing

Capability

- › PCTB1500 - Test pressure range to 21,500 psi (1500 bar)
- › PCTB2500 - Test pressure range to 37,500 psi (2500 bar)

Power Source

- › Standard 110 VAC, Single Phase Grounded Outlet

Dimensions

- › Interior: 18" H x 35" W x 71" L
- › Includes test bench legs - test area at a convenient working height
- › Full opening allows for hose assemblies to be loaded on a skid

Weight: 750 lbs.

Continental ContiTech Part Numbers

SAP #	Descriptive #
20439763	PCTB-1500 Test Bench
20439764	PCTB-1500 PLC Test Bench
20554088	PCTB-2500 Test Bench
20554089	PCTB-2500 PLC Test Bench



PCTB1500



PCTB2500

Air & Multipurpose

General Purpose
Heavy Duty
Push-on

Chemical Transfer

Cleaning Equipment

Food
Transfer
Washdown

Marine

Material Handling
Abrasives
Bulk Transfer
Cement & Concrete

Mining

Petroleum
Aircraft Fueling
Dispensing
Dock
Transfer

Spray

Steam

Vacuum

LPG Delivery

Water
Discharge
Suction & Discharge
Washdown

Welding

Coupling Systems

Equipment

Appendix

Additional Products

Air & Multipurpose

General Purpose
Heavy Duty
Push-on

Chemical Transfer

Cleaning Equipment

Food

Transfer
Washdown

Marine

Material Handling

Abrasives
Bulk Transfer
Cement & Concrete

Mining

Petroleum

Aircraft Fueling
Dispensing
Dock
Transfer

Spray

Steam

Vacuum

LPG Delivery

Water

Discharge
Suction & Discharge
Washdown

Welding

Coupling Systems

Equipment

Appendix

Additional Non-Stock Specifications

Order Code	Hose Description	Application
Air & Multipurpose		
549-406	Plicord Green EC Air	400 psi wrapped finish Green Air hose, Class B Nitrile tube, Green SBR Class C cover
549-153	Ortac II	200 psi air hose, Class A Nitrile static dissipating tube, Red Class B cover
549-007	Plicord Air Yellow	300 psi air hose, Class C non-conductive tube, Yellow Class C cover
549-260	Plicord Rock Drill	400-500 psi air hose, Class C tube, Blue with Yellow stripe Class C cover
563-599	Ultradraid Air	400 psi air hose, Class C tube, Class C
536-600		non-conductive MSHA cover in Green or Yellow
539-158	Ultradraid Bull Hose	500 psi air hose, Class C tube, Yellow Class C cover
536-589	Ultradraid HD Plus	400 psi air hose, Class A Nitrile tube
536-598		Class A Yellow or Green MSHA cover
539-156	Ultradraid Supreme	1000 psi air hose, Class A Nitrile tube, Class A
539-157		Yellow or Blue high abrasion resistant MSHA cover
Chemical		
549-014	Brown Chem-Acid Discharge	Chemrin tube, versatile chemical discharge hose capable of handling a wide variety of industrial chemicals
546-014	Fabchem ARC	Pliosyn tube, Fabchem with a ARC (Abrasion-Resistant Cover) for a wide variety of industrial chemicals
546-011	Gray Chem-Acid Discharge	Weatherex tube, versatile chemical discharge hose capable of handling a wide variety of industrial chemicals
546-067	Gray Flexwing	Weatherex tube, versatile chemical transfer hose capable of handling a wide variety of industrial chemicals
546-064	Yellow Flexwing	Hysunite tube, versatile chemical transfer hose capable of handling a wide variety of industrial chemicals
546-010	Yellow Chem-Acid Discharge	Hysunite tube, versatile chemical discharge hose capable of handling a wide variety of industrial chemicals
Cleaning Equipment		
539-132	Neptune 2250	Pressure washer service application
539-141	Neptune 3600	Pressure washer service application
Food		
549-147	White Flextra	Lightweight, flexible hose for transferring oily and non-oily edibles under pressure on tank truck or in-plant service
549-150	White Softwall	Discharge transfer of dry or liquid foods having either oily or non-oily bases
539-404	Sani-Wash Plus 1000	Food washdown applications
539-413	Sani-Wash Plus 3000	Food washdown applications
Marine		
586-454	Spiraflex Marine Bilge	PVC hose for drain, vanity and scooper lines
586-447	Spiraflex Marine Livewell	PVC hose for head intake, discharge and pump out service
586-439	Spiraflex Marine Sanitation FDA	PVC hose for potable water transfer
586-451	Spiraflex Marine Vacuum	PVC hose for bilge pumps or holding tank pump out service
586-444	Spiraflex Marine Vacuum FDA	PVC hose for potable water transfer
Material Handling		
549-946	Concrete Vibrator Hose	Reinforced rubber sleeve for concrete vibrator
541-262	Clam Jetting	Softwall hose for underwater jetting and collection of clams

Additional Products

Additional Non-Stock Specifications

Order Code	Hose Description	Application
549-859	Blast Hole Slurry/Dewatering	Hardwall hose for filling blast hole with explosive
Material Handling (continued)		
541-814	Plicord Hyrdrovator Red S&D	Corrugated SBR cover and red natural rubber tube provide good flexibility, durability and outstanding abrasion and tear resistance
549-337	Liquid Mud Hose	Transfer Drilling Mud
549-706	Refractory Hose, 2 Plies	Refractory hose with static dissipating tube
549-863	Gunite, 4 Plies	Sand cement gunning application with static dissipation tube
586-479	Mulchblower	PVC hose for transfer of mulch products
586-477	Barkblower	PVC heavy-duty hose for transfer of wood chips
Cust Serv	Air Seeder	PVC hose for agricultural seeding applications
Mining		
549-229	Plicord Cable Cover Hose	Non-conductive hose for cooling/protection of electrical cables
Petroleum		
532-390	LT Redwing Fuel Oil	Improved flexibility at lower temperatures
541-593	Dock Hose Nitrile FDA	Large bore hose for food products
543-485	Floater Fuel Delivery (Marathon)	Softwall fuel discharge for ship to shore transfer
541-606	Smooth Bore Hot Tar & Asphalt	Hardwall hose with a smooth reinforced line for high-temp applications
541-688	Smooth Bore Molten Sulphur	Hardwall hose with a smooth reinforced liner for high-temp applications
543-142	Black Flextra II 150	Corrugated petroleum-based product transfer hose where aromatic content exceeds 50%
541-579	Plicord Rough Bore Dock	For the transfer of petroleum products between docks and ships
543-802	Plicord LW Northern Petroleum	Lighter weight petroleum-based product transfer hose where aromatic content does not exceed 50%
543-663	Infinity HD LT Petroleum Transfer	Lightweight and flexible properties with improved cold weather capabilities to -40°F /-40°C.
543-509	Plicord Vapor Recovery	Recovering gasoline vapors while unloading tank trucks at service stations or loading tanks at bulk terminals
586-425	Spiraflex Vapor Recovery	PVC hose for vapor recovery
Cust Serv	Oil Rig Supply Hose	Specialized hose lines for use on offshore drilling platforms
Gasoline Dispensing		
532-388	Hardwall Dispensing - Europe	Wire braid gasoline dispensing, meets European Standard EN 1360
532-387	Textile Dispensing - Australian	Textile braid gasoline dispensing, meets Australian Standard AS 2683
532-357	Hardwall Dispensing - Australian	Wire braid gasoline dispensing, meets Australian Standard AS 2683
586-425	Spiraflex Vapor Recovery	PVC hose for vapor recovery
Special Application		
541-219	Fish Suction	Heavy-duty hardwall hose with an abrasive liner
541-320	Furnace coolant hose	Large diameter hose for water cooling in blast furnaces
Cust Serv	Manure line hose	Delivery of manure from holding tanks to field
542-956	Radiator Hose (Standard)	Coolant hose, EPDM tube, EPDM cover, 2 plies
542-957	Radiator Hose (Heavy Duty)	Coolant hose, EPDM tube, EPDM cover, 4 plies
541-843	Plicord Paper Machine Suction Box	Flexible connection on the suction box of paper machines

Air & Multipurpose

General Purpose
Heavy Duty
Push-on

Chemical Transfer

Cleaning Equipment

Food
Transfer
Washdown

Marine

Material Handling
Abrasives
Bulk Transfer
Cement & Concrete

Mining

Petroleum
Aircraft Fueling
Dispensing
Dock
Transfer

Spray

Steam

Vacuum

LPG Delivery

Water
Discharge
Suction & Discharge
Washdown

Welding

Coupling Systems

Equipment

Appendix

Additional Products

Air & Multipurpose

General Purpose
Heavy Duty
Push-on

Chemical Transfer

Cleaning Equipment

Food
Transfer
Washdown

Marine

Material Handling
Abrasives
Bulk Transfer
Cement & Concrete

Mining

Petroleum
Aircraft Fueling
Dispensing
Dock
Transfer

Spray

Steam

Vacuum

LPG Delivery

Water
Discharge
Suction & Discharge
Washdown

Welding

Coupling Systems

Equipment

Additional Non-Stock Specifications

Order Code	Hose Description	Application
541-301	Plicord Leaf Collector	For street cleaning equipment to remove debris
Special Application (continued)		
542-683	Plicord Roof Drain - Nitrile	Handling rainwater drainage from floating tank roof
542-901	Plicord Roof Drain - Viton	Handling rainwater drainage from floating tank roof
Cust Serv	Air Seeder	PVC hose for agricultural seeding applications
586-402	PVC Fish Suction	PVC hose for transfer of fish
549-806	Irrigation pivot joint (boot)	Flexible joint for joining piping
586-476	Fire Engine Suction	PVC hose for water transfer service (clear with black helix)
536-461	Freon Charging GY5	Air-conditioning refrigeration hose (colors: blue/red/yellow)
536-303	Freon Charging All Rubber	Air-conditioning refrigeration hose (colors: blue/red/yellow)
536-486	Divers Hose High Pressure	High pressure diving hose application
536-451	Divers Hose Low Pressure	Low pressure diving hose application
Water		
586-452	Premier	Medium-duty suction and discharge hose for use in agricultural, construction and general industrial service
542-157	Plicord Contractors S&D	Water suction & discharge hose, SBR tube and cover
542-547	Jetting & Utility	High pressure water service
542-445	Potable Water 150 psi	Potable water, white natural FDA tube
542-162	Plicord Water Discharge-300 psi	General purpose water discharge hose for heavier duty applications
542-322	Plicord Water & Suction-300 psi	General purpose water S&D hose for heavier duty applications
537-512	Spiraflex 3000 (black)	PVC Lay flat for wheel line irrigation service
Military		
569-536	ZZ H 500C	General shop service pneumatic hose
569-567	ZZ H 601E	General water and potable water discharge service
Cust Serv	ZZ H 601E	General water and potable water discharge service
543-811	Mil PRF 370H Type A	Fuel transfer standard collapsible
543-760	Mil PRF 370H Type B	Fuel transfer standard noncollapsible
543-552	Mil DTL-6615 Type I	Fuel transfer hose with low-temperature capability, with electrical bond
543-553	Mil DTL-6615 Type II	Fuel transfer hose with low-temperature capability, without electrical bond
Cust Serv	ZZ H 561K	Water suction and discharge hose
543-766	Mil H 2224OF Type A	Lightweight fuel hose for alongside service
543-769	Mil H 2224OF Type C	Lightweight fuel/water discharge hose for alongside service
Cust Serv	Mil PRF 11588G	Fuel discharge hose style ST only
Cust Serv	Mil H 82127 Type A	Fuel discharge hose for aviation gasoline, diesel, and automotive fuels
549-749	Mil H 24136/4	Sound attenuation hose
547-855	Mil H 8788C	For use in hydraulic systems
536-341	Mil H 24580SH	Onboard ship firefighting hose

Chemical Charts

Continental ContiTech Chemical Resistance Chart Ratings and Definitions

The Continental ContiTech Chemical Resistance Chart is to be used as a guide only.

- A** The chemical is expected to have minor or no effect on the product. Product may be used for continuous service. Changes in working conditions, such as concentration of the chemical or temperature, may affect product performance and cause degradation of the product.
- B** The product may be used for continuous or intermittent service, however the product properties will be affected by the exposure to the chemical. Changes in working conditions, such as concentration of the chemical or temperature, may affect product performance and cause degradation of the product.
- X** The product should not be used with this chemical.
- I** Insufficient or no data available for this chemical. Further testing is recommended to determine compatibility of the chemical with the product.

Caution: Unless otherwise specified, the ratings applied to tube stocks are based on fully concentrated or saturated solutions at 100°F (38°C) under normal service conditions.

Note: Hose ratings are for the effect on the polymer only. The degree of resistance of a rubber compound to a specific chemical depends on many variables such as temperature, concentration, length of exposure, stability of chemical, etc. For a specific compound, many grades of polymers are available which can alter the compound's chemical resistance.

WHEN IN DOUBT, before using a specific product, contact your local Continental ContiTech Sales Representative for assistance if unusual service conditions or high temperatures are present in the product application.

This chemical resistance chart supersedes all previously published information regarding Continental ContiTech chemical hose resistance ratings.

Air & Multipurpose
General Purpose
Heavy Duty
Push-on

Chemical Transfer

Cleaning Equipment

Food
Transfer
Washdown

Marine

Material Handling
Abrasives
Bulk Transfer
Cement & Concrete

Mining

Petroleum
Aircraft Fueling
Dispensing
Dock
Transfer

Spray

Steam

Vacuum

LPG Delivery

Water
Discharge
Suction & Discharge
Washdown

Welding

Coupling Systems

Equipment

Appendix

Chemical Charts

	Common Name & Description	Continental ContiTech Trade Name	Continental ContiTech Product Examples with Polymer in the Tube
Air & Multipurpose General Purpose Heavy Duty Push-on	UHMWPE (Ultra High Molecular Weight Polyethylene)	Pliosyn	Fabchem
	Butyl (Isobutylene and Isoprene)	Weatherex	Gray Flexwing
	Hypalon (Chlorosulfonated Polyethylene)	Hysunite	Yellow Flexwing
Chemical Transfer	NR - Natural Rubber (Isoprene, natural)	Pureten	Tan Flexwing
	Viton	Flosyn	Orange Flexwing
Cleaning Equipment	Nitrile		Flexwing Petroleum
	CPE (Chlorinated Polyethylene)	Chemrin	Brown Flexwing, ExtremeFlex Brown
Food Transfer Washdown	EPDM (Ethylene Propylene Diene)	EPDM	Purple Flexwing, ExtremeFlex Purple
	EPDM (Heat Resistant)	Pyrosyn	Flexsteel 250 Steam, Whitewater
Marine	Cross-Link Polyethylene (XLPE)	Speclar	Blue Flexwing, Green XLPE
	Alphasyn (Modified Cross-Link Polyethylene)	Alphasyn	Viper
Material Handling Abrasives Bulk Transfer Cement & Concrete	Teflon		Hi-Per Insta-Lock
	316 Stainless Steel		Insta-Lock
Mining	Aluminum		Insta-Lock
	Brass		
Petroleum Aircraft Fueling Dispensing Dock Transfer			
Spray			
Steam			
Vacuum			
LPG Delivery			
Water Discharge Suction & Discharge Washdown			
Welding			
Coupling Systems			
Equipment			

Caution: This chart and the following chemical resistance charts are intended to reflect the various tube compounds as they pertain to Continental ContiTech petroleum and chemical hose. Always use a Continental ContiTech petroleum or chemical hose when the hose is to be used for conveyance of petroleum or chemicals. Consult the following pages for chemical compatability of the various tube stocks.

Hypalon® is a registered trademark of DuPont Dow Elastomers L.L.C.

Viton® is a registered trademark of DuPont Dow Elastomers L.L.C.

Teflon® is a registered trademark of E.I. du Pont de Nemours and Company.

Chemical Charts

Rating Scale

A = May be used for Continuous Service **B** = May be used for Intermittent Service
I = Insufficient data, contact Customer Service **X** = Do not use

Gasket

T = Teflon® **N** = Neoprene **V** = Viton®
S = Silicone **B** = Nitrile

Continental ContiTech Chemical Hose / Hose Tube Polymer													Insta-Lock™ Fitting/Metal			
Temp. (°F)*	Fabchem UHMWPE	Gray Flexwing Butyl	Yellow Flexwing Hypalon	Tan Flexwing NR	Orange Flexwing Viton	Flexwing Petroleum Nitrile	Brown Flexwing & ExtremeFlex Brown CPE	Purple Flexwing & ExtremeFlex Purple EPDM	Blue Flexwing & Green XLPE	Chem One & Viper Alphasyn	HIPER Teflon	316 SS	Aluminum	Brass	Gasket	
A																
Acetaldehyde	100	B	B	X	X	X	X	I	A	A	A	A	A	B	X	TS
Acetic Acid, Conc.	100	A	A	X	B	X	X	A	A	A	A	A	B	X	T	
Acetic Acid, Dilute 10	150	B	A	X	A	X	X	A	A	A	A	A	I	X	TVN	
Acetic Acid, Glacial	100	A	B	X	X	X	X	A	A	A	A	A	B	X	TS	
Acetic Aldehyde	100	A	B	X	X	X	X	I	A	A	A	A	B	X	T	
Acetic Anhydride	100	B	A	B	X	X	X	A	A	A	A	A	B	X	TS	
Acetic Ester	100	B	B	X	X	X	X	B	A	A	A	A	A	A	TV	
Acetic Ether	100	B	B	X	X	X	X	B	A	A	A	A	A	A	T	
Acetic Oxide	100	B	A	B	X	X	X	A	A	A	A	A	B	X	T	
Acetone	100	A	A	X	B	X	X	A	A	A	A	A	A	I	T	
Acetone Cyanohydrin	100	B	A	X	X	X	X	A	A	A	A	I	I	I	TS	
Acetyl Acetone	100	B	B	X	X	X	X	B	I	A	A	I	B	I	T	
Acetyl Chloride	100	B	X	X	X	B	X	A	B	B	A	B	X	A	TV	
Acetyl Oxide	100	B	A	B	X	X	X	A	A	A	A	A	B	X	T	
Acetylene (dry)	100	A	A	A	A	A	A	A	A	A	X	A	I	I	TVBNS	
Acetylene Dichloride	100	B	X	X	X	A	X	I	I	A	X	A	I	A	X	TV
Acetylene Tetrachloride	100	B	X	X	X	A	X	I	I	A	I	A	A	X	X	TV
Acrolein	100	B	A	B	B	A	B	I	I	A	A	A	I	I	I	TV
Acrylic Acid	100	B	X	X	X	A	X	X	X	A	A	A	I	I	I	TV
Acrylonitrile	100	B	X	X	X	X	X	A	X	B	A	A	A	X	I	T
Alk-Tri	100	I	X	X	X	A	X	I	I	A	I	A	A	I	I	TV
Allyl Alcohol	100	A	A	A	A	B	A	A	A	A	A	A	I	A	TBN	
Allyl Bromide	100	B	X	X	X	B	X	B	I	B	I	A	I	I	T	
Allyl Chloride	100	B	X	X	X	B	X	B	X	B	I	A	A	X	X	TS
Alum	150	A	A	A	A	A	A	A	A	A	A	A	I	X	TVBNS	
Aluminum Acetate	100	A	A	A	X	X	X	A	A	A	A	A	I	X	T	
Aluminum Chloride	150	A	A	A	A	A	A	A	A	A	A	A	I	X	TVB	
Aluminum Formate	100	A	B	X	X	X	X	I	I	A	A	A	I	I	T	
Aluminum Hydroxide	150	A	A	B	A	X	B	A	A	A	A	A	I	X	TS	
Aluminum Sulfate	150	A	A	A	A	A	A	A	A	A	A	A	X	X	TVBNS	
Aminoethanol	100	A	A	B	B	I	B	A	I	A	A	A	B	I	TBN	
Aminoethylethanolamine	100	A	A	B	B	I	B	A	A	A	A	A	I	I	T	
Ammonia	---	No Hose Recommended For This Application														
Ammonia Cupric Sulfate	150	A	A	A	X	A	A	A	A	A	A	A	I	I	I	TVB
Ammonium Chloride	150	A	A	A	A	A	A	A	A	A	A	A	X	X	TVBN	
Ammonium Hydroxide	150	A	A	B	A	X	X	A	X	A	A	A	X	I	TNS	
Ammonium Nitrate	150	Special Hose Required														
Ammonium Phosphate	150	A	A	A	A	A	A	A	A	A	A	A	A	X	X	TVBNS
Ammonium Sulfate	150	A	A	A	A	A	X	A	A	A	A	A	X	X	TVNS	

* Fahrenheit to Celsius conversion key: 100°F (38°C), 125°F (52°C), 150°F (66°C), 275°F (135°C) and 500°F (260°C).

This chemical chart is offered as a guide only. There are many variables to be considered with each application. Ratings are for tube polymer only! For explanation of ratings see the initial page of these Chemical Charts in Appendix B. Contact Customer Service for chemicals or polymers not listed at 800-235-4632.

Chemical Charts

Rating Scale

A = May be used for Continuous Service

B = May be used for Intermittent Service

I = Insufficient data, contact Customer Service

X = Do not use

Gasket

T = Teflon®

N = Neoprene

V = Viton®

S = Silicone

B = Nitrile

Continental ContiTech Chemical Hose / Hose Tube Polymer													Insta-Lock™ Fitting/Metal			
Temp. (°F)*	Fabchem UHMWPE	Gray Flexwing Butyl	Yellow Flexwing Hypalon	Tan Flexwing NR	Orange Flexwing Viton	Flexwing Petroleum Nitrile	Brown Flexwing & ExtremeFlex Brown CPE	Purple Flexwing & ExtremeFlex Purple EPDM	Blue Flexwing & Green XLPE	Chem One & Viper Alphasyn	HIPER Teflon	316 SS	Aluminum	Brass	Gasket	
A																
Ammonium Sulfide	150	A	A	A	A	A	X	A	A	A	A	A	X	X	TVN	
Ammonium Sulfite	150	A	A	A	A	A	A	A	A	A	A	A	X	I	TVBN	
Ammonium Thiosulfate	100	A	A	A	A	A	A	A	A	A	A	A	B	X	TVBN	
Amyl Acetate	100	A	A	B	X	X	X	X	B	A	A	A	A	I	T	
Amyl Alcohol	100	A	A	A	A	B	A	A	A	A	A	A	I	A	TBNS	
Amyl Chloride	100	A	X	X	X	A	X	X	X	A	B	A	A	X	I	TV
Amyl Oleate	100	A	X	X	X	I	B	I	I	A	I	A	I	I	I	T
Amyl Phenol	100	A	X	X	X	A	X	I	I	A	I	A	I	I	I	TV
Amyl Phthalate	100	A	A	X	X	X	X	I	I	A	I	A	I	I	I	T
Amylamine	100	A	B	X	X	X	X	B	X	A	I	A	I	I	I	T
Anethole	100	X	X	X	X	B	X	X	I	X	I	A	I	I	I	T
Anhydrous Ammonia	---	No Hose Recommended For This Application														
Aniline	100	A	A	X	X	A	X	B	A	A	A	A	B	X	TV	
Animal Grease	100	A	X	X	X	A	A	B	X	A	A	A	A	I	TVB	
Animal Oils	100	A	B	X	X	A	A	A	X	A	B	A	A	A	TVB	
Antimony Pentachloride	100	A	X	X	X	I	X	I	X	B	B	A	I	I	I	T
Aqua Ammonia	150	A	A	B	A	A	B	B	B	A	A	A	A	X	I	TV
Aromatic Spirits	100	A	X	X	X	A	X	I	X	A	I	A	A	I	I	TV
Aromatic Tar	100	A	X	X	X	A	X	B	X	A	I	A	I	I	I	TV
Arquads	100	A	A	A	A	A	A	A	A	A	A	A	I	I	I	TVB
Arsenic Acid	100	A	A	A	A	I	X	A	A	A	A	A	A	X	X	TVS
Arsenic Chloride	100	I	X	X	X	X	X	X	X	X	X	A	I	I	I	TN
Arsenic Trichloride	100	I	X	X	X	X	X	X	X	X	X	A	X	I	I	TN
Asphalt	500	Special Hose Required										A	I	I	TVN	
ASTM #1 Oil	100	A	X	B	X	A	A	A	X	A	A	A	A	A	I	TVBNS
ASTM #2 Oil	100	A	X	X	X	A	A	A	X	A	A	A	A	A	A	TVB
ASTM #3 Oil	100	A	X	X	X	A	A	A	X	A	A	A	A	A	A	TVB
B																
Barium Carbonate	150	A	A	A	A	A	A	A	A	A	A	A	A	X	I	TVBN
Barium Chloride	150	A	A	A	A	A	A	A	A	A	A	A	A	X	I	TVBN
Barium Hydroxide	150	A	A	A	A	B	A	A	A	A	A	A	A	X	X	TBNS
Barium Sulfate	150	A	A	A	A	A	A	A	A	A	A	A	B	A	X	TVBS
Barium Sulfide	150	A	A	A	A	A	A	A	A	A	A	A	A	X	X	TVBS
Benzal Chloride	100	A	B	I	I	I	X	X	I	A	I	A	B	X	I	T
Benzaldehyde	100	A	B	X	X	X	X	X	B	A	B	A	A	B	I	T
Benzene (Benzol)	100	A	X	X	X	A	X	X	X	B	B	A	A	A	A	TV
Benzine (Ligroin)	100	A	X	X	X	A	A	I	X	A	B	A	A	A	I	TVB
Benzine Solvent (Ligroin)	100	A	X	X	X	A	A	I	X	A	I	A	A	A	I	TVBS

* Fahrenheit to Celsius conversion key: 100°F (38°C), 125°F (52°C), 150°F (66°C), 275°F (135°C) and 500°F (260°C).

This chemical chart is offered as a guide only. There are many variables to be considered with each application. Ratings are for tube polymer only! For explanation of ratings see the initial page of these Chemical Charts in Appendix B. Contact Customer Service for chemicals or polymers not listed at 800-235-4632.

Chemical Charts

Rating Scale

A = May be used for Continuous Service
I = Insufficient data, contact Customer Service
B = May be used for Intermittent Service
X = Do not use

Gasket

T = Teflon®
S = Silicone
N = Neoprene
B = Nitrile
V = Viton®

Continental ContiTech Chemical Hose / Hose Tube Polymer													Insta-Lock™ Fitting/Metal			
Temp. (°F)*	Fabchem UHMWPE	Gray Flexwing Butyl	Yellow Flexwing Hypalon	Tan Flexwing NR	Orange Flexwing Viton	Flexwing Petroleum Nitrile	Brown Flexwing & ExtremeFlex Brown CPE	Purple Flexwing & ExtremeFlex Purple EPDM	Blue Flexwing & Green XLPE	Chem One & Viper Alphasyn	HIPER Teflon	316 SS	Aluminum	Brass	Gasket	
B																
Benzoic Acid	100	A	B	B	X	I	I	A	B	A	A	A	B	B	X	TVN
Benzoic Aldehyde	100	A	B	X	X	X	X	X	B	A	I	A	A	I	B	T
Benzotrichloride	100	X	I	I	I	I	X	X	X	X	A	I	I	I	T	
Benzoyl Chloride	100	X	I	I	I	I	X	X	X	B	X	A	B	I	T	
Benzyl Acetate	100	A	A	B	X	X	X	B	I	A	B	A	B	I	T	
Benzyl Alcohol	100	A	A	X	X	A	X	A	X	A	A	A	A	B	I	TVS
Benzyl Chloride	100	A	X	X	X	A	X	X	X	A	I	A	A	X	X	T V
Bichromate of Soda	150	A	A	X	I	I	I	I	I	A	A	A	I	I	I	T
Black Sulfate Liquor	150	A	X	B	B	B	B	A	B	A	A	A	A	X	X	TVBN
Black Sulfate Liquor	275	X	X	X	X	X	X	A	X	X	X	A	A	X	X	T
Bleach	100	X	B	X	X	B	X	I	A	X	B	A	X	X	X	T V
Brine	150	A	A	A	A	A	A	A	A	A	A	A	A	X	I	TVBNS
Bromine	100	X	X	X	X	B	X	I	X	X	X	A	X	X	X	T V
Bromo Benzene	100	B	X	X	X	B	X	X	X	X	X	A	I	I	I	T V
Bromo Toluene	100	X	X	X	X	B	X	X	X	X	X	A	I	I	I	T
Bromochloromethane	100	X	B	X	X	B	X	X	I	X	A	A	A	X	X	T
Bunker C.	100	B	X	X	X	A	A	I	X	A	B	A	A	I	I	TVB
Bunker Oil	100	B	X	X	X	A	A	I	X	X	B	A	A	I	I	TVB
Butanol	100	A	A	A	A	B	A	A	A	A	A	A	A	I	I	TBN
Butyl (Normal) Alcohol	100	A	A	A	A	B	A	A	A	A	A	A	A	I	I	TBN
Butyl (Secondary) Alcohol	100	A	A	A	A	B	A	A	A	A	A	A	A	I	I	TBN
Butyl Acetate	100	A	A	B	X	X	X	B	B	A	B	A	A	B	I	T
Butyl Acetoacetate	100	A	X	X	X	X	X	X	I	A	B	A	I	I	I	T
Butyl Acrylate	100	B	X	X	X	X	X	B	X	B	B	A	I	I	I	T
Butyl Alcohol	100	A	A	A	A	B	A	A	A	A	A	A	A	I	I	TBN
Butyl Aldehyde	100	A	B	X	X	X	X	B	X	A	B	A	X	A	X	T
Butyl Amine	100	A	B	X	X	X	X	B	X	A	B	A	A	A	I	T
Butyl Benzene	100	A	X	X	X	A	X	X	X	A	B	A	I	I	I	T V
Butyl Benzl Phthalate	100	A	A	X	X	X	X	I	I	A	I	A	I	I	I	T
Butyl Bromide	100	B	X	X	X	B	X	X	X	B	B	A	I	I	I	T
Butyl Butyrate	100	B	X	X	X	X	X	X	I	B	I	A	I	I	I	T V
Butyl Carbitol	100	A	A	A	X	I	X	A	B	A	A	A	I	I	I	T
Butyl Cellosolve	100	A	A	A	X	X	X	A	A	X	A	A	A	A	X	T
Butyl Chloride	100	B	X	X	X	A	X	X	I	B	I	A	B	I	I	T V
Butyl Ether	100	A	X	B	X	X	B	A	X	A	A	A	A	I	I	T
Butyl Ethyl Acetaldehyde	100	A	B	X	X	X	X	I	I	A	B	A	I	I	I	T
Butyl Ethyl Ether	100	A	X	B	X	I	B	I	X	A	A	A	I	I	I	T

* Fahrenheit to Celsius conversion key: 100°F (38°C), 125°F (52°C), 150°F (66°C), 275°F (135°C) and 500°F (260°C).

This chemical chart is offered as a guide only. There are many variables to be considered with each application. Ratings are for tube polymer only! For explanation of ratings see the initial page of these Chemical Charts in Appendix B. Contact Customer Service for chemicals or polymers not listed at 800-235-4632.

Chemical Charts

Rating Scale

A = May be used for Continuous Service

B = May be used for Intermittent Service

I = Insufficient data, contact Customer Service

X = Do not use

Gasket

T = Teflon®

N = Neoprene

V = Viton®

S = Silicone

B = Nitrile

	Temp. (°F)*	Continental ContiTech Chemical Hose / Hose Tube Polymer											Insta-Lock™ Fitting/Metal				
		Fabchem UHMWPE	Gray Flexwing Butyl	Yellow Flexwing Hypalon	Tan Flexwing NR	Orange Flexwing Viton	Flexwing Petroleum Nitrile	Brown Flexwing & ExtremeFlex Brown CPE	Purple Flexwing & ExtremeFlex Purple EPDM	Blue Flexwing & Green XLPE	Chem One & Viper Alphasyn	HIPER Teflon	316 SS	Aluminum	Brass	Gasket	
B																	
Butyl Phthalate	100	A	A	X	X	X	X	I	I	A	A	A	A	A	A	I	T
Butyl Stearate	100	A	X	X	X	I	A	B	X	A	B	A	A	A	A	A	TBS
Butylate	100	A	I	I	I	I	I	I	A	I	I	I	I	I	I	I	I
Butyraldehyde	100	A	B	X	X	X	X	B	X	A	B	A	X	A	X	X	T
Butyric Acid	100	A	X	B	X	I	X	A	B	A	A	A	A	B	I	T	
Butyric Anhydride	100	A	X	B	X	I	X	I	I	A	I	A	I	I	I	T	
C																	
Cadmium Acetate	100	A	A	A	X	X	X	A	I	A	A	A	I	I	I	T	
Calcium Acetate	100	A	A	A	X	X	X	A	A	A	A	A	A	I	I	TB	
Calcium Aluminate	100	A	A	A	A	A	A	A	A	A	A	A	I	I	I	TVB	
Calcium Bichromate	150	X	A	X	I	I	I	I	I	X	I	A	I	I	I	T	
Calcium Bisulfate	150	A	A	A	A	A	A	A	A	A	A	A	A	X	X	TVBN	
Calcium Bisulfite	150	A	A	A	A	A	A	A	A	I	A	A	A	X	X	TVBNS	
Calcium Carbonate	150	A	A	A	A	A	A	A	A	A	A	A	A	I	X	TVBNS	
Calcium Chloride	150	A	A	A	A	A	A	A	A	A	A	A	B	X	X	TVBNS	
Calcium Hydroxide (Caustic Lime)	100	A	A	B	A	X	B	A	A	A	A	A	A	X	X	TNS	
Calcium Hypochlorite	100	B	B	X	X	B	X	A	B	X	A	A	A	X	X	T V	
Calcium Nitrate	150	A	A	A	A	A	A	A	A	A	A	A	B	X	X	TVBN	
Calcium Silicate	150	A	A	A	A	A	A	A	A	A	A	A	I	A	I	TVBN	
Calcium Sulfate	150	A	A	A	A	A	A	A	A	A	A	A	A	I	I	TVBS	
Calcium Sulfhydrate	100	A	A	A	A	A	A	A	A	A	A	A	I	I	I	TVB	
Calcium Sulfide	150	A	A	A	A	A	A	A	A	A	A	A	A	X	X	TVBN	
Calcium Sulfite	150	A	A	A	X	A	A	A	A	A	A	A	B	B	X	TVBNS	
Caprylic Acid	100	A	X	B	X	I	X	A	I	A	A	A	B	I	X	T	
Carbitol	100	A	A	A	X	I	X	A	A	A	A	A	B	A	X	T	
Carbitol Acetate	100	A	B	B	X	I	X	I	I	A	A	A	I	I	I	T	
Carbolic Acid, Phenol	100	A	A	X	X	A	X	A	X	A	B	A	A	B	A	T V	
Carbon Dioxide	100	A	A	A	A	A	A	A	A	A	A	A	A	B	I	TVBNS	
Carbon Disulfide	---	No Hose Recommended For This Application															
Carbon Tetrachloride	100	B	X	X	X	A	X	X	X	A	B	A	A	I	I	T V	
Carbonic Acid	100	A	A	A	A	A	A	A	A	A	A	A	A	B	B	TVBS	
Casinghead Gasoline	100	B	X	X	X	A	A	B	X	B	B	A	I	I	I	TVB	
Caster Oil (Castor Oil)	100	A	A	A	X	A	A	A	A	A	A	A	A	A	I	TVBS	
Caustic Potash	150	A	A	B	A	X	B	A	B	A	A	A	A	X	X	T	
Caustic Soda	150	A	A	B	A	X	B	A	A	A	A	A	A	X	X	TNS	
Cellosize	100	A	A	X	X	I	X	I	I	A	A	A	I	I	I	T	
Cellosolve	100	A	A	A	X	X	X	I	A	A	A	A	A	A	X	T	
Cellosolve Acetate	100	A	B	B	X	X	X	X	B	A	A	A	A	I	X	T	

* Fahrenheit to Celsius conversion key: 100°F (38°C), 125°F (52°C), 150°F (66°C) and 500°F (260°C).

This chemical chart is offered as a guide only. There are many variables to be considered with each application. Ratings are for tube polymer only! For explanation of ratings see the initial page of these Chemical Charts in Appendix B. Contact Customer Service for chemicals or polymers not listed at 800-235-4632.

Chemical Charts

Rating Scale

A = May be used for Continuous Service **B** = May be used for Intermittent Service
I = Insufficient data, contact Customer Service **X** = Do not use

Gasket

T = Teflon® **N** = Neoprene **V** = Viton®
S = Silicone **B** = Nitrile

Continental ContiTech Chemical Hose / Hose Tube Polymer														Insta-Lock™ Fitting/Metal			
Temp. (°F)*	Fabchem UHMWPE	Gray Flexwing Butyl	Yellow Flexwing Hypalon	Tan Flexwing NR	Orange Flexwing Viton	Flexwing Petroleum Nitrile	Brown Flexwing & ExtremeFlex Brown CPE	Purple Flexwing & ExtremeFlex Purple EPDM	Blue Flexwing & Green XLPE	Chem One & Viper Alphasyn	HIPER Teflon	316 SS	Aluminum	Brass	Gasket		
C																	
Chloracetic Acid	100	A	X	X	B	X	X	A	X	A	A	A	A	X	X	T	
Chlorinated Solvents	100	B	X	X	X	A	X	B	X	A	I	A	B	X	A	T V	
Chlorine (Dry) (Gas)	---	No Hose Recommended For This Application															
Chlorine (Wet)	100	X	X	X	X	B	X	X	X	X	X	A	X	X	X	T V	
Chloroacetone	100	A	I	X	X	X	X	X	X	A	I	A	A	X	X	T	
Chlorobenzene	100	B	X	X	X	A	X	X	X	A	B	A	A	B	I	T V	
Chlorobenzol	100	A	X	X	X	A	X	I	X	A	B	A	A	B	I	T V	
Chlorobutane	100	X	X	X	X	A	X	X	I	X	I	A	I	I	I	T V	
Chloroethylbenzene	100	A	X	X	X	A	X	I	X	A	I	A	I	I	I	T V	
Chloroform	100	B	X	X	X	B	X	X	X	X	B	A	A	B	I	T V	
Chloropentane	100	A	X	X	X	A	X	X	X	A	I	A	A	X	I	T V	
Chlorophenol	100	A	X	X	X	B	X	X	X	X	B	A	I	I	I	T V	
Chloropropanone	100	A	I	X	X	X	X	X	X	A	I	A	I	I	I	T	
Chlorosulfonic Acid	100	X	X	X	X	X	X	I	X	X	X	A	B	X	X	T	
Chlorothene	100	X	X	X	X	A	X	I	X	A	I	A	A	I	I	T V	
Chlorotoluene	100	X	X	X	X	A	X	X	X	X	I	A	A	I	I	T V	
Chlorpyrifos	100	I	I	I	I	I	I	I	X	I	I	I	I	I	I	I	
Chromic Acid 25%	100	B	X	B	X	I	X	A	X	X	B	A	B	X	X	T V	
Coal Oil	100	A	X	X	X	A	A	A	X	A	A	A	A	X	A	TVB	
Coal Tar	100	A	X	X	X	A	X	B	X	A	A	A	A	I	I	TVS	
Coal Tar Naptha	100	A	X	X	X	A	X	B	X	A	A	A	A	A	I	T V	
Copper Chloride	100	A	A	A	X	A	A	A	A	A	A	A	X	X	X	TVBNS	
Copper Hydrate	100	A	A	B	X	X	B	I	I	A	A	A	I	I	I	T B	
Copper Hydroxide	100	A	A	B	X	X	B	I	I	A	A	A	I	I	I	T B	
Copper Nitrate	100	A	A	A	X	A	A	A	A	A	A	A	A	X	X	TVBNS	
Copper Nitrite	100	A	A	A	X	A	A	A	A	A	A	A	I	I	I	TVB	
Copper Sulfate	100	A	A	A	X	A	A	A	A	A	A	A	A	X	X	TVBNS	
Copper Sulfide	100	A	A	A	X	A	A	A	A	A	A	A	I	I	I	TVB	
Creosols	100	A	A	X	X	A	X	A	X	A	B	A	A	I	X	T V	
Creosote	100	A	X	X	X	A	B	I	X	A	B	A	A	I	I	T V	
Cresylic Acid	100	A	A	X	X	I	X	X	X	A	I	A	A	B	X	T V	
Crotonaldehyde	100	A	A	X	X	X	X	A	I	A	A	A	I	I	I	T	
Crude Oil	100	A	X	X	X	A	A	B	X	A	B	A	A	A	I	TVB	
Cumene	100	A	X	X	X	A	X	X	X	A	B	A	I	I	I	T V	
Cupric Carbonate	100	A	A	A	X	A	A	A	A	A	A	A	I	I	I	TVBN	
Cupric Chloride	100	A	A	A	X	A	A	A	A	A	A	A	B	X	I	TVBNS	
Cupric Nitrate	100	A	A	A	X	A	A	A	A	A	A	A	B	I	I	TVBN	
Cupric Nitrite	100	A	A	A	X	A	A	A	A	A	A	A	I	I	I	TVB	
Cupric Sulfate	100	A	A	A	X	A	A	A	A	A	A	A	I	I	I	TVBNS	
Cyclohexane	100	A	X	X	X	A	B	A	X	A	B	A	A	B	X	T V	

* Fahrenheit to Celsius conversion key: 100°F (38°C), 125°F (52°C), 150°F (66°C), 275°F (135°C) and 500°F (260°C).

This chemical chart is offered as a guide only. There are many variables to be considered with each application. Ratings are for tube polymer only! For explanation of ratings see the initial page of these Chemical Charts in Appendix B. Contact Customer Service for chemicals or polymers not listed at 800-235-4632.

Chemical Charts

Rating Scale

A = May be used for Continuous Service
I = Insufficient data, contact Customer Service
B = May be used for Intermittent Service
X = Do not use

Gasket

T = Teflon®
S = Silicone
N = Neoprene
B = Nitrile
V = Viton®

	Continental ContiTech Chemical Hose / Hose Tube Polymer													Insta-Lock™ Fitting/Metal			
	Temp. (°F)*	Fabchem UHMWPE	Gray Flexwing Butyl	Yellow Flexwing Hypalon	Tan Flexwing NR	Orange Flexwing Viton	Flexwing Petroleum Nitrile	Brown Flexwing & ExtremeFlex Brown CPE	Purple Flexwing & ExtremeFlex Purple EPDM	Blue Flexwing & Green XLPE	Chem One & Viper Alphasyn	HIPER Teflon	316 SS	Aluminum	Brass	Gasket	
C																	
Cyclohexanol	100	A	X	X	X	B	B	A	X	A	B	A	A	X	X	TVB	
Cyclohexanone	100	A	X	X	X	X	X	X	X	A	B	A	A	I	I	T	
Cyclopentane	100	A	X	X	X	A	B	B	X	A	B	A	I	I	I	TVN	
Cyclopentane, methyl	100	A	X	X	X	A	B	I	X	A	B	A	I	I	I	TV	
Cyclopentanol	100	A	X	X	X	B	B	A	X	A	A	A	I	I	I	TVB	
Cyclopentanone	100	A	X	X	X	X	X	X	X	A	B	A	I	I	I	T	
D																	
D.D.T. in Kerosene	100	A	X	X	X	A	A	A	X	A	B	A	I	I	A	TVB	
D.M.P.	100	X	X	X	X	X	X	X	X	X	A	A	A	I	I	TV	
Decalin	100	X	X	X	X	A	X	X	X	A	X	A	I	I	I	TV	
Decanol	100	A	A	A	X	B	A	A	A	A	A	A	I	I	I	TB	
Decyl Alcohol	100	A	A	A	X	B	A	A	A	A	A	A	I	I	I	TB	
Decyl Aldehyde	100	A	X	X	X	X	X	I	I	A	B	A	I	I	I	T	
Decyl Butyl Phthalate	100	A	A	X	X	X	X	I	I	A	I	A	I	I	I	T	
Denatured Alcohol	100	A	A	A	A	B	A	A	A	A	A	A	A	B	A	TB	
Diacetone Alcohol	100	A	A	B	B	X	X	A	X	A	A	A	A	I	I	T	
Diamyl Phenol	100	A	X	X	X	A	X	A	X	A	I	A	I	I	I	TV	
Diamylamine	100	A	A	X	B	I	B	A	I	A	B	A	I	I	I	TB	
Diamylene	100	A	X	X	X	A	X	B	X	A	B	A	I	I	I	TV	
Dibenzyl Ether	100	A	B	X	X	I	X	X	X	A	B	A	A	A	X	T	
Dibromobenzene	100	B	X	X	X	A	X	I	X	A	I	A	I	I	I	TV	
Dibutyl Amine	100	A	X	X	B	X	B	A	X	A	A	A	I	I	I	T	
Dibutyl Ether	100	A	X	B	X	X	X	A	X	A	A	A	A	A	X	T	
Dibutyl Phthalate	100	A	A	X	X	X	X	X	A	A	A	A	A	A	I	TV	
Dibutyl Sebacate	100	A	A	X	X	X	X	B	X	A	I	A	I	I	I	TVS	
Dicalcium Phosphate	100	A	A	A	A	A	A	A	A	A	A	A	I	I	I	TVB	
Dicamba	100	A	I	I	I	I	I	I	A	A	I	A	I	I	I	T	
Dichloroacetic Acid	100	A	X	X	B	X	X	B	I	A	I	A	I	I	I	T	
Dichlorobenzene	100	A	X	X	X	A	X	X	X	A	B	A	A	B	I	TV	
Dichlorobutane	100	A	X	X	X	A	X	X	X	A	I	A	I	I	I	TV	
Dichlorodifluoromethane	100	I	X	X	X	B	B	I	X	I	X	A	I	I	I	TVB	
Dichloroethane	100	A	X	X	X	A	X	X	X	A	A	A	I	A	I	TV	
Dichloroethyl Ether	100	A	X	X	X	I	X	B	X	A	B	A	I	I	I	T	
Dichloroethylene	100	X	X	X	X	A	X	I	I	X	X	A	I	A	X	TV	
Dichlorohexane	100	A	X	X	X	A	X	X	X	A	A	A	I	I	I	TV	
Dichloropentane	100	A	X	X	X	A	X	X	X	A	B	A	I	I	I	TV	
Dichloropropane	100	A	X	X	X	A	X	X	X	B	I	A	A	X	I	TV	
Diesel Oil	150	A	X	X	X	A	A	A	X	A	B	A	A	A	I	TVB	
Diethanol Amine	100	A	A	X	B	I	B	A	I	A	A	A	A	I	I	T	
Diethyl Benzene	100	A	X	X	X	A	X	X	X	A	B	A	I	I	I	TV	

* Fahrenheit to Celsius conversion key: 100°F (38°C), 125°F (52°C), 150°F (66°C), 275°F (135°C) and 500°F (260°C).

This chemical chart is offered as a guide only. There are many variables to be considered with each application. Ratings are for tube polymer only! For explanation of ratings see the initial page of these Chemical Charts in Appendix B. Contact Customer Service for chemicals or polymers not listed at 800-235-4632.

Chemical Charts

Rating Scale

A = May be used for Continuous Service **B** = May be used for Intermittent Service
I = Insufficient data, contact Customer Service **X** = Do not use

Gasket

T = Teflon® **N** = Neoprene **V** = Viton®
S = Silicone **B** = Nitrile

Continental ContiTech Chemical Hose / Hose Tube Polymer													Insta-Lock™ Fitting/Metal			
Temp. (°F)	Fabchem UHMWPE	Gray Flexwing Butyl	Yellow Flexwing Hypalon	Tan Flexwing NR	Orange Flexwing Viton	Flexwing Petroleum Nitrile	Brown Flexwing & ExtremeFlex Brown CPE	Purple Flexwing & ExtremeFlex Purple EPDM	Blue Flexwing & Green XLPE	Chem One & Viper Alphasyn	HIPER Teflon	316 SS	Aluminum	Brass	Gasket	
D																
Diethyl Carbinol	100	A	A	A	A	B	A	I	I	A	A	A	I	I	I	TBN
Diethyl Ketone	100	A	B	X	X	X	X	X	X	A	B	A	I	I	I	T
Diethyl Oxalate	100	A	B	X	B	I	X	A	X	A	B	A	I	I	I	T
Diethyl Phthalate	100	A	A	X	X	X	X	B	X	A	B	A	I	I	I	T
Diethyl Sebacate	100	A	A	X	X	X	X	B	X	A	B	A	A	A	I	T
Diethyl Sulfate	100	A	B	X	X	X	X	A	I	A	A	A	X	I	I	TNS
Diethyl Triamine	100	A	A	X	B	I	B	A	I	A	A	A	I	I	I	T B
Diethylamine	100	A	A	X	B	I	B	B	B	A	B	A	A	I	X	T B
Diethylene Dioxide	100	A	B	X	X	X	X	B	A	A	A	A	X	X	X	T
Diethylene Glycol	100	A	A	A	A	A	A	X	A	A	A	A	A	B	A	TVBN
Diethylene Triamine	100	A	A	X	B	I	B	A	I	A	A	A	I	I	X	T
Dihydroxydiethyl Ether	100	A	A	A	A	A	A	A	A	A	A	A	I	I	I	TVBN
Dihydroxyethyl Amine	100	A	A	X	B	I	B	A	I	A	A	A	I	I	I	T B
Diisobutyl Ketone	100	A	B	X	X	X	X	I	B	A	B	A	I	I	I	T
Diisobutylene	100	A	X	X	X	A	A	X	X	A	B	A	A	I	I	TVB
Diisooctyl Adipate	100	A	A	X	X	X	X	I	I	A	I	A	I	I	I	T
Diisooctyl Phthalate	100	A	A	X	X	X	X	I	I	A	I	A	I	I	I	T
Diisocyanate	100	X	X	X	X	X	X	X	X	X	B	A	I	I	I	T
Diisodecyl Adipate	100	A	A	X	X	X	X	I	I	A	I	A	I	I	I	T
Diisodecyl Phthalate	100	A	A	X	X	X	X	I	I	A	I	A	I	I	I	T
Diisopropanol Amine	100	A	A	X	B	I	B	I	I	A	B	A	I	I	I	T B
Diisopropyl Amine	100	A	A	X	B	I	B	I	I	A	B	A	I	I	I	T B
Diisopropyl Ether	100	A	X	B	X	I	B	I	X	A	B	A	A	I	I	T B
Diisopropyl Ketone	100	A	B	X	X	X	X	I	B	A	B	A	A	A	I	T
Dilauryl Ether	100	A	I	B	X	I	B	I	I	A	B	A	I	I	I	T B
Dimethyl Amine	---	No Hose Recommended For This Application														
Dimethyl Benzene	100	A	X	X	X	A	X	X	X	A	B	A	A	I	I	T V
Dimethyl Ether	100	A	X	B	X	I	B	I	X	B	B	A	I	I	I	T B
Dimethyl Ketone	100	A	A	X	B	X	X	A	A	B	A	A	A	A	I	T
Dimethyl Phenol	100	A	X	X	X	A	X	I	X	A	A	A	I	I	I	T V
Dimethyl Phthalate	100	A	A	X	X	X	X	A	B	A	A	A	A	I	I	T V
Dimethyl Sulfate	100	A	B	X	X	X	X	A	I	A	A	A	I	I	I	T
Dimethyl Sulfide	---	No Hose Recommended For This Application														
Dimethyl Carbinol	100	A	A	A	A	B	A	A	A	A	A	A	A	I	I	TBNS
Dinitrobenzene	100	A	X	X	X	A	X	I	I	A	B	A	I	I	I	T V
Diocetyl Adipate	100	A	A	X	X	X	X	X	B	A	I	A	I	I	I	T
Diocetyl Amine	100	A	A	X	B	I	B	I	I	A	B	A	I	I	I	T
Diocetyl Phthalate	100	A	B	X	X	A	X	X	X	A	A	A	A	I	I	T V

* Fahrenheit to Celsius conversion key: 100°F (38°C), 125°F (52°C), 150°F (66°C), 275°F (135°C) and 500°F (260°C).

This chemical chart is offered as a guide only. There are many variables to be considered with each application. Ratings are for tube polymer only! For explanation of ratings see the initial page of these Chemical Charts in Appendix B. Contact Customer Service for chemicals or polymers not listed at 800-235-4632.

Chemical Charts

Rating Scale

A = May be used for Continuous Service

B = May be used for Intermittent Service

I = Insufficient data, contact Customer Service

X = Do not use

Gasket

T = Teflon®

N = Neoprene

V = Viton®

S = Silicone

B = Nitrile

Continental ContiTech Chemical Hose / Hose Tube Polymer													Insta-Lock™ Fitting/Metal			
Temp. (°F)*	Fabchem UHMWPE	Gray Flexwing Butyl	Yellow Flexwing Hypalon	Tan Flexwing NR	Orange Flexwing Viton	Flexwing Petroleum Nitrile	Brown Flexwing & ExtremeFlex Brown CPE	Purple Flexwing & ExtremeFlex Purple EPDM	Blue Flexwing & Green XLPE	Chem One & Viper Alphasyn	HIPER Teflon	316 SS	Aluminum	Brass	Gasket	
D																
Diocetyl Sebacate	100	A	A	X	X	X	X	X	B	A	I	A	I	I	I	T V
Dioxane	100	A	B	X	X	X	X	B	X	A	A	A	A	I	I	T
Dioxolane	100	A	X	X	X	I	X	B	X	A	B	A	I	I	I	T
Diphenyl Phthalate	100	A	A	X	X	X	X	I	I	A	A	A	I	I	I	T
Dipropyl Ketone	100	A	B	X	X	X	X	X	I	A	A	A	I	I	I	T
Dipropylamine	100	A	A	X	B	I	B	B	I	A	A	A	I	I	I	T
Dipropylene Glycol	100	A	A	A	A	A	A	A	I	A	A	A	I	I	I	TVB
Disodium Phosphate	100	A	A	A	A	I	A	A	I	A	A	A	A	I	B	T B
Divinyl Benzene	100	A	X	X	X	A	X	X	X	A	B	A	I	I	I	T V
Dodecyl Benzene	100	A	X	X	X	A	X	I	X	A	B	A	I	I	I	T V
Dodecyl Toluene	100	A	X	X	X	A	X	I	X	A	B	A	I	I	I	T V
Dow-Per	100	A	X	X	X	A	X	I	X	A	B	A	I	I	I	T V
Dowtherm A	100	A	I	X	X	A	X	X	X	A	A	A	I	A	I	T V
Dowtherm E	100	A	X	X	X	A	X	X	X	A	A	I	I	X	I	V
Dowtherm SR-1	100	A	A	A	A	A	A	I	I	A	A	A	I	I	I	TVB
E																
Endolene	100	I	I	I	I	I	I	I	I	I	I	I	I	I	I	I
Epichlorohydrin	---	No Hose Recommended For This Application														
Ethanol	100	A	A	A	A	B	A	A	A	A	A	A	A	B	A	TBN
Ethanol Amine	100	A	A	B	B	I	B	A	B	A	B	A	A	B	I	T B
Ethyl Acetate	100	A	B	X	X	X	X	B	A	A	A	A	A	A	A	T
Ethyl Acetoacetate	100	A	B	X	X	X	X	A	B	A	A	A	B	I	I	T
Ethyl Acrylate	100	A	X	X	X	X	X	B	X	B	B	A	A	A	A	T
Ethyl Alcohol	100	A	A	A	A	A	A	A	A	A	A	A	A	B	A	TVBNS
Ethyl Aldehyde	---	No Hose Recommended For This Application														
Ethyl Aluminum Dichloride	100	X	X	X	X	B	X	I	X	B	I	A	I	I	I	T V
Ethyl Benzene	100	A	X	X	X	A	X	X	X	A	B	A	A	A	X	T V
Ethyl Butanol	100	A	A	A	A	B	A	A	A	A	A	A	I	I	I	T B
Ethyl Butyl Acetate	100	A	A	B	X	X	X	I	I	A	B	A	I	I	I	T
Ethyl Butyl Alcohol	100	A	A	A	A	B	A	A	A	A	A	A	I	I	I	T B
Ethyl Butyl Amine	100	A	A	X	B	I	B	I	I	I	I	A	I	I	I	T B
Ethyl Butyl Ketone	100	A	B	X	X	X	X	X	I	A	A	A	I	I	I	T
Ethyl Butyraldehyde	100	A	B	X	X	X	X	X	I	A	B	A	I	I	I	T
Ethyl Chloride	---	No Hose Recommended For This Application														
Ethyl Dichloride	100	B	X	X	X	B	X	X	X	B	B	A	I	I	I	T V
Ethyl Ether	---	No Hose Recommended For This Application														
Ethyl Formate	100	A	B	X	X	X	X	A	B	A	A	A	A	I	I	T V
Ethyl Hexanol	100	A	A	A	A	B	A	A	A	A	A	A	I	I	I	TBN

* Fahrenheit to Celsius conversion key: 100°F (38°C), 125°F (52°C), 150°F (66°C) and 500°F (260°C).

This chemical chart is offered as a guide only. There are many variables to be considered with each application. Ratings are for tube polymer only! For explanation of ratings see the initial page of these Chemical Charts in Appendix B. Contact Customer Service for chemicals or polymers not listed at 800-235-4632.

Chemical Charts

Rating Scale

A = May be used for Continuous Service **B** = May be used for Intermittent Service
I = Insufficient data, contact Customer Service **X** = Do not use

Gasket

T = Teflon® **N** = Neoprene **V** = Viton®
S = Silicone **B** = Nitrile

Continental ContiTech Chemical Hose / Hose Tube Polymer													Insta-Lock™ Fitting/Metal			
Temp. (°F)*	Fabchem UHMWPE	Gray Flexwing Butyl	Yellow Flexwing Hypalon	Tan Flexwing NR	Orange Flexwing Viton	Flexwing Petroleum Nitrile	Brown Flexwing & ExtremeFlex Brown CPE	Purple Flexwing & ExtremeFlex Purple EPDM	Blue Flexwing & Green XLPE	Chem One & Viper Alphasyn	HIPER Teflon	316 SS	Aluminum	Brass	Gasket	
E																
Ethyl Hexoic Acid	100	A	X	B	X	I	X	I	I	A	A	A	I	I	I	T
Ethyl Hexyl Acetate	100	A	A	B	X	X	X	I	I	A	B	A	I	I	I	T
Ethyl Hexyl Alcohol	100	A	A	A	A	B	A	A	A	A	A	A	I	I	I	TBN
Ethyl Iodide	100	X	X	X	X	B	X	X	X	B	B	A	I	I	I	T V
Ethyl Isobutyl Ether	100	A	X	B	X	I	B	I	X	A	B	A	I	I	I	T
Ethyl Methyl Ketone	100	A	B	X	X	X	X	I	I	A	A	A	A	A	A	T
Ethyl Oxalate	100	A	A	X	A	I	X	A	X	A	B	A	I	I	I	T V
Ethyl Phthalate	100	A	A	X	X	X	X	B	I	A	I	A	I	I	I	T
Ethyl Propyl Ether	100	A	X	B	X	I	B	A	X	A	B	A	I	I	I	T B
Ethyl Propyl Ketone	100	A	B	X	X	X	X	I	I	A	A	A	I	I	I	T
Ethyl Silicate	100	A	A	I	X	I	A	A	I	A	A	A	A	I	I	TBN
Ethyl Sulfate	100	A	B	X	X	X	X	A	I	A	A	A	X	I	I	TBS
Ethylamine	---	No Hose Recommended For This Application														
Ethylene Bromide	100	X	X	X	X	B	X	I	X	B	B	A	A	X	I	T V
Ethylene Chloride	100	B	X	X	X	B	X	I	X	B	B	A	A	B	I	T V
Ethylene Diamine	100	A	A	X	B	I	B	I	B	A	I	A	A	I	I	T B
Ethylene Dibromide	100	X	X	X	X	B	X	I	X	B	B	A	A	X	I	T V
Ethylene Dichloride	100	B	X	X	X	B	X	X	X	B	A	A	A	B	I	T V
Ethylene Glycol	150	A	A	A	A	A	A	A	A	A	A	A	A	A	I	TVBNS
Ethylhexil Phosphorodieth	100	I	X	X	I	I	A	A	X	X	I	I	I	I	I	B
Ex-Tri	100	A	X	X	X	A	X	I	I	A	B	A	I	I	I	T V
F																
Ferric Bromide	150	A	A	A	A	A	A	A	A	A	A	A	I	I	I	TVB
Ferric Chloride	150	A	A	A	A	A	A	A	A	A	A	A	X	X	X	TVBNS
Ferric Sulfate	150	A	A	A	A	A	A	A	A	A	A	A	A	X	X	TVBN
Ferrous Acetate	100	A	A	A	X	X	X	I	I	A	A	A	I	I	I	T
Ferrous Chloride	150	A	A	A	A	B	A	A	A	A	A	A	I	X	X	T B
Ferrous Hydroxide	100	A	A	B	A	X	B	I	I	A	A	A	B	I	I	T N
Ferrous Sulfate	150	A	A	A	A	A	A	A	A	A	A	A	B	X	X	TVBN
Fluoboric Acid 65%	150	B	A	A	A	I	I	A	I	I	A	A	I	I	X	T N
Fluorine (wet)	100	X	X	X	X	X	X	X	X	X	X	B	X	X	X	T
Fluosilicic Acid 50%	150	B	A	A	A	I	I	A	I	I	A	A	A	X	X	T N
Formaldehyde 40%	100	A	A	A	B	B	A	A	A	A	A	A	A	B	I	T B
Formalin	100	A	A	A	B	A	A	A	A	A	A	A	A	B	I	TVB
Formic Acid	100	A	A	X	B	X	X	A	A	B	A	A	B	I	X	T V
Freon 12	100	A	X	X	X	B	B	I	X	B	X	A	A	I	I	T N
Freon 22	100	A	X	X	X	X	X	I	I	B	X	A	A	I	I	T N
Fuel A (ASTM)	100	B	X	X	X	A	A	I	X	B	B	A	A	A	A	TVB

* Fahrenheit to Celsius conversion key: 100°F (38°C), 125°F (52°C), 150°F (66°C), 275°F (135°C) and 500°F (260°C).

This chemical chart is offered as a guide only. There are many variables to be considered with each application. Ratings are for tube polymer only! For explanation of ratings see the initial page of these Chemical Charts in Appendix B. Contact Customer Service for chemicals or polymers not listed at 800-235-4632.

Chemical Charts

Rating Scale

A = May be used for Continuous Service

B = May be used for Intermittent Service

I = Insufficient data, contact Customer Service

X = Do not use

Gasket

T = Teflon®

N = Neoprene

V = Viton®

S = Silicone

B = Nitrile

Continental ContiTech Chemical Hose / Hose Tube Polymer													Insta-Lock™ Fitting/Metal			
Temp. (°F)*	Fabchem UHMWPE	Gray Flexwing Butyl	Yellow Flexwing Hypalon	Tan Flexwing NR	Orange Flexwing Viton	Flexwing Petroleum Nitrile	Brown Flexwing & ExtremeFlex Brown CPE	Purple Flexwing & ExtremeFlex Purple EPDM	Blue Flexwing & Green XLPE	Chem One & Viper Alphasyn	HIPER Teflon	316 SS	Aluminum	Brass	Gasket	
F																
Fuel B (ASTM)	100	B	X	X	X	A	A	I	X	B	B	A	I	I	I	TVB
Fuel Oil	100	A	X	X	X	A	A	X	X	B	B	A	A	A	I	TVB
Furfural	100	A	A	I	I	X	X	A	B	A	A	A	A	A	X	T
Furfuryl Alcohol	100	A	X	I	I	X	I	A	I	A	A	A	A	A	I	T
G																
Gallic Acid	100	A	B	I	A	I	I	A	B	I	B	A	B	I	I	T S
Gasoline	100	B	X	X	X	A	A	B	X	B	B	A	A	I	I	TVB
Glacial Acetic Acid	100	A	B	X	X	X	X	B	A	A	A	A	A	B	X	T
Glucuronic Acid	100	A	X	B	X	I	X	A	I	A	A	A	X	X	A	T
Glycerin	100	A	A	A	A	A	A	A	A	B	A	A	A	A	A	TVBNS
Glyphosate	100	A	I	I	I	I	I	I	A	I	I	I	I	I	I	I
Graffinite	100	I	X	X	X	X	A	A	X	X	I	I	I	I	I	B
Grease	100	A	X	X	X	A	A	I	X	B	A	A	A	A	A	TVB
Green Sulfate Liquor	150	A	A	A	A	I	A	A	A	A	A	A	A	X	X	TBS
H																
Heptanal	100	A	X	X	X	X	X	X	I	A	I	A	I	I	I	T B
Heptane	100	A	X	X	X	A	A	A	X	B	B	A	A	A	I	TVB
Heptane Carboxylic Acid	100	A	X	B	X	A	X	A	I	A	A	A	I	I	I	T V
Hexaldehyde	100	A	X	X	X	X	X	I	X	A	B	A	A	A	I	T
Hexane	100	B	X	X	X	A	A	B	X	B	B	A	A	A	A	TVB
Hexanol	100	A	A	A	A	B	A	A	A	A	A	A	A	I	I	T B
Hexyl Methyl Ketone	100	A	B	X	X	X	X	I	I	A	A	A	I	I	I	T
Hexylamine	100	A	B	X	X	X	X	B	I	A	B	A	I	I	I	T
Hexylene	100	X	X	X	X	A	A	I	X	X	I	A	I	I	I	TVB
Hexylene Glycol	150	A	A	A	A	A	A	A	I	A	A	A	A	B	A	TVBN
Hexyl Alcohol	100	A	A	A	A	B	A	A	X	A	A	A	A	I	I	T B
Hi-Tri	100	A	X	X	X	A	X	I	X	A	B	A	I	I	I	T V
Hydrobromic Acid (37%)	150	B	A	A	A	I	X	A	A	I	A	A	X	X	X	T N
Hydrochloric Acid 38% concentrated, fuming acid	125	A	B	X	I	I	X	X	I	A	I	A	X	X	X	T
Hydrochloric Acid 37%	125	A	B	A	B	X	X	A	B	A	A	A	X	X	X	T
Hydrofluoric Acid (10%)	125	A	A	A	X	I	X	A	I	A	A	A	A	X	X	T N
Hydrofluosilicic Acid	150	B	B	A	A	I	I	A	A	I	A	A	A	X	X	T
Hydrogen Dioxide 10%	100	B	X	X	X	A	X	I	I	I	I	A	A	B	X	T V
Hydrogen Dioxide over 10%	100	B	X	X	X	I	X	I	X	I	I	A	I	I	X	T
Hydrogen Gas	---	No Hose Recommended For This Application														
Hydrogen Peroxide 10% to 50%	100	B	X	X	X	A	X	A	I	I	I	A	I	B	I	TVS

* Fahrenheit to Celsius conversion key: 100°F (38°C), 125°F (52°C), 150°F (66°C), 275°F (135°C) and 500°F (260°C).

This chemical chart is offered as a guide only. There are many variables to be considered with each application. Ratings are for tube polymer only! For explanation of ratings see the initial page of these Chemical Charts in Appendix B. Contact Customer Service for chemicals or polymers not listed at 800-235-4632.

Chemical Charts

Rating Scale

A = May be used for Continuous Service **B** = May be used for Intermittent Service
I = Insufficient data, contact Customer Services **X** = Do not use

Gasket

T = Teflon® **N** = Neoprene **V** = Viton®
S = Silicone **B** = Nitrile

Continental ContiTech Chemical Hose / Hose Tube Polymer													Insta-Lock™ Fitting/Metal			
Temp. (°F)*	Fabchem UHMWPE	Gray Flexwing Butyl	Yellow Flexwing Hypalon	Tan Flexwing NR	Orange Flexwing Viton	Flexwing Petroleum Nitrile	Brown Flexwing & ExtremeFlex Brown CPE	Purple Flexwing & ExtremeFlex Purple EPDM	Blue Flexwing & Green XLPE	Chem One & Viper Alphasyn	HIPER Teflon	316 SS	Aluminum	Brass	Gasket	
H																
Hydrogen Peroxide over 50%	100	X	X	X	X	X	X	X	X	X	I	A	A	I	X	T
I																
Iodine	100	A	I	A	I	I	A	I	B	I	A	I	I	X	TVB	
Iron Acetate	100	A	A	A	X	X	X	I	I	A	A	A	I	I	I	TNS
Iron Hydroxide	100	A	A	B	X	X	B	I	I	A	A	A	I	I	I	TN
Iron Salts	150	A	A	A	A	A	A	A	A	A	A	A	I	I	I	TVBN
Iron Sulfate	150	A	A	A	A	A	A	A	A	A	A	A	I	I	I	TVBN
Iron Sulfide	150	A	A	A	A	A	A	A	A	A	A	A	I	I	I	TVB
Isoamyl Acetate	100	A	A	B	X	X	X	I	X	A	B	A	I	I	I	T
Isoamyl Alcohol	100	A	A	A	A	B	A	A	A	A	A	A	A	I	A	TBN
Isoamyl Bromide	100	B	X	X	X	B	X	I	X	B	I	A	I	I	I	TV
Isoamyl Butyrate	100	B	X	X	X	X	X	I	I	B	B	A	I	I	I	T
Isoamyl Chloride	100	X	X	X	X	B	X	I	I	X	B	A	I	I	I	TV
Isoamyl Ether	100	A	X	B	X	I	B	I	X	A	I	A	I	I	I	T
Isoamyl Phthalate	100	A	A	X	X	X	X	I	I	A	I	A	I	I	I	T
Isobutane	---	No Hose Recommended For This Application														
Isobutanol	100	A	A	A	A	B	A	A	A	A	A	A	A	I	I	TBNS
Isobutyl Acetate	100	A	A	B	X	X	X	B	X	A	B	A	A	B	I	T
Isobutyl Alcohol	100	A	A	A	A	B	X	A	A	A	A	A	A	I	I	TNS
Isobutyl Aldehyde	100	A	B	X	X	X	X	B	I	A	B	A	I	I	I	T
Isobutyl Amine	100	A	B	X	X	X	X	I	I	A	B	A	I	I	I	T
Isobutyl Bromide	100	B	X	X	X	B	X	I	X	X	I	A	I	I	I	TV
Isobutyl Carbinol	100	A	A	A	A	B	A	A	A	A	A	A	A	I	A	TBN
Isobutyl Chloride	100	B	X	X	X	B	X	I	X	X	I	A	I	I	I	TV
Isobutyl Ether	100	A	X	B	X	I	X	I	X	A	I	A	I	I	I	TB
Isobutylene	100	A	X	X	X	A	X	I	X	A	B	A	I	I	I	TV
Isooctane	100	B	X	X	X	A	A	I	X	B	B	A	A	A	A	TVBS
Isopentane	---	No Hose Recommended For This Application														
Isophorone	100	B	A	I	I	I	X	I	A	B	B	A	B	A	I	T
Isopropanol	100	A	A	A	A	B	A	A	A	A	A	A	A	I	I	TVBS
Isopropanol Amine	100	A	A	X	B	X	B	I	I	A	B	A	I	I	I	TB
Isopropyl Acetate	100	A	A	X	X	X	X	B	X	A	A	A	A	I	I	T
Isopropyl Alcohol	100	A	A	A	A	B	A	A	A	A	A	A	A	I	I	TBNS
Isopropyl Amine	100	A	B	X	X	X	X	I	I	A	B	A	I	I	I	T
Isopropyl Benzene	100	A	X	X	X	A	X	X	X	A	B	A	I	I	I	TV
Isopropyl Chloride	---	No Hose Recommended For This Application														
Isopropyl Ether	100	A	X	B	X	I	X	I	X	A	B	A	A	I	I	TB
Isopropyl Toluene	100	A	X	X	X	A	X	I	X	A	I	A	I	I	I	TV

* Fahrenheit to Celsius conversion key: 100°F (38°C), 125°F (52°C), 150°F (66°C), 275°F (135°C) and 500°F (260°C).

This chemical chart is offered as a guide only. There are many variables to be considered with each application. Ratings are for tube polymer only! For explanation of ratings see the initial page of these Chemical Charts in Appendix B. Contact Customer Service for chemicals or polymers not listed at 800-235-4632.

Chemical Charts

Rating Scale

A = May be used for Continuous Service

B = May be used for Intermittent Service

I = Insufficient data, contact Customer Service

X = Do not use

Gasket

T = Teflon®

N = Neoprene

V = Viton®

S = Silicone

B = Nitrile

Continental ContiTech Chemical Hose / Hose Tube Polymer													Insta-Lock™ Fitting/Metal			
Temp. (°F)*	Fabchem UHMWPE	Gray Flexwing Butyl	Yellow Flexwing Hypalon	Tan Flexwing NR	Orange Flexwing Viton	Flexwing Petroleum Nitrile	Brown Flexwing & ExtremeFlex Brown CPE	Purple Flexwing & ExtremeFlex Purple EPDM	Blue Flexwing & Green XLPE	Chem One & Viper Alphasyn	HIPER Teflon		316 SS	Aluminum	Brass	Gasket
J																
Jet Fuels	---	Special Hose Required										A	A	A	TVB	
K																
Kerosene	100	A	X	X	X	A	A	A	X	A	A	A	A	A	I	TVB
L																
Lauryl Alcohol	100	A	A	A	A	B	A	A	A	A	A	A	I	I	I	T B
Lead Acetate	100	A	A	X	X	X	X	A	B	A	A	A	A	X	X	T
Lead Sulfate	150	A	A	A	A	A	A	A	A	A	A	A	A	X	X	TVBN
Ligroin	100	A	X	X	X	A	A	I	X	A	B	A	A	A	I	T V B
Linseed Oil	100	A	A	B	X	A	A	A	B	I	A	A	A	I	A	vTVBNS
Liquefied Natural Gas (LNG)	---	No Hose Recommended For This Application														
Liquefied Petroleum Gas (LPG)	---	No Hose Recommended For This Application														
Lubricating Oils	100	A	X	X	X	A	A	I	X	A	I	A	A	A	A	TV B
M																
MIBK	100	A	X	X	X	X	X	X	X	A	B	A	X	X	X	T
M.E.K.	100	A	X	X	X	X	X	X	X	A	B	A	X	X	X	T
Magnesium Acetate	100	A	A	A	X	X	X	A	I	A	A	A	I	I	I	T
Magnesium Chloride	150	A	A	A	A	A	A	A	A	A	A	A	A	X	I	TVBS
Magnesium Hydrate	150	A	A	B	A	B	B	I	I	A	A	A	A	X	I	T N
Magnesium Hydroxide	150	A	A	B	A	B	B	A	A	A	A	A	A	X	I	TVBN
Magnesium Sulfate	150	A	A	A	A	A	A	A	B	A	A	A	A	I	I	TVBNS
Maleic Acid	100	A	X	X	X	I	X	I	I	B	I	A	A	B	X	T V
Malic Acid	150	B	I	A	A	I	I	I	I	I	I	A	A	B	X	TVBNS
Manganese Sulfate	150	A	A	A	X	A	A	A	A	A	A	A	A	I	I	TVBN
Manganese Sulfide	150	A	A	A	X	A	A	A	A	A	A	A	I	I	I	TVB
Manganese Sulfite	150	A	A	A	X	A	A	A	A	A	A	A	I	I	I	TVB
Methanol	100	A	A	A	A	X	A	A	A	A	A	A	A	I	I	T B
Mesityl Oxide	100	A	B	X	X	X	X	B	X	A	B	A	A	I	I	T
Methyl Alcohol	100	A	A	A	A	B	A	A	A	A	A	A	I	I	I	T B
Methyl (Wood) Alcohol	100	A	A	A	A	X	A	A	A	A	A	A	A	I	I	TBNS
Methyl Acetate	100	A	A	B	X	X	X	A	A	A	A	A	A	I	I	T
Methyl Acetoacetate	100	A	B	X	X	X	X	A	I	A	A	A	I	I	I	T
Methyl Acetone	---	No Hose Recommended For This Application														
Methyl Amyl Acetate	100	B	A	B	X	X	X	I	X	A	B	A	I	I	I	T
Methyl Amyl Alcohol	100	A	A	A	A	B	A	A	A	A	A	A	I	I	I	TBN
Methyl Amyl Carbinol	100	A	A	A	A	B	A	A	A	A	A	A	I	I	I	T B
Methyl Amyl Ketone	100	A	B	X	X	X	X	X	I	A	B	A	I	I	I	T
Methyl Benzene	100	A	X	X	X	A	X	X	X	A	B	A	A	A	A	T V
Methyl Butanol	100	A	A	A	A	B	A	A	I	A	A	A	A	I	A	TBN

* Fahrenheit to Celsius conversion key: 100°F (38°C), 125°F (52°C), 150°F (66°C), 275°F (135°C) and 500°F (260°C).

This chemical chart is offered as a guide only. There are many variables to be considered with each application. Ratings are for tube polymer only! For explanation of ratings see the initial page of these Chemical Charts in Appendix B. Contact Customer Service for chemicals or polymers not listed at 800-235-4632.

Chemical Charts

Rating Scale

A = May be used for Continuous Service B = May be used for Intermittent Service
 I = Insufficient data, contact Customer Service X = Do not use

Gasket

T = Teflon® N = Neoprene V = Viton®
 S = Silicone B = Nitrile

Continental ContiTech Chemical Hose / Hose Tube Polymer													Insta-Lock™ Fitting/Metal			
Temp. (°F)*	Fabchem UHMWPE	Gray Flexwing Butyl	Yellow Flexwing Hypalon	Tan Flexwing NR	Orange Flexwing Viton	Flexwing Petroleum Nitrile	Brown Flexwing & ExtremeFlex Brown CPE	Purple Flexwing & ExtremeFlex Purple EPDM	Blue Flexwing & Green XLPE	Chem One & Viper Alphasyn	HIPER Teflon	316 SS	Aluminum	Brass	Gasket	
M																
Methyl Butanone	100	A	B	X	X	X	X	B	B	A	B	A	I	I	I	T
Methyl Butyl Ketone	100	A	B	X	X	X	X	X	I	A	B	A	A	B	I	T
Methyl Carbitol	100	A	A	A	X	I	X	A	I	A	A	A	I	I	I	T
Methyl Cellosolve	100	A	A	A	X	I	X	A	A	A	A	A	A	B	A	T
Methyl Chloride	---	No Hose Recommended For This Application														
Methyl Cyclohexane	100	A	X	X	X	B	X	B	X	B	I	A	I	I	I	T V
Methyl Ethyl Ketone (M.E.K.)	100	A	X	X	X	X	X	X	X	A	B	A	X	X	X	T
Methyl Hexanol	100	A	A	A	B	A	A	A	A	A	A	A	I	I	I	TVB
Methyl Hexanone	100	A	B	X	X	X	X	X	I	A	B	A	I	I	I	T
Methyl Hexyl Ketone	100	A	B	X	X	X	X	X	I	A	B	A	I	I	I	T
Methyl Isobutyl Carbinol	100	A	A	A	A	B	A	A	A	A	A	A	B	I	I	TBN
Methyl Isobutyl Ketone (MIBK)	100	A	X	X	X	X	X	X	X	A	B	A	X	X	X	T
Methyl Isopropyl Ketone	100	A	B	X	X	X	X	B	B	A	B	A	A	I	I	T
Methyl Normal Amyl Ketone	100	A	B	X	X	X	X	I	I	A	B	A	I	I	I	T
Methyl Propyl Carbinol	100	A	A	A	A	B	A	A	A	A	A	A	I	I	I	T B
Methyl Propyl Ether	100	A	X	B	X	I	X	I	X	A	B	A	I	I	I	T
Methyl Propyl Ketone	100	A	B	X	X	X	X	B	I	A	B	A	I	I	I	T
Methyl Tertiary Butyl Ether (MTBE)	100% Concentrate	X	X	X	X	X	X	X	X	A	B	I	I	I	I	I
Methylalyl Acetate	100	A	A	B	X	X	X	I	A	A	A	A	I	I	I	T
Methylalyl Chloride	100	A	X	X	X	X	X	X	I	B	I	A	I	I	I	T
Methyldiethanolamine	100	A	X	X	X	X	A	A	X	A	A	A	I	I	I	T B
Methylene Bromide	100	B	X	X	X	B	X	I	X	B	A	A	I	I	I	T V
Methylene Chloride	---	No Hose Recommended For This Application														
Metribuzin	100	A	I	I	I	I	I	I	A	I	I	A	I	I	I	T
Mineral Spirits	100	A	X	X	X	B	A	I	X	A	B	A	A	A	I	T B
Monochloroacetic Acid	100	A	X	X	B	I	X	A	X	A	A	A	A	X	X	T
Monochlorobenzene	100	B	X	X	X	A	X	X	X	B	B	A	A	B	B	T V
Monochlorodifluoromethane	100	I	X	X	X	X	X	I	I	I	I	A	A	I	I	T N
Monoethanol Amine	100	A	A	X	B	I	B	A	B	A	B	A	A	B	I	T N
Monoethyl Amine	---	No Hose Recommended For This Application														
Monoisopropanol Amine	100	A	A	X	B	I	B	I	I	A	B	A	I	I	I	TBw

* Fahrenheit to Celsius conversion key: 100°F (38°C), 125°F (52°C), 150°F (66°C), 275°F (135°C) and 500°F (260°C).

This chemical chart is offered as a guide only. There are many variables to be considered with each application. Ratings are for tube polymer only! For explanation of ratings see the initial page of these Chemical Charts in Appendix B. Contact Customer Service for chemicals or polymers not listed at 800-235-4632.

Chemical Charts

Rating Scale

A = May be used for Continuous Service

B = May be used for Intermittent Service

I = Insufficient data, contact Customer Service

X = Do not use

Gasket

T = Teflon®

N = Neoprene

V = Viton®

S = Silicone

B = Nitrile

	Continental ContiTech Chemical Hose / Hose Tube Polymer													Insta-Lock™ Fitting/Metal			
	Temp. (°F)*	Fabchem UHMWPE	Gray Flexwing Butyl	Yellow Flexwing Hypalon	Tan Flexwing NR	Orange Flexwing Viton	Flexwing Petroleum Nitrile	Brown Flexwing & ExtremeFlex Brown CPE	Purple Flexwing & ExtremeFlex Purple EPDM	Blue Flexwing & Green XLPE	Chem One & Viper Alphasyn	HIPER Teflon	316 SS	Aluminum	Brass	Gasket	
M																	
Methylpyrrolidone	100	A	X	X	X	X	X	X	X	A	I	A	I	I	I	T	
Muriatic Acid	125	A	X	X	A	I	X	A	X	A	A	A	X	X	X	T	
N																	
Naphtha	100	A	X	X	X	A	A	A	X	A	A	A	A	A	I	TVBN	
Naphthalene	100	A	X	X	X	A	X	I	X	A	I	A	A	B	I	TV	
Natural Gas	---	No Hose Recommended For This Application															
Neohexane	100	A	X	X	X	A	A	B	X	A	B	A	A	A	I	TVB	
Neu-Tri	100	A	X	X	X	A	X	I	X	A	B	A	I	I	I	TV	
Nickel Chloride	150	A	A	A	A	A	A	A	A	A	A	A	B	X	X	TVBS	
Nickel Nitrate	150	A	A	A	A	A	A	A	A	A	A	A	B	X	X	TVBN	
Nickel Sulfate	150	A	A	A	A	A	A	A	A	A	A	A	A	X	X	TVBNS	
Nitric Acid 25%	100	B	B	X	X	X	X	X	X	B	A	A	A	X	X	TV	
Nitric Acid 37%	100	X	X	X	X	X	X	X	X	X	A	A	A	X	X	TV	
Nitric Acid 40%-60%	100	X	X	X	X	X	X	X	X	B	A	A	A	X	X	TV	
Nitric Acid 70%	100	X	X	X	X	X	X	X	X	B	A	B	A	X	X	T	
Nitro Benzene	100	A	X	X	X	B	X	X	X	A	B	A	A	B	X	T	
Nitrogen Gas	100	A	A	A	A	A	A	A	A	A	A	A	A	I	I	TVBNS	
Nitrous Oxide	100	A	A	A	A	A	A	A	A	A	A	A	A	I	X	TVBNS	
Nonenes	100	A	X	X	X	A	A	I	X	A	B	A	I	I	I	V B	
O																	
Octadecanoic Acid	100	A	B	X	X	I	A	A	B	A	A	A	A	B	A	T B	
Octane	100	B	X	X	X	A	A	A	X	B	B	A	B	I	B	TVB	
Octanol	100	A	A	A	A	B	A	A	X	A	A	A	A	I	I	TBN	
Octyl Acetate	100	A	A	A	X	X	X	X	I	A	B	A	I	I	I	T	
Octyl Alcohol	100	A	A	A	A	B	A	A	X	A	A	A	A	I	I	T B	
Octyl Aldehyde	100	A	X	X	X	X	X	I	I	A	I	A	I	I	I	T	
Octyl Amine	100	A	B	X	X	X	X	B	I	A	B	A	I	I	I	T	
Octyl Carbinol	100	A	A	A	A	B	A	A	A	A	A	A	I	I	I	T B	
Octylene Glycol	100	A	A	A	A	A	A	A	A	A	A	A	I	I	I	TVB	
Oil Petroleum	100	B	X	X	X	A	A	A	X	A	B	A	A	A	X	TVB	
Oleic Acid	100	A	B	X	X	I	B	A	X	A	B	A	A	B	X	T B	
Oleum	100	X	X	X	X	X	X	X	X	X	X	A	I	X	X	TV	
Organic Fatty Acids	100	A	X	X	X	X	A	A	X	A	B	A	A	I	I	T B	
Orthodichlorobenzene	100	A	X	X	X	A	X	I	X	A	B	A	I	I	I	TV	
Orthodichlorobenzol	100	A	X	X	X	A	X	I	X	A	I	A	I	I	I	TV	
Orthoxylene	100	B	X	X	X	A	X	I	X	A	B	A	I	I	I	TV	
Oxalic Acid	100	A	A	X	X	I	X	A	B	I	B	A	A	B	X	T S	
Oxygen	---	No Hose Recommended For This Application															
Ozone	100	A	B	B	X	I	X	A	A	I	B	A	I	I	I	T S	

* Fahrenheit to Celsius conversion key: 100°F (38°C), 125°F (52°C), 150°F (66°C), 275°F (135°C) and 500°F (260°C).

This chemical chart is offered as a guide only. There are many variables to be considered with each application. Ratings are for tube polymer only! For explanation of ratings see the initial page of these Chemical Charts in Appendix B. Contact Customer Service for chemicals or polymers not listed at 800-235-4632.

Chemical Charts

Rating Scale

A = May be used for Continuous Service B = May be used for Intermittent Service
 I = Insufficient data, contact Customer Service X = Do not use

Gasket

T = Teflon® N = Neoprene V = Viton®
 S = Silicone B = Nitrile

Continental ContiTech Chemical Hose / Hose Tube Polymer													Insta-Lock™ Fitting/Metal			
Temp. (°F)*	Fabchem UHMWPE	Gray Flexwing Butyl	Yellow Flexwing Hypalon	Tan Flexwing NR	Orange Flexwing Viton	Flexwing Petroleum Nitrile	Brown Flexwing & ExtremeFlex Brown CPE	Purple Flexwing & ExtremeFlex Purple EPDM	Blue Flexwing & Green XLPE	Chem One & Viper Alphasyn	HIPER Teflon	316 SS	Aluminum	Brass	Gasket	
P																
Palmitic Acid	100	A	A	B	X	I	A	A	B	B	A	A	I	X	TBS	
Papermakers Alum	150	A	A	A	A	A	A	A	A	A	A	I	I	I	TVBN	
Paradichlorobenzol	100	B	X	X	X	A	X	I	X	A	I	I	I	I	T V	
Paraffin	150	A	B	X	X	A	A	A	X	X	I	A	A	A	TVB	
Paraldehyde	100	A	B	X	X	X	X	I	B	A	B	A	A	I	T	
Paraxylene	100	A	X	X	X	A	X	I	X	A	B	A	I	I	T V	
Pelargonic Acid	100	A	A	X	X	I	A	I	I	A	I	A	I	I	T B	
Pentachloroethane	100	A	X	X	X	A	X	I	X	A	I	A	A	B	X T V	
Pentane	---	No Hose Recommended For This Application														
Pentanol	100	A	A	A	A	B	A	A	A	A	A	I	I	I	TBN	
Pentanone	100	A	B	X	X	X	X	B	I	A	B	A	I	I	T	
Perchloroethylene	100	B	X	X	X	A	X	X	X	A	B	A	A	B	X T V	
Petroleum Ether (Ligroin)	100	A	X	X	X	A	A	A	X	A	B	A	A	A	TVB	
Petroleum - Crude	100	A	X	X	X	A	A	A	X	A	B	A	A	A	TVB	
Petroleum Oils	100	A	X	X	X	A	A	A	X	A	B	A	A	A	TVB	
Phenol	125	A	A	X	X	A	X	A	X	A	B	A	A	B	T V	
Phenolsulfonic Acid	100	X	X	X	X	X	X	A	I	B	B	A	B	I	T	
Phenyl Chloride	100	A	X	X	X	A	X	X	X	A	B	A	A	B	T V	
Phosphoric Acid 10%	150	A	A	A	A	X	A	A	A	A	A	A	A	X	TVBN	
Phosphoric Acid 10-85%	100	A	A	A	B	X	X	A	A	A	A	A	A	X	TVN	
Pine Oil	100	A	X	X	X	A	X	B	X	A	B	A	A	I	X T V	
Pinene	100	A	X	X	X	A	B	B	X	A	B	A	B	I	T V	
Polyethylene Glycol	150	A	A	A	A	A	A	A	A	A	A	A	I	I	TVBN	
Polypropylene Glycol	150	A	A	A	A	A	A	A	A	A	A	A	I	I	TVB	
Potassium Acetate	100	A	A	B	X	X	A	B	A	A	A	A	A	X	T B	
Potassium Bisulfate	150	A	A	A	A	A	A	A	A	A	A	A	A	I	TVBN	
Potassium Bisulfite	150	A	A	A	A	A	A	A	A	A	A	A	I	I	TVBN	
Potassium Carbonate	150	A	A	A	A	A	A	A	A	A	A	A	A	X	TVBNS	
Potassium Chloride	150	A	A	A	A	A	A	A	A	A	A	A	A	X	TVBNS	
Potassium Chromate	150	B	A	X	I	I	I	A	I	B	B	A	B	I	TVBN	
Potassium Dichromate	150	B	A	X	I	I	I	A	I	B	B	A	A	B	TVBNS	
Potassium Hydrate	150	A	A	B	A	X	B	A	B	A	A	A	A	X	T S	
Potassium Hydroxide	150	B	A	B	A	X	B	A	B	A	A	A	A	X	T N	
Potassium Nitrate	150	A	A	A	A	A	A	A	A	A	A	A	A	B	TVBNS	
Potassium Permanganate	100	A	A	A	A	A	B	I	I	A	A	A	A	I	TVS	
Potassium Silicate	150	A	A	A	A	A	A	A	A	A	A	A	A	I	TVBNS	
Potassium Sulfate	150	A	A	A	A	A	A	A	A	A	A	A	A	B	TVBNS	
Potassium Sulfide	150	A	A	A	A	A	A	A	A	A	A	A	A	X	TVBNS	

* Fahrenheit to Celsius conversion key: 100°F (38°C), 125°F (52°C), 150°F (66°C), 275°F (135°C) and 500°F (260°C).

This chemical chart is offered as a guide only. There are many variables to be considered with each application. Ratings are for tube polymer only! For explanation of ratings see the initial page of these Chemical Charts in Appendix B. Contact Customer Service for chemicals or polymers not listed at 800-235-4632.

Chemical Charts

Rating Scale

A = May be used for Continuous Service

B = May be used for Intermittent Service

I = Insufficient data, contact Customer Service

X = Do not use

Gasket

T = Teflon®

N = Neoprene

V = Viton®

S = Silicone

B = Nitrile

Continental ContiTech Chemical Hose / Hose Tube Polymer													Insta-Lock™ Fitting/Metal			
Temp. (°F)*	Fabchem UHMWPE	Gray Flexwing Butyl	Yellow Flexwing Hypalon	Tan Flexwing NR	Orange Flexwing Viton	Flexwing Petroleum Nitrile	Brown Flexwing & ExtremeFlex Brown CPE	Purple Flexwing & ExtremeFlex Purple EPDM	Blue Flexwing & Green XLPE	Chem One & Viper Alphasyn	HIPER Teflon	316 SS	Aluminum	Brass	Gasket	
P																
Potassium Sulfite	150	A	A	A	A	A	A	A	A	A	A	A	I	X	TVBNS	
Propanediol	100	A	A	A	A	A	A	A	A	A	A	I	I	I	TVBS	
Propane Gas	---	X	X	X	X	X	X	X	X	X	X	X	X	X	TVB	
Propanol	100	A	A	A	A	B	A	A	A	A	A	A	I	I	TVB	
Propyl Acetate	100	A	A	B	X	X	X	B	X	A	B	A	A	I	T	
Propyl Alcohol	100	A	A	A	A	B	A	A	A	A	A	A	I	I	T B	
Propyl Aldehyde	100	A	B	X	X	X	X	X	I	A	B	A	I	I	T	
Propyl Chloride	---	No Hose Recommended For This Application														
Propylene Diamine	100	A	A	X	B	I	B	A	I	A	I	A	I	I	T B	
Propylene Dichloride	100	B	X	X	X	B	X	X	X	B	I	A	A	X	T V	
Propylene Glycol	100	A	A	A	A	A	A	A	A	A	A	A	I	I	TVBS	
Propylene Tetramer	100	A	X	X	X	X	A	A	X	A	B	I	I	I	B	
S																
Sea Water	100	A	A	A	A	A	A	A	A	A	A	A	I	X	TVBNS	
Sewage	100	A	X	A	X	I	A	A	A	A	A	A	X	I	TBNS	
Silicate of Soda	100	A	A	A	A	A	A	A	A	A	A	A	X	X	TVBNS	
Soap	100	A	X	X	X	X	A	A	X	X	I	A	X	X	TBNS	
Soda Ash	100	A	A	A	A	A	A	A	A	A	A	A	X	I	TVBNS	
Soda, Caustic	100	A	A	B	A	X	B	A	A	A	A	A	X	X	TNS	
Soda, Lime	100	A	A	B	A	X	B	A	A	A	A	I	I	I	TVB	
Soda, Niter	100	A	A	A	A	A	A	A	B	A	A	A	B	I	TVB	
Sodium Acetate	100	A	A	A	X	X	A	A	B	B	B	A	I	A	TNS	
Sodium Aluminate	100	A	A	A	A	A	A	A	A	A	A	A	I	I	TVBN	
Sodium Bisulfate	150	A	A	A	A	A	A	A	A	A	A	A	X	X	TVBNS	
Sodium Bisulfite	150	A	A	A	A	A	A	A	A	A	A	A	X	X	TVBNS	
Sodium Carbonate	150	A	A	A	A	A	A	A	A	A	A	A	X	I	TVBNS	
Sodium Chloride (Brine)	150	A	A	A	A	A	A	A	A	A	A	A	X	I	TVBNS	
Sodium Chromate	150	X	A	X	I	I	I	A	I	X	I	A	A	A	TVBN	
Sodium Dichromate	150	A	A	X	I	I	I	A	A	A	A	A	I	X	T	
Sodium Hydrate	150	A	A	B	A	X	B	A	A	A	A	B	X	X	T N	
Sodium Hydrosulfide	100	A	X	X	X	X	A	A	X	A	I	A	B	I	T B	
Sodium Hydroxide (50%)	150	A	A	B	A	X	B	A	A	A	A	A	X	X	TBN	
Sodium Hypochlorite	100	B	B	X	X	B	X	A	A	X	B	A	X	X	TVS	
Sodium Nitrate	150	A	A	A	A	A	A	A	B	A	A	A	B	I	TVBNS	
Sodium Silicate	150	A	A	A	A	A	A	A	A	A	A	A	X	X	TVBNS	
Sodium Sulfate	150	A	A	A	A	A	A	A	A	A	A	A	B	X	TVBNS	
Sodium Sulfide	150	A	A	A	A	A	A	A	A	A	A	A	X	X	TVBN	
Sodium Sulfite	150	A	A	A	A	A	A	A	B	A	A	A	I	I	TVBNS	
Sodium Sulphhydrate	100	A	X	X	X	X	A	A	X	A	B	A	I	I	T B	

* Fahrenheit to Celsius conversion key: 100°F (38°C), 125°F (52°C), 150°F (66°C), 275°F (135°C) and 500°F (260°C).
 This chemical chart is offered as a guide only. There are many variables to be considered with each application. Ratings are for tube polymer only! For explanation of ratings see the initial page of these Chemical Charts in Appendix B. Contact Customer Service for chemicals or polymers not listed at 800-235-4632.

Chemical Charts

Rating Scale

A = May be used for Continuous Service B = May be used for Intermittent Service
 I = Insufficient data, contact Customer Service X = Do not use

Gasket

T = Teflon® N = Neoprene V = Viton®
 S = Silicone B = Nitrile

Continental ContiTech Chemical Hose / Hose Tube Polymer													Insta-Lock™ Fitting/Metal			
Temp. (°F)	Fabchem UHMWPE	Gray Flexwing Butyl	Yellow Flexwing Hypalon	Tan Flexwing NR	Orange Flexwing Viton	Flexwing Petroleum Nitrile	Brown Flexwing & ExtremeFlex Brown CPE	Purple Flexwing & ExtremeFlex Purple EPDM	Blue Flexwing & Green XLPE	Chem One & Viper Alphasyn	HIPER Teflon	316 SS	Aluminum	Brass	Gasket	
S																
Sodium Thiosulfate	150	A	A	A	A	A	A	A	A	A	A	A	I	X	TVBNS	
Stannic Chloride	150	A	A	A	A	I	A	A	A	A	A	X	X	X	T B	
Stannic Sulfide	150	A	A	A	A	I	A	A	A	A	A	I	I	I	TBN	
Stannous Chloride	150	A	A	A	A	I	A	A	B	A	A	A	X	X	T B	
Stannous Sulfide	150	A	A	A	A	I	A	A	A	A	A	I	I	I	T B	
Stearic Acid	100	A	B	X	X	I	A	A	B	A	A	A	B	A	TVB	
Stoddard Solvent	100	A	X	X	X	A	A	A	X	A	B	A	A	I	TVB	
Styrene	100	B	X	X	X	A	X	X	X	I	A	A	I	I	T V	
Sulfamic Acid (>10%)	100	X	A	B	B	I	B	A	I	I	A	I	I	I	TVN	
Sulfonic Acid	100	B	X	X	X	X	X	I	I	B	I	A	I	I	TVN	
Sulfur Dioxide (Liquid)	100	B	B	B	I	X	I	I	I	X	I	A	A	I	T N	
Sulfuric Acid 25%	150	A	A	B	B	I	X	A	A	A	A	I	X	X	TVN	
Sulfuric Acid 93%	100	X	X	B	X	B	X	X	B	A	A	I	X	X	T V	
Sulfuric Acid 93-98%	100	X	X	X	X	B	X	X	X	I	B	A	I	X	T V	
Sulfuric Acid Fuming	100	X	X	X	X	X	X	X	X	X	X	A	I	X	T	
Sulfurous Acid 10%	150	A	A	A	A	I	X	A	A	A	A	I	X	X	T	
Sulfurous Acid 10-75%	100	A	A	A	A	I	X	A	A	A	A	I	X	X	T	
Sulphonate	100	I	X	X	X	X	A	A	X	X	I	I	I	I	B	
T																
Tall Oil	100	A	X	X	X	A	A	I	X	I	I	A	A	X	TVB	
Tallow	150	A	X	X	X	I	A	A	X	I	I	A	A	I	TBNS	
Tannic Acid	150	A	A	A	A	I	B	A	X	I	I	A	A	X	TVBN	
Tar	---	Special Hose Required										A	A	I	I	
Tartaric Acid	150	A	A	A	A	I	A	A	A	A	A	A	A	I	A	
Tergitol	100	X	I	I	I	I	I	I	I	I	I	A	I	I	T	
Tertiary Butyl Alcohol	100	A	A	A	A	B	A	A	A	A	A	I	I	I	T B	
Tetrachlorobenzene	100	B	X	X	X	B	X	I	X	B	I	A	I	I	T	
Tetrachloroethane	100	A	X	X	X	A	X	I	X	X	I	A	A	X	T V	
Tetrachloroethylene	100	A	X	X	X	A	X	X	X	A	B	A	A	B	T V	
Tetrachloromethane	100	A	X	X	X	A	X	X	X	X	B	A	A	I	T V	
Tetrachloronaphthalene	100	B	X	X	X	B	X	I	X	X	I	A	I	I	T	
Tetradecanol	100	A	A	A	A	B	A	A	A	A	A	A	I	I	T B	
Tetraethylene Glycol	150	A	A	A	A	A	A	A	A	A	A	I	I	I	TVB	
Tetraethylene Lead	100	X	X	X	X	A	X	X	X	X	I	A	I	I	T V	
Tetrahydrofuran	100	B	X	X	X	X	X	X	X	B	X	A	A	B	T	
THF	100	B	X	X	X	X	X	X	X	B	X	A	A	B	T	
Thionyl Chloride	100	X	I	I	I	I	I	I	I	I	X	A	X	X	T	
Tin Chloride	100	A	A	A	A	I	A	A	A	A	A	A	X	X	TVB	
Tin Tetrachloride	150	B	A	A	A	I	A	A	A	A	A	A	X	X	T B	

* Fahrenheit to Celsius conversion key: 100°F (38°C), 125°F (52°C), 150°F (66°C), 275°F (135°C) and 500°F (260°C).

This chemical chart is offered as a guide only. There are many variables to be considered with each application. Ratings are for tube polymer only! For explanation of ratings see the initial page of these Chemical Charts in Appendix B. Contact Customer Service for chemicals or polymers not listed at 800-235-4632.

Chemical Charts

Rating Scale

A = May be used for Continuous Service

B = May be used for Intermittent Service

I = Insufficient data, contact Customer Service

X = Do not use

Gasket

T = Teflon®

N = Neoprene

V = Viton®

S = Silicone

B = Nitrile

	Continental ContiTech Chemical Hose / Hose Tube Polymer												Insta-Lock™ Fitting/Metal			
	Temp. (°F)*	Fabchem UHMWPE	Gray Flexwing Butyl	Yellow Flexwing Hypalon	Tan Flexwing NR	Orange Flexwing Viton	Flexwing Petroleum Nitrile	Brown Flexwing & ExtremeFlex Brown CPE	Purple Flexwing & ExtremeFlex Purple EPDM	Blue Flexwing & Green XLPE	Chem One & Viper Alphasyn	HIPER Teflon	316 SS	Aluminum	Brass	Gasket
T																
Titanium Tetrachloride	100	B	X	X	X	A	B	X	X	A	B	A	B	X	X	T V
Toluene	100	A	X	X	X	A	X	X	X	B	B	A	A	A	A	T V
Toluidine	100	X	I	I	I	I	I	I	I	I	A	I	I	I	I	T
Toluol	100	A	X	X	X	A	X	X	X	B	B	A	A	A	A	T V
Transformer Oil	100	X	I	I	I	I	I	I	I	I	A	A	I	I	I	T
Transmission Oil 'A'	150	B	X	X	X	A	A	I	X	I	I	A	A	A	A	TVB
Tributoxy Ethylsulphate	100	I	A	X	X	A	X	X	A	X	I	I	I	I	I	V
Tributyl Amine	100	A	A	X	B	I	B	A	I	A	A	A	I	I	I	T
Tributyl Phosphate	100	A	A	X	X	X	X	X	X	A	I	A	A	I	X	T
Trichlorobenzene	100	B	X	X	X	B	X	X	X	B	I	A	I	A	I	T
Trichloroethane	100	A	X	X	X	A	X	B	X	X	B	A	A	I	I	T V
Trichloroethylene	100	X	X	X	X	A	X	X	X	X	B	A	A	I	I	T V
Trichloropropane	100	A	X	X	X	A	X	I	X	A	I	A	A	X	I	T V
Tricresylphosphate	100	A	A	X	X	A	X	A	A	A	I	A	A	X	I	T V
Tridecanol	100	A	A	A	A	B	A	A	A	A	A	A	I	I	I	T B
Triethanolamine	100	A	A	X	B	X	B	A	A	A	A	A	A	I	X	T B
Triethylamine	100	A	A	X	B	I	B	A	I	A	A	A	A	I	I	TVBN
Triethylene Glycol	150	A	A	A	A	I	A	A	I	A	A	A	A	A	I	T B
Trifluralin (Trefalin)	100	A	X	X	X	A	X	X	X	A	I	A	I	I	I	T V
Triphenyl Phosphate	100	A	A	X	X	I	X	I	I	A	I	A	A	I	I	T
Tripolyphosphate	100	X	I	I	I	I	I	I	I	I	A	I	I	I	I	T
Trisodium Phosphate	150	A	A	A	A	A	A	A	A	A	A	A	A	X	I	TVBNS
Turpentine	100	A	X	X	X	A	A	B	X	A	X	A	A	A	A	T V B
U																
Urea	100	A	A	I	I	I	X	A	I	A	A	A	A	B	I	TVBN
Undecanol	100	B	A	A	A	B	A	A	A	A	A	A	I	I	I	T B
V																
V.M. & P. Naptha	100	A	X	X	X	A	A	I	X	A	I	A	I	I	I	TVBS
Vinyl Acetate	100	A	A	B	X	X	X	A	X	A	B	A	A	I	X	T V
Vinyl Benzene	100	A	X	X	X	A	X	X	X	A	I	A	A	I	I	T V
Vinyl Chloride	---	No Hose Recommended For This Application														
Vinyl Ether	---	No Hose Recommended For This Application														
Vinyl Toluene	100	A	X	X	X	A	X	X	X	A	I	A	I	I	I	T V
Vinyl Trichloride	100	A	X	X	X	A	X	X	X	A	B	A	A	I	I	T V
W																
Water	180	A	A	A	A	A	A	A	A	A	A	A	A	I	I	TVBNS
Wax	100	A	X	X	X	X	A	A	X	X	X	A	A	I	I	TVBN
White Oil	100	A	X	X	X	I	A	A	X	I	I	A	I	I	I	TVB
Wood Alcohol	100	A	A	A	A	X	A	A	A	A	A	A	A	I	I	TBNS

* Fahrenheit to Celsius conversion key: 100°F (38°C), 125°F (52°C), 150°F (66°C), 275°F (135°C) and 500°F (260°C).
 This chemical chart is offered as a guide only. There are many variables to be considered with each application. Ratings are for tube polymer only! For explanation of ratings see the initial page of these Chemical Charts in Appendix B. Contact Customer Service for chemicals or polymers not listed at 800-235-4632.

Chemical Charts

Rating Scale

A = May be used for Continuous Service **B** = May be used for Intermittent Service
I = Insufficient data, contact Customer Service **X** = Do not use

Gasket

T = Teflon® **N** = Neoprene **V** = Viton®
S = Silicone **B** = Nitrile

Continental ContiTech Chemical Hose / Hose Tube Polymer													Insta-Lock™ Fitting/Metal			
Temp. (°F)	Fabchem UHMWPE	Gray Flexwing Butyl	Yellow Flexwing Hypalon	Tan Flexwing NR	Orange Flexwing Viton	Flexwing Petroleum Nitrile	Brown Flexwing & ExtremeFlex Brown CPE	Purple Flexwing & ExtremeFlex Purple EPDM	Blue Flexwing & Green XLPE	Chem One & Viper Alphasyn	HIPER Teflon	316 SS	Aluminum	Brass	Gasket	
X																
Xylene (Xylol)	100	X	X	X	X	A	X	X	X	A	B	A	A	I	I	T V
Xylidine	100	B	X	X	X	X	X	X	X	B	B	A	B	A	I	T
Z																
Zinc Carbonate	150	A	A	A	A	A	A	A	A	A	A	A	B	B	X	TVBN
Zinc Chloride	150	A	A	A	A	A	A	A	A	A	A	A	A	X	X	TVBNS
Zinc Chromate	150	A	A	X	I	I	I	A	X	B	I	A	I	I	I	T
Zinc Phosphate	100	A	X	X	X	X	A	A	A	X	I	A	I	I	I	TBNS
Zinc Sulfate	150	A	A	A	A	A	A	A	A	A	A	A	A	X	X	TVBNS

* Fahrenheit to Celsius conversion key: 100°F (38°C), 125°F (52°C), 150°F (66°C), 275°F (135°C) and 500°F (260°C).

This chemical chart is offered as a guide only. There are many variables to be considered with each application. Ratings are for tube polymer only! For explanation of ratings see the initial page of these Chemical Charts in Appendix B. Contact Customer Service for chemicals or polymers not listed at 800-235-4632.

Spiraflex Hose Chemical Resistance Guide

Rating Scale

A = May be used for Continuous Service **B** = May be used for Intermittent Service
I = Insufficient data contact Customer Service **X** = Do not use

Thermoplastic Hose

	Temp. (F°)	Polyurethane Spirathane	PVC Pliovic Plus	TPE Arvac SW	TPR Green Hornet XF
A					
Acetaldehyde	70°	X	X	I	X
Acetic Acid, Conc.	70°	X	B	I	I
Acetic Acid, Dilute 10	70°	B	A	I	I
Acetic Acid, Glacial	70°	X	B	I	X
Acetic Aldehyde	70°	I	X	I	X
Acetic Anhydride	70°	X	X	X	X
Acetic Ester	70°	X	X	X	B
Acetic Ether	70°	X	X	X	I
Acetone	70°	X	X	X	B
Acetone Cyanohydrin	70°	X	X	X	I
Acetyl Acetone	70°	X	X	X	I
Acetyl Chloride	70°	X	I	X	X
Acetylene Dichloride	70°	I	X	I	X
Acetylene Tetrachloride	70°	I	X	I	I
Acrylonitrile	70°	A	A	B	I
Allyl Alcohol	70°	X	X	X	X
Allyl Bromide	70°	X	X	X	I
Allyl Chloride	70°	X	X	X	I
Alum	70°	A	A	A	B
Aluminum Acetate	70°	I	I	I	I
Aluminum Chloride	70°	A	A	A	B
Aluminum Hydroxide	70°	A	A	A	I
Aluminum Sulfate	70°	A	A	A	B
Ammonia Cupric Sulfate	70°	I	X	I	I
Ammonia Water	70°	A	A	A	A
Ammonium Chloride	70°	A	A	A	B
Ammonium Hydroxide	70°	B	B	I	B
Ammonium Nitrate	70°	A	A	A	I
Ammonium Phosphate	70°	I	I	I	B
Ammonium Sulfate	70°	A	A	A	B
Ammonium Sulfide	70°	A	A	A	I
Ammonium Sulfite	70°	A	A	A	I
Ammonium Thiosulfate	70°	A	A	A	I
Amyl Acetate	70°	X	X	X	X
Amyl Alcohol	70°	B	B	I	X
Amyl Chloride	70°	X	X	X	X
Amyl Phenol	70°	I	X	X	I
Amyl Phthalate	70°	I	X	I	I
Aniline Oils	70°	X	X	X	I
Animal Grease	70°	A	A	A	I
Animal Oils	70°	A	A	A	X
Aqua Ammonia	70°	I	B	B	I
Aromatic Tar	70°	X	X	X	I
Arsenic Acid	70°	A	A	A	I

70°F (21°F)

Thermoplastic Hose

	Temp. (F°)	Polyurethane Spirathane	PVC Pliovic Plus	TPE Arvac SW	TPR Green Hornet XF
B					
Arsenic Chloride	70°	A	A	I	I
Arsenic Trichloride	70°	A	A	I	I
Asphalt	70°	X	X	X	X
ASTM #1 Oil	70°	A	A	A	X
ASTM #2 Oil	70°	A	A	I	X
ASTM #3 Oil	70°	A	A	B	X
Barium Carbonate	70°	A	A	A	I
Barium Chloride	70°	A	A	A	I
Barium Hydroxide	70°	A	A	A	I
Barium Sulfate	70°	A	A	A	I
Barium Sulfide	70°	A	A	A	I
Benzyl Chloride	70°	I	X	I	I
Benzaldehyde	70°	X	X	X	X
Benzene (Benzol)	70°	X	X	X	X
Benzine (Ligroin)	70°	X	X	X	X
Benzine Solvent (Ligroin)	70°	X	X	X	X
Benzoic Acid	70°	B	A	A	B
Benzoic Aldehyde	70°	I	X	I	I
Benzotrichloride	70°	I	X	I	I
Benzoyl Chloride	70°	I	X	I	I
Benzyl Acetate	70°	I	X	I	I
Benzyl Chloride	70°	I	X	I	I
Bichromate of Soda	70°	I	A	I	I
Black Sulfate Liquor	70°	A	A	A	I
Bleach	70°	A	A	A	B
Brine	70°	A	A	A	B
Bromine	70°	X	X	X	X
Bromo Benzene	70°	I	X	I	X
Bromo Toluene	70°	I	X	I	I
Bromochloromethane	70°	I	X	I	X
Butanol	70°	I	X	I	B
Butyl (Normal) Alcohol	70°	I	X	X	B
Butyl (Secondary) Alcohol	70°	I	X	X	B
Butyl Acetate	70°	X	X	I	X
Butyl Acetoacetate	70°	I	X	I	I
Butyl Acrylate	70°	I	X	I	I
Butyl Alcohol	70°	A	A	A	B
Butyl Benzene	70°	I	X	I	I
Butyl Benzl Phthalate	70°	I	X	I	I
Butyl Bromide	70°	I	X	I	I
Butyl Butyrate	70°	I	X	I	I
Butyl Chloride	70°	I	X	I	I
Butyl Phthalate	70°	I	X	I	X

Spiraflex Hose Chemical Resistance Guide

Rating Scale

A = May be used for Continuous Service **B** = May be used for Intermittent Service
I = Insufficient data contact Customer Service **X** = Do not use

Thermoplastic Hose

	Temp. (F°)	Polyurethane Spirathane	PVC Pliovic Plus	TPE Arvac SW	TPR Green Hornet XF
Butyric Acid	70°	I	X	B	I
C					
Cadmium Acetate	70°	I	A	I	I
Calcium Acetate	70°	I	A	I	I
Calcium Aluminate	70°	I	A	I	I
Calcium Bichromate	70°	I	A	I	I
Calcium Bisulfate	70°	I	A	B	I
Calcium Bisulfite	70°	A	A	A	I
Calcium Carbonate	70°	A	A	A	I
Calcium Chloride	70°	A	A	A	I
Calcium Hydroxide (Caustic Lime)	70°	A	A	A	I
Calcium Hypochlorite	70°	A	A	I	I
Calcium Nitrate	70°	A	A	I	I
Calcium Silicate	70°	A	A	I	I
Calcium Sulfate	70°	A	A	A	I
Calcium Sulfide	70°	A	A	I	I
Calcium Sulfite	70°	A	A	I	I
Carbolic Acid, Phenol	70°	X	X	X	X
Carbon Dioxide	70°	A	A	A	B
Carbon Disulfide	70°	X	X	X	X
Carbon Monoxide	70°	A	A	A	B
Carbon Tetrachloride	70°	X	X	X	X
Carbonic Acid	70°	I	A	A	I
Casinghead Gasoline	70°	I	X	X	X
Caster Oil (Castor Oil)	70°	A	A	A	I
Caustic Potash	70°	A	A	A	A
Caustic Soda	70°	A	A	A	B
Chlorinated Solvents	70°	I	X	I	I
Chlorine (Dry)	70°	A	A	A	B
Chlorine (Wet)	70°	B	X	I	B
Chloroacetone	70°	I	X	I	I
Chlorobenzene	70°	X	X	X	X
Chlorobutane	70°	I	X	I	I
Chloroethylbenzene	70°	I	X	I	I
Chloroform	70°	X	X	X	X
Chloropentane	70°	I	X	I	X
Chlorophenol	70°	I	X	I	I
Chloropropanone	70°	I	X	I	I
Chlorosulfonic Acid	70°	I	B	I	X
Chlorothene	70°	I	X	I	X
Chlorotoluene	70°	X	X	X	X
Chromic Acid	70°	B	B	B	B
Copper Chloride	70°	A	A	A	B
Copper Hydrate	70°	I	A	I	I

70°F (21°F)

Thermoplastic Hose

	Temp. (F°)	Polyurethane Spirathane	PVC Pliovic Plus	TPE Arvac SW	TPR Green Hornet XF
Copper Hydroxide	70°	I	A	I	I
Copper Nitrate	70°	A	A	A	I
Copper Nitrite	70°	A	A	A	I
Copper Sulfate	70°	A	A	A	I
Copper Sulfide	70°	B	A	B	I
Creosol	70°	X	X	X	X
Creosote	70°	X	X	X	X
Crude Oil	70°	B	A	B	X
Cupric Carbonate	70°	I	A	I	I
Cupric Chloride	70°	A	A	I	I
Cupric Nitrate	70°	A	A	I	I
Cupric Nitrite	70°	A	A	I	I
Cupric Sulfate	70°	A	A	A	I
Cyclohexane	70°	X	X	X	X
Cyclohexanol	70°	X	X	X	X
Cyclohexanone	70°	X	X	X	X
Cyclopentane, methyl	70°	I	A	I	I
Cyclopentanol	70°	I	A	I	I
Cyclopentanone	70°	I	A	I	I
D					
D.D.T.	70°	I	A	I	I
D.D.T. in Kerosene	70°	X	X	X	X
Decalin	70°	I	B	I	I
Decanol	70°	I	B	I	I
Decyl Alcohol	70°	I	A	I	I
Decyl Butyl Phthalate	70°	X	X	X	X
Denatured Alcohol	70°	I	A	B	I
Diacetone Alcohol	70°	B	A	B	B
Diamyl Phenol	70°	X	X	X	X
Dibromobenzene	70°	I	X	I	I
Dibutyl Amine	70°	I	X	I	I
Dibutyl Phthalate	70°	X	X	X	X
Dibutyl Sebacate	70°	I	X	I	I
Dicalcium Phosphate	70°	B	A	B	I
Dichlorobenzene	70°	X	X	X	X
Dichlorobutane	70°	I	X	I	I
Dichlorodibromomethane	70°	X	X	X	X
Dichloroethane	70°	I	X	I	I
Dichloroethyl Ether	70°	I	X	I	X
Dichloroethylene	70°	I	X	I	X
Dichlorohexane	70°	I	X	I	X
Dichloromethane	70°	I	X	I	X
Dichloropentane	70°	I	X	I	X
Dichloropropane	70°	I	X	I	X

Air & Multipurpose
 General Purpose
 Heavy Duty
 Push-on

Chemical Transfer

Cleaning Equipment

Food
 Transfer
 Washdown

Marine

Material Handling
 Abrasives
 Bulk Transfer
 Cement & Concrete

Mining

Petroleum
 Aircraft Fueling
 Dispensing
 Dock
 Transfer

Spray

Steam

Vacuum

LPG Delivery

Water
 Discharge
 Suction & Discharge
 Washdown

Welding

Coupling Systems

Equipment

Appendix

Spiraflex Hose Chemical Resistance Guide

Rating Scale

A = May be used for Continuous Service **B** = May be used for Intermittent Service
I = Insufficient data, contact Customer Service **X** = Do not use

Thermoplastic Hose

	Temp. (F°)	Polyurethane Spirathane	PVC Pliovic Plus	TPE Arvac SW	TPR Green Hornet XF
Diesel Oil	70°	I	B	X	X
Diethylamine	70°	I	I	I	I
Diethyl Benzene	70°	I	X	I	X
Diethyl Ketone	70°	I	X	I	I
Diethyl Oxalate	70°	I	X	I	I
Diethyl Phthalate	70°	I	X	I	I
Diethyl Sebacate	70°	I	X	I	I
Diethylene Glycol	70°	I	B	I	I
Diisobutyl Ketone	70°	I	X	I	I
Diisooctyl Adipate	70°	I	X	I	I
Diisooctyl Phthalate	70°	I	X	I	I
Diisodecyl Adipate	70°	I	X	I	I
Diisopropyl Amine	70°	I	X	I	I
Diisopropyl Ketone	70°	I	X	I	I
Dimethyl Amine	70°	I	X	I	I
Dimethyl Benzene	70°	I	X	I	I
Dimethyl Ketone	70°	I	X	I	I
Dimethyl Phthalate	70°	I	X	I	I
Dinitrobenzene	70°	I	X	I	I
Dioctyl Adipate	70°	I	X	I	I
Dioctyl Phthalate	70°	X	X	X	X
Dioctyl Sebacate	70°	I	X	I	I
Diphenyl Phthalate	70°	I	X	I	I
Dipropyl Ketone	70°	I	X	I	I
Disodium Phosphate	70°	A	A	A	B
Divinyl Benzene	70°	I	X	I	I
Dodecyl Benzene	70°	I	X	I	I
E					
Ethanol	70°	A	A	A	A
Ethanol Amine	70°	B	A	B	I
Ethyl Acetate	70°	X	X	X	B
Ethyl Acetoacetate	70°	I	X	I	I
Ethyl Acrylate	70°	X	X	X	I
Ethyl Alcohol	70°	A	A	A	A
Ethyl Benzene	70°	I	X	I	X
Ethyl Butanol	70°	I	A	I	I
Ethyl Butyl Acetate	70°	I	X	I	I
Ethyl Butyl Alcohol	70°	I	A	I	I
Ethyl Butyl Ketone	70°	I	X	I	I
Ethyl Chloride	---	X	X	X	X
Ethyl Dichloride	70°	X	X	X	X
Ethyl Ether	---	X	X	X	X
Ethyl Formate	70°	I	X	I	I
Ethyl Hexyl Acetate	70°	I	X	I	I

Thermoplastic Hose

	Temp. (F°)	Polyurethane Spirathane	PVC Pliovic Plus	TPE Arvac SW	TPR Green Hornet XF
Ethyl Hexyl Alcohol	70°	I	A	I	I
Ethyl Iodide	70°	X	X	X	X
Ethyl Isobutyl Ether	70°	I	X	I	I
Ethyl Methyl Ketone	70°	X	X	X	X
Ethyl Oxalate	70°	I	X	I	I
Ethyl Phthalate	70°	I	X	I	I
Ethyl Propyl Ether	70°	I	X	I	I
Ethyl Propyl Ketone	70°	X	X	X	I
Ethylene Bromide	70°	X	X	X	X
Ethylene Chloride	70°	X	X	X	X
Ethylene Dibromide	70°	X	X	X	X
Ethylene Dichloride	70°	X	X	X	X
Ethylene Glycol	70°	A	A	A	A
F					
Ferric Bromide	70°	A	A	A	B
Ferric Chloride	70°	A	A	A	A
Ferric Sulfate	70°	A	A	A	A
Ferrous Acetate	70°	A	A	A	I
Ferrous Chloride	70°	A	A	A	B
Ferrous Hydroxide	70°	I	A	A	I
Ferrous Sulfate	70°	A	A	A	A
Fluorine	70°	X	X	X	X
Fluosilicic Acid	70°	A	A	A	B
Formaldehyde	70°	X	X	B	A
Formalin	70°	I	I	A	A
Formic Acid (less than 50%)	70°	B	B	A	A
Formic Acid (more than 50%)	70°	B	X	X	B
Freon* 12	70°	B	B	B	X
Freon* 22	70°	X	X	X	X
Fuel A (ASTM)	70°	A	B	B	I
Fuel B (ASTM)	70°	A	B	X	X
Fuel Oil	70°	A	B	B	X
Furfural	70°	X	X	X	X
G					
Gasoline	70°	X	X	X	X
Glacial Acetic Acid	70°	X	B	I	I
Glycerin	70°	A	A	A	B
Grease	70°	A	A	A	B
H					
Heptane	70°	A	A	X	X
Hexane	70°	A	A	B	X
Hexanol	70°	B	A	B	B

* Freon® is a registered trademark of E.I. du Pont de Nemours and Company. 70°F (21°F)

Air & Multipurpose
 General Purpose
 Heavy Duty
 Push-on

Chemical Transfer

Cleaning Equipment

Food
 Transfer
 Washdown

Marine

Material Handling
 Abrasives
 Bulk Transfer
 Cement & Concrete

Mining

Petroleum
 Aircraft Fueling
 Dispensing
 Dock
 Transfer

Spray

Steam

Vacuum

LPG Delivery

Water
 Discharge
 Suction & Discharge
 Washdown

Welding

Coupling Systems

Equipment

Appendix

Spiraflex Hose Chemical Resistance Guide

Rating Scale

A = May be used for Continuous Service **B** = May be used for Intermittent Service
I = Insufficient data, contact Customer Service **X** = Do not use

Thermoplastic Hose

	Temp. (F°)	Polyurethane Spirathane	PVC Pliovic Plus	TPE Arvac SW	TPR Green Hornet XF
Hexyl Methyl Ketone	70°	I	X	I	I
Hexylene Glycol	70°	I	B	I	I
Hexyl-Alcohol	70°	I	A	I	I
Hydrobromic Acid	70°	A	A	B	B
Hydrochloric Acid	70°	A	B	A	A
Hydrofluoric Acid	70°	A	B	A	B
Hydrofluosilicic Acid	70°	B	B	I	I
Hydrogen Dioxide 10%	70°	I	A	A	I
Hydrogen Dioxide (over 10%)	70°	I	A	A	I
Hydrogen Gas	70°	X	X	X	B
Hydrogen Peroxide 10%	70°	A	A	A	B
Hydrogen Peroxide (over 10%)	70°	A	A	A	B
I					
Iodine	70°	X	X	X	X
Iron Acetate	70°	I	A	I	I
Iron Hydroxide	70°	I	A	A	I
Iron Salts	70°	I	A	A	B
Iron Sulfate	70°	I	A	A	A
Iron Sulfide	70°	I	A	I	I
Isoamyl Acetate	70°	I	X	I	I
Isoamyl Alcohol	70°	I	A	I	I
Isoamyl Bromide	70°	X	X	X	I
Isoamyl Butyrate	70°	I	X	I	I
Isoamyl Chloride	70°	I	X	I	I
Isoamyl Ether	70°	I	X	I	I
Isoamyl Phthalate	70°	I	X	I	I
Isobutanol	70°	I	A	I	A
Isobutyl Acetate	70°	I	X	I	I
Isobutyl Alcohol	70°	I	A	I	A
Isooctane	70°	I	B	X	I
Isopentane	---	I	B	I	I
Isopropanol	70°	I	A	I	A
Isopropyl Acetate	70°	X	X	X	I
Isopropyl Alcohol	70°	A	A	B	B
Isopropyl Benzene	70°	I	X	I	X
Isopropyl Chloride	---	I	X	I	I
J					
Jet Fuels	---	X	X	X	X
K					
Kerosene	70°	X	B	X	X
Ketones	70°	X	X	X	X
L					
Lead Acetate	70°	A	A	A	B

70°F (21°F)

Thermoplastic Hose

	Temp. (F°)	Polyurethane Spirathane	PVC Pliovic Plus	TPE Arvac SW	TPR Green Hornet XF
Lead Sulfate	70°	I	X	I	I
Linseed Oil	70°	A	A	A	X
Lubricating Oils	70°	A	B	B	I
M					
MIBK	70°	I	X	I	X
M.E.K.	70°	X	X	B	X
Magnesium Acetate	70°	I	A	I	I
Magnesium Chloride	70°	A	A	A	A
Magnesium Hydrate	70°	I	A	A	B
Magnesium Hydroxide	70°	A	A	A	A
Magnesium Sulfate	70°	A	A	A	A
Malic Acid	70°	B	A	B	B
Manganese Sulfate	70°	I	A	I	I
Manganese Sulfide	70°	I	A	I	I
Manganese Sulfite	70°	I	A	I	I
Methanol	70°	A	A	A	A
Methyl Alcohol	70°	I	A	I	I
Methyl (Wood) Alcohol	70°	B	B	A	A
Methyl Acetate	70°	X	X	X	X
Methyl Acetoacetate	70°	I	X	I	I
Methyl Acetone	70°	I	X	I	X
Methyl Amyl Acetate	70°	X	X	X	X
Methyl Amyl Alcohol	70°	I	A	I	I
Methyl Amyl Ketone	70°	I	X	A	I
Methyl Benzene	70°	I	X	I	X
Methyl Butanol	70°	I	B	I	X
Methyl Butyl Ketone	70°	I	X	I	I
Methyl Cellosolve	70°	I	B	I	I
Methyl Chloride	---	X	X	X	X
Methyl Ethyl Ketone	70°	X	X	X	X
Methyl Hexyl Ketone	70°	X	X	X	X
Methyl Isobutyl Ketone	70°	X	X	X	X
Methyl Isopropyl Ketone	70°	X	X	X	X
Methyl Normal Amyl Ketone	70°	X	X	X	X
Methylallyl Chloride	70°	X	X	X	X
Methyl Propyl Ether	70°	I	I	A	I
Methyl Propyl Ketone	70°	I	X	I	I
Methylallyl Acetate	70°	I	X	I	I
Methylene Bromide	70°	X	X	X	I
Methylene Chloride	---	X	X	X	X
Mineral Spirits	70°	I	B	I	I
Monochlorobenzene	70°	X	X	X	X
Monochlorodibromomethane	70°	I	X	I	I
Muriatic Acid	70°	I	B	A	B

Air & Multipurpose
 General Purpose
 Heavy Duty
 Push-on

Chemical Transfer

Cleaning Equipment

Food
 Transfer
 Washdown

Marine

Material Handling
 Abrasives
 Bulk Transfer
 Cement & Concrete

Mining

Petroleum
 Aircraft Fueling
 Dispensing
 Dock
 Transfer

Spray

Steam

Vacuum

LPG Delivery

Water
 Discharge
 Suction & Discharge
 Washdown

Welding

Coupling Systems

Equipment

Appendix

Spiraflex Hose Chemical Resistance Guide

Rating Scale

A = May be used for Continuous Service **B** = May be used for Intermittent Service
I = Insufficient data, contact Customer Service **X** = Do not use

Thermoplastic Hose

	Temp. (F°)	Polyurethane Spirathane	PVC Pliovic Plus	TPE Arvac SW	TPR Green Hornet XF
N					
Naphtha	70°	B	B	B	X
Naphthalene	70°	B	X	B	X
Natural Gas	No Hose is recommended for this service				
Nickel Chloride	70°	A	A	A	B
Nickel Nitrate	70°	A	A	A	B
Nickel Sulfate	70°	A	A	A	A
Nitric Acid 10%	70°	A	A	A	B
Nitric Acid 20%	70°	A	B	A	B
Nitric Acid 30%	70°	B	B	A	B
Nitric Acid 30-70%	70°	X	X	X	X
Nitro Benzene	70°	X	X	X	X
Nitrogen Gas	70°	A	A	A	A
Nitrous Oxide	70°	A	A	A	B
O					
Octanol	70°	I	A	I	B
Octyl Acetate	70°	I	X	I	I
Oil Petroleum	70°	A	B	A	I
Oleic Acid	70°	B	B	B	B
Oleum	70°	X	X	X	X
Orthodichlorobenzene	70°	I	X	I	I
Orthodichlorobenzol	70°	I	X	I	I
Oxalic Acid	70°	A	A	A	A
Oxygen	No Hose is recommended for this service				
Ozone	70°	B	B	B	B
P					
Palmitic Acid	70°	B	B	B	B
Papermakers Alum	70°	I	A	I	I
Paradichlorobenzol	70°	I	X	I	I
Paraffin	70°	B	A	B	I
Pentachloroethane	70°	I	I	X	I
Pentane	70°	B	B	I	X
Pentanol	70°	I	A	I	I
Perchloroethylene	70°	X	X	X	X
Petroleum Ether (Ligroin)	70°	A	B	I	X
Petroleum - Crude	70°	A	B	X	X
Petroleum Oils	70°	A	B	X	X
Phenol	70°	X	X	X	X
Phenolsulfonic Acid	70°	I	X	I	I
Phenyl Chloride	70°	I	I	X	X
Phosphoric Acid 10%	70°	A	A	A	A
Phosphoric Acid 10%-85%	70°	B	B	A	B
Polyethylene Glycol	70°	B	B	A	B

70°F (21°F)

Thermoplastic Hose

	Temp. (F°)	Polyurethane Spirathane	PVC Pliovic Plus	TPE Arvac SW	TPR Green Hornet XF
Propylene Glycol	70°	B	B	A	B
Potassium Acetate	70°	I	A	A	B
Potassium Bisulfate	70°	A	A	A	B
Potassium Bisulfite	70°	A	A	A	B
Potassium Carbonate	70°	A	A	A	A
Potassium Chloride	70°	A	A	A	A
Potassium Chromate	70°	A	A	A	B
Potassium Dichromate	70°	A	A	A	B
Potassium Hydrate	70°	I	A	I	B
Potassium Hydroxide	70°	B	A	A	B
Potassium Nitrate	70°	A	A	A	B
Potassium Silicate	70°	I	A	I	B
Potassium Sulfate	70°	A	A	A	B
Potassium Sulfide	70°	A	A	A	B
Potassium Sulfite	70°	A	A	A	B
Propanediol	70°	I	A	I	B
Propanol	70°	I	A	I	B
Propyl Acetate	70°	I	X	I	I
Propyl Alcohol	70°	A	A	B	B
Propyl Chloride	---	X	X	X	X
Propylene Dichloride	70°	X	X	X	X
Propylene Glycol	70°	A	I	A	A
S					
Sea Water	70°	A	A	A	A
Silicate of Soda	70°	I	B	A	A
Soda Ash	70°	A	A	A	A
Soda, Caustic	70°	A	B	A	A
Soda, Lime	70°	I	B	A	I
Soda, Niter	70°	I	B	I	A
Sodium Acetate	70°	A	B	A	B
Sodium Aluminate	70°	I	A	A	B
Sodium Bisulfate	70°	A	A	A	A
Sodium Bisulfite	70°	I	A	A	A
Sodium Carbonate	70°	A	A	A	A
Sodium Chloride (brine)	70°	A	A	A	A
Sodium Chromate	70°	I	A	I	I
Sodium Dichromate	70°	A	A	A	B
Sodium Hydrate	70°	I	A	I	I
Sodium Hydrochlorite	70°	A	A	B	B
Sodium Hydroxide	70°	A	A	A	A
Sodium Hypochlorite	70°	A	A	A	A
Sodium Nitrate	70°	A	A	A	A
Sodium Silicate	70°	A	A	A	A
Sodium Sulfate	70°	A	A	A	A
Sodium Sulfide	70°	A	A	A	A

Air & Multipurpose
 General Purpose
 Heavy Duty
 Push-on

Chemical Transfer

Cleaning Equipment

Food
 Transfer
 Washdown

Marine

Material Handling
 Abrasives
 Bulk Transfer
 Cement & Concrete

Mining

Petroleum
 Aircraft Fueling
 Dispensing
 Dock
 Transfer

Spray

Steam

Vacuum

LPG Delivery

Water
 Discharge
 Suction & Discharge
 Washdown

Welding

Coupling Systems

Equipment

Appendix

Spiraflex Hose Chemical Resistance Guide

Rating Scale

A = May be used for Continuous Service **B** = May be used for Intermittent Service
I = Insufficient data, contact Customer Service **X** = Do not use

Thermoplastic Hose

	Temp. (F°)	Polyurethane Spirathane	PVC Pliovic Plus	TPE Arvac SW	TPR Green Hornet XF
Sodium Sulfite	70°	A	A	A	A
Sodium Thiosulfate	70°	A	A	A	A
Stannic Chloride	70°	A	A	A	B
Stannic Sulfide	70°	I	A	I	I
Stannous Chloride	70°	I	A	I	I
Stannous Sulfide	70°	I	A	I	I
Stearic Acid	70°	A	A	A	A
Sulfonic Acid	70°	I	B	I	I
Sulfur Dioxide (Liquid)	70°	X	X	X	X
Sulfuric Acid (Dry)	70°	A	A	A	A
Sulfuric Acid 25%	70°	A	A	A	A
Sulfuric Acid 25-50%	70°	A	A	A	A
Sulfuric Acid 50-96%	70°	X	X	B	B
Sulfuric Acid Fuming	70°	X	X	X	X
Sulfurous Acid 10%	70°	B	B	B	A
Sulfurous Acid 10-75%	70°	X	X	X	X
T					
Tannic Acid	70°	B	B	B	A
Tar	---	I	X	I	I
Tartaric Acid	70°	A	A	A	A
Tertiary Butyl Alcohol	70°	B	B	B	I
Tetrachlorobenzene	70°	I	X	I	I
Tetrachloroethane	70°	I	X	X	X
Tetrachloroethylene	70°	I	X	X	X
Tetraethylene Glycol	70°	I	B	I	I
Tetrachloromethane	70°	I	X	I	X
Tetrachloronaphthalene	70°	I	X	I	X
Tetrahydrofuran	70°	X	X	X	X
Tin Chloride	70°	B	B	B	B
Tin Tetrachloride	70°	B	B	B	B
THF	70°	I	X	I	X
Toluene	70°	X	X	X	X
Toluidine	70°	I	X	I	I
Toluol	70°	X	X	X	X
Transmission Oil "A"	70°	A	B	I	I
Tributyl Phosphate	70°	X	X	X	X
Trichlorobenzene	70°	X	X	X	X
Trichloroethane	70°	I	X	X	X
Trichloroethylene	70°	X	X	X	X
Trichloropropane	70°	I	I	X	X
Triethanolamine	70°	B	B	B	I
Triethylene Glycol	70°	I	B	I	B
Triphenyl Phosphate	70°	B	X	I	I
Trisodium Phosphate	70°	B	B	A	A
Turpentine	70°	B	B	A	X

70°F (21°F)

Thermoplastic Hose

	Temp. (F°)	Polyurethane Spirathane	PVC Pliovic Plus	TPE Arvac SW	TPR Green Hornet XF
U					
Urea	70°	A	A	A	A
Undecanol	70°	I	A	I	I
V					
V.M. & P. Naptha	70°	I	B	I	I
Vinyl Acetate	70°	I	X	I	X
Vinyl Benzene	70°	I	X	I	X
Vinyl Chloride	---	X	X	X	X
W					
Water	70°	A	A	A	A
Wood Alcohol	70°	B	B	B	A
X					
Xylene (Xylo)	70°	X	X	X	X
Xylidine	70°	I	X	I	I
Z					
Zinc Carbonate	70°	I	A	A	B
Zinc Chloride	70°	A	A	A	B
Zinc Chromate	70°	A	A	A	I
Zinc Sulfate	70°	A	A	A	B

Air & Multipurpose
 General Purpose
 Heavy Duty
 Push-on

Chemical Transfer

Cleaning Equipment

Food
 Transfer
 Washdown

Marine

Material Handling
 Abrasives
 Bulk Transfer
 Cement & Concrete

Mining

Petroleum
 Aircraft Fueling
 Dispensing
 Dock
 Transfer

Spray

Steam

Vacuum

LPG Delivery

Water
 Discharge
 Suction & Discharge
 Washdown

Welding

Coupling Systems

Equipment

Appendix

General Information

Air & Multipurpose

General Purpose

Heavy Duty

Push-on

Chemical Transfer

Cleaning Equipment

Food

Transfer

Washdown

Marine

Material Handling

Abrasives

Bulk Transfer

Cement & Concrete

Mining

Petroleum

Aircraft Fueling

Dispensing

Dock

Transfer

Spray

Steam

Vacuum

LPG Delivery

Water

Discharge

Suction & Discharge

Washdown

Welding

Coupling Systems

Equipment

Appendix

Chemical Properties Of Fluoroethylenepropylene (FEP)

As stated by E.I. du Pont de Nemours

FEP fluorocarbon resins are attacked by certain halogenated complexes containing fluorine including: chlorine trifluoride, bromine trifluoride, iodine pentafluoride and fluorine itself.

FEP is also attacked by such metals as sodium or potassium, especially in their molten states. Great care should be used when mixing finely divided fluorocarbon polymers with finely divided metals, such as aluminum, magnesium or barium, since these can react violently if ignited or heated to a high temperature. Certain complexes of these metals with ammonia or naphthalene (in either solvent) also attack the products. Certain metal hydrides such as boranes, aluminum chloride and certain amines have also been observed to attack fluorocarbon resins at elevated temperatures.

The following materials are inert to FEP:

- › Alcohols
- › Aldehydes
- › Aliphatic Hydrocarbons
- › Anhydrides
- › Aromatics
- › Chlorocarbons
- › Esters
- › Ethers
- › Fluorocarbons
- › Inorganic Bases
- › Inorganic Oxidizing Agents
- › Ketones
- › Organic Acids
- › Salt Solutions
- › Strong Mineral Acids

FEP is a registered trademark with E.I. du Pont de Nemours.

Method For Steam Cleaning Continental ContiTech Products (Chem One™, Viper™, Fabchem™ and Fabchem™ Arc)

5 Important Requirements:

- 1) Hose must be open-ended during steam cleaning.
- 2) Temperature of Steam - Maximum 288°F (142°C).
- 3) Length of Cleaning Time - 5 to 10 minutes...Not more than 15 minutes.
- 4) Care must be taken not to score the tube (liner) with the nozzle or wand end.
- 5) Prolonged steam jet contact on a specific area of the tube (liner) could cause tube damage.

General Information

Infinity™/Paladin® Drop Hose Coupling Procedure

With Insta-Lock™ Fittings

To make an electrically continuous (EC) assembly, the static wire must be terminated to the couplings as the static dissipating property of the tube alone is not sufficient to meet NAHAD¹ or RMA² specifications.

Infinity™

Locate and pull on the static wire between the fabric plies, bend approximately one inch of the static wire under the tube to make contact with the coupling stem. Grounding staple is also an acceptable method.

Paladin®

Locate the static wire between the fabric plies. Insert one leg of a grounding staple in the middle of the wire. Ensure that the other leg of the grounding staple is in contact with the coupling stem.

Attachment Options

Crimp Sleeve—Refer to the Continental ContiTech Products Crimp Assembly Manual for crimp specifications. Current Crimp Sleeve options are listed on page 276 of this catalog. The use of PVC banding coil is not required with crimp sleeve.

Band Clamps—PVC banding coils are required when using this method of attachment. Order the appropriate banding coil to match your hose selection. Follow the procedures below when using the banding coils:

1. Insert stem inside hose end.
2. Apply sufficient banding coil in between the hose outer PVC helix to insure complete coverage under the band clamps position.
3. Place the banding coil tightly around the hose to properly fill the cover depressions. Clamp the first band, re-tighten the banding coil and clamp the second band.
4. Please refer to the NAHAD guidelines for detailed instructions.

Banding coil selection

- › For 2" I.D. hose use 2" I.D. banding coil.
- › For 3" I.D. hose use 3" I.D. banding coil.
- › For 4" I.D. hose use 4" I.D. banding coil.

¹ NAHAD (National Association of Hose and Accessories Distributors)

² RMA (Rubber Manufacturers Association)

Air & Multipurpose

General Purpose
Heavy Duty
Push-on

Chemical Transfer

Cleaning Equipment

Food

Transfer
Washdown

Marine

Material Handling

Abrasives
Bulk Transfer
Cement & Concrete

Mining

Petroleum

Aircraft Fueling
Dispensing
Dock
Transfer

Spray

Steam

Vacuum

LPG Delivery

Water

Discharge
Suction & Discharge
Washdown

Welding

Coupling Systems

Equipment

Appendix

General Information

Basic Hose Construction

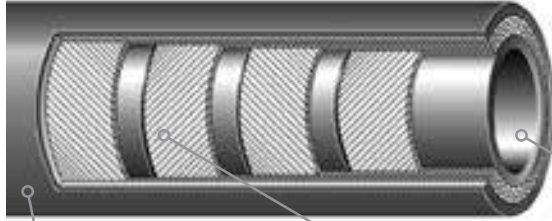

Cover The cover is the outermost or visible area of the hose. It is designed to be a protective covering against wear, abrasion, cuts, weather, and the general destructive action encountered in normal service.

Body or Carcass The body reinforcement is the supporting structure of the hose. It can range from simple to complex combinations and consists of cord, yarn, fabric, wire, or any combination of these.

Tube Or Lining The tube is the inner-most element of a hose and is compounded to provide resistance to the material being carried. With the wide range of rubber compounds available, a hose can be built to withstand abrasive materials, chemicals, oil and a wide variety of other materials.

The Four Basic Methods Of Hose Construction

Although we make more than 2,000 types of hose for specialized applications, there are only four basic construction methods used. Since each of these four methods embodies certain fundamental characteristics that make it particularly suitable for certain functions, an understanding of these methods may assist you in making the best use of this catalog. Keep in mind that a reference to any one of these types of construction will imply all the characteristics and benefits outlined here plus specific features attained through the proper compounding of rubber, choice materials, and variation in plies and thickness to ensure that each hose is exactly right for the job for which it is designed.

Type 1

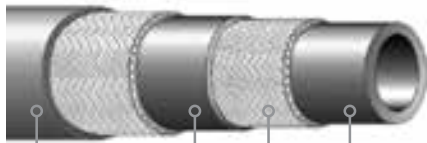

D C B A

Type 1: Vertical Braided Hose

- Entire hose length cured in one operation.
- A. Extruded seamless tube.
- B. Seamless reinforcing braids of synthetic textile wire or other material – applied by high speed vertical or horizontal braiders.
- C. Rubber layers between braids establish positive bond between braids when vulcanized.
- D. Extruded, seamless cover.

Type 2

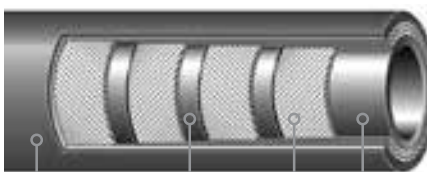

D C B A

Type 2: Spiral Hose

- Built by machine with either textile or wire cord reinforcement applied so that each ply is laid at a given angle for maximum dimensional stability.
- A. Extruded or calendered tube.
- B. Reinforcement of synthetic textile wire or other material.
- C. Rubber layers between reinforcement plies to establish positive bond.
- D. Cover.

Air & Multipurpose
General Purpose
Heavy Duty
Push-on

Chemical Transfer

Cleaning Equipment

Food
Transfer
Washdown

Marine

Material Handling
Abrasives
Bulk Transfer
Cement & Concrete

Mining

Petroleum
Aircraft Fueling
Dispensing
Dock
Transfer

Spray

Steam

Vacuum

LPG Delivery

Water
Discharge
Suction & Discharge
Washdown

Welding

Coupling Systems

Equipment

Appendix

General Information

The Four Basic Methods of Hose Construction (continued)

Type 3

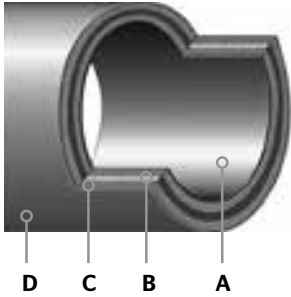

Type 3: Hand-built Spiral-plied Hose

Built by hand on a mandrel. Cured under pressure applied from outside by cloth wraps and steam.

- A. Calendered, or "built-up" tube to fit service.
- B. Tailor-made spiral-wrapped fabric.
- C. Wire reinforcement where needed.
- D. Cover stock of selected gauge and compound. Wrap cured.

Type 4

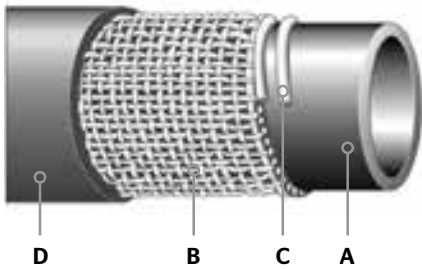

Type 4: Knitted Hose

- A. Extruded seamless tube.
- B. Seamless woven textile jacket.
- C. Interwoven wire helix reinforcement where needed.
- D. Extruded seamless cover.

Advantages

TYPE 1 Braided Hose

Flexible, high resistance to kinking. Cover either smooth or wrapped. Available in long continuous lengths. Excellent tensile strength.

TYPE 2 Spiral Hose

Extremely flexible. Smooth bore, uniform tube. High strength with long length capability.

TYPE 3 Hand-built Spiral-plied Hose

Craftsman-built to special requirements. Wide variation in sizes, constructions and materials. Built-in strength to fit most rugged job requirements. Couplings, fittings, nipples, flanges and beaded ends can be built in. Available in lengths up to 50 feet, in sizes up to 18 inches. On larger diameters, consult your Continental ContiTech representative.

Air & Multipurpose
General Purpose
Heavy Duty
Push-on

Chemical Transfer

Cleaning Equipment

Food
Transfer
Washdown

Marine

Material Handling
Abrasives
Bulk Transfer
Cement & Concrete

Mining

Petroleum
Aircraft Fueling
Dispensing
Dock
Transfer

Spray

Steam

Vacuum

LPG Delivery

Water
Discharge
Suction & Discharge
Washdown

Welding

Coupling Systems

Equipment

Appendix

General Information

Definitions of Hose Ends

Air & Multipurpose

- General Purpose
- Heavy Duty
- Push-on

Chemical Transfer

Cleaning Equipment

- Food**
- Transfer
- Washdown

Marine

Material Handling

- Abrasives
- Bulk Transfer
- Cement & Concrete

Mining

Petroleum

- Aircraft Fueling
- Dispensing
- Dock
- Transfer

Spray

Steam

Vacuum

LPG Delivery

Water

- Discharge
- Suction & Discharge
- Washdown

Welding

Coupling Systems

Equipment

Appendix



Plain End

All hose construction elements (including wire, if wire is used as a reinforcing member) are exposed. The hose always has the same inside diameter throughout. In the case of certain hand-built specifications having wire reinforcement, the wire and fabric reinforcement are not exposed. All vertical spiral hose is available only with plain ends. Horizontal spiral and wrapped ply machine-built hose is furnished with plain ends unless otherwise specified in the pricebook.

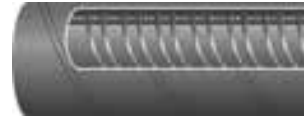

Built-In Nipple End

The hose end is integrally built around and bonded to the nipple body. The hose reinforcing materials are also anchored to the nipple. The nipples used are generally fabricated from pipe. Nipples made from standard pipe will be full bore only when pipe 12" and under is used since nominal pipe sizes over 12" are described by pipe OD and not ID. Available only in hand-built hose constructions.



Swaged End

Primarily used on petroleum OS&D dock hose as an alternative to built-in nipples. The steel (carbon or stainless) stem/coupling accommodates threaded, slip-on or welded flanged ends. Stem/coupling attached to hose with swaged steel ferrule over the cover.



Enlarged End

The hose end is enlarged to accommodate the outside diameter of the shank of a fitting plus the depth of the shank. The helical wire is terminated at the enlarged end. The inside diameter of a "standard" enlarged end is the same dimension as the outside diameter of the same nominal pipe size. (Example-6" ID hose enlarged to 65/8" at the end, handles a 6" size pipe which has a 65/8" OD.) Normally used in hand-built hose constructions.



General Information

Definitions of Hose Ends



Integral Rubber Tapered Nozzle End

The inside diameter and the outside diameter of the hose end are gradually tapered down to form a nozzle. The hose reinforcement is also extended to the end of the nozzle. A rubber end cap is then added to protect the reinforcement and properly shape the nozzle. This type of nozzle is available only in non-wire inserted horizontal spiral and wrapped ply machine-built hose.



Rubber Beaded End

A flared bell shape, molded as an integral part of the hose. The reinforcing fabric of the hose body is extended beyond the straight portion of the hose and anchored around a circular steel reinforcing ring. A reattachable split malleable iron flange is placed behind the rubber bead to act as a metal bearing surface for bolt heads and nuts. Bolts used to connect mating flanges pass over the outside diameter of the zbeaded end. Normally used in hand-built hose constructions.



Integral Rubber Flanged End

Shaped similar to a metal pipe flange. It is molded as an integral part of the hose with the tube, fabric reinforcement (not wire) and cover extending to the outside diameter of the rubber flange. The rubber flange has holes to match customer requirements. In addition, solid metal "backup" rings (drilled to match the rubber flange holes) are always placed behind the rubber flange to provide a metal bearing surface for bolt heads and nuts. Available only in hand-built hose constructions.



Soft End

The helical wire reinforcement is terminated several inches back from the end of the hose. When a hose has either a corrugated cover or tube or both, a soft end is generally used and always has a smooth inside diameter and outside diameter. Normally used in hand-built hose constructions.



Air & Multipurpose
General Purpose
Heavy Duty
Push-on

Chemical Transfer

Cleaning Equipment

Food
Transfer
Washdown

Marine

Material Handling
Abrasives
Bulk Transfer
Cement & Concrete

Mining

Petroleum
Aircraft Fueling
Dispensing
Dock
Transfer

Spray

Steam

Vacuum

LPG Delivery

Water
Discharge
Suction & Discharge
Washdown

Welding

Coupling Systems

Equipment

Appendix

General Information

Air & Multipurpose

General Purpose
Heavy Duty
Push-on

Chemical Transfer

Cleaning Equipment

Food
Transfer
Washdown

Marine

Material Handling
Abrasives
Bulk Transfer
Cement & Concrete

Mining

Petroleum
Aircraft Fueling
Dispensing
Dock
Transfer

Spray

Steam

Vacuum

LPG Delivery

Water
Discharge
Suction & Discharge
Washdown

Welding

Coupling Systems

Equipment

Appendix

Hose Testing Methods

Reprinted from RMA hose handbook IP-2 2003

Safety Warning

Testing can be dangerous and should be done only by trained personnel using proper tools and procedures. Failure to follow such procedures might result in damage to property and/or serious bodily injury.

The Rubber Manufacturers Association (RMA) recognizes, accepts and recommends the testing methods of the American Society for Testing and Materials (ASTM).

Unless otherwise specified, all hose tests are to be conducted in accordance with ASTM Method No. D-380 (latest revision). Where an ASTM D-380 test is not available, another test method should be selected and described in detail.

RMA participates with ASTM under the auspices of the American National Standards Institute (ANSI) in Technical Committee 45 (TC45) of The International Organization for Standardization (ISO) in developing both hose product and hose test method standards. Many of the hose test method standards published by ISO duplicate or closely parallel those shown in ASTM D-380. Many are unique and, in those cases, the RMA may be able to provide the necessary test standard references which may be purchased from the ANSI.

Hydrostatic Pressure Tests

Hydrostatic pressure tests are classified as follows:

1. Destructive Type

- a. Burst test b. Hold test

Destructive Tests

Destructive tests are conducted on short specimens of hose, normally 18 inches (460mm) to 36 inches (915mm) in length and, as the name implies, the hose is destroyed in the performance of the test.

- a. Burst pressure is recorded as the pressure at which actual rupture of a hose occurs.
b. A hold test, when required, is a means of determining whether weakness will develop under a given pressure for a specified period of time.

2. Non-Destructive Type

- | | | | |
|---|--|---------------|------------------------------|
| a. Proof pressure test | c. Change in outside diameter
or circumference test | e. Rise test | h. Volumetric expansion test |
| b. Change in length test
(elongation or contraction) | d. Warp test | f. Twist test | g. Kink test |

Non-Destructive Tests

Non-destructive tests are conducted on a full length of a hose or hose assembly. These tests are for the purpose of eliminating hose with defects which cannot be seen by visual examination or in order to determine certain characteristics of the hose while it is under internal pressure.

- a. A **proof pressure test** is normally applied to hose for a specified period of time. On new hose, the proof pressure is usually 50% of the minimum specified burst except for woven jacket fire hose where the proof pressure is twice the service test pressure marked on the hose (67% of specified minimum burst). Hydrostatic tests performed on fire hose in service should be no higher than the service test pressure referred to above. The regulation of these pressures is extremely important so that no deteriorating stresses will be applied, thus weakening a normal hose.
- b. With some type of hose, it is useful to know how a hose will act under pressure. All change in length tests, except when performed on wire braid or wire spiralled hose, are made with original length measurements taken under a pressure of 10 psi (0.069 MPa). The specified pressure, which is normally the proof pressure, is applied and immediate measurement of the characteristics desired are taken and recorded.

General Information

Hose Testing Methods Hydrostatic Pressure Tests (continued)

Percent length change (elongation or contraction) is the difference between the length at 10 psi (0.069 MPa) (except wire braided or wire spiralled) and that at the proof pressure times 100 divided by the length at 10 psi (0.069 MPa). Elongation occurs if the length of the hose under the proof pressure is greater than at a pressure of 10 psi (0.069 MPa). Contraction occurs if the length at the proof pressure is less than at 10 psi (0.069 MPa). In testing wire braided or spiralled hose, the proof pressure is applied and the length recorded. The pressure is then released and, at the end of 30 seconds, the length is measured; the measurement obtained is termed the "original length."

- c. Percent change in outside diameter or circumference** is the difference between the outside diameter or circumference at 10 psi (0.069 MPa) and that obtained under the proof pressure times 100 divided by the outside diameter or circumference at 10 psi (0.069 MPa). Expansion occurs if the measurement at the proof pressure is greater than at 10 psi (0.069 MPa). Contraction occurs if the measurement at the proof pressure is less than at 10 psi (0.069 MPa).
- d. Warp** is the deviation from a straight line drawn from fitting to fitting; the maximum deviation from this line is warp. First, a measurement is taken at 10 psi (0.069 MPa) and then again at the proof pressure. The difference between the two, in inches, is the warp. Normally this is a feature measured on woven jacket fire hose only.
- e. Rise** is a measure of the height a hose rises from the surface of the test table while under pressure. The difference between the rise at 10 psi (0.069 MPa) and at the proof pressure is reported to the nearest 0.25 inch (6.4 mm). Normally, this is a feature measured on woven jacket fire hose only.
- f. Twist** is a rotation of the free end of the hose while under pressure. A first reading is taken at 10 psi (0.069 MPa) and a second reading at proof pressure. The difference, in degrees, between the 10 psi (0.069 MPa) base and that at the proof pressure is the twist. Twist is reported as right twist (to tighten couplings) or left twist. Standing at the pressure inlet and looking toward the free end of a hose, a clockwise turning is right twist and counterclockwise is left twist.
- g. Kink test** is a measure of the ability of woven jacket hose to withstand a momentary pressure while the hose is bent back sharply on itself at a point approximately 18 inches (457 mm) from one end. Test is made at pressures ranging from 62% of the proof pressure on sizes 3 inches (76 mm) and 3.5 inches (89 mm) to 87% on sizes under 3 inches (76 mm). This is a test applied to woven jacket fire hose only.
- h. Volumetric expansion test** is applicable only to specific types of hose, such as hydraulic or power steering hose, and is a measure of its volumetric expansion under ranges of internal pressure.

Design Considerations

In designing hose, it is customary to develop a design ratio, which is a ratio between the minimum burst and the maximum working pressure.

Burst test data is compiled and the minimum value is established by accepted statistical techniques. This is done as a check on theoretical calculations, based on the strength of reinforcing materials and on the characteristics of the method of fabrication.

Minimum burst values are used as one factor in the establishment of a reasonable and safe maximum working pressure.

Maximum working pressure is one of the essential operating characteristics that a hose user must know and respect to assure satisfactory service and optimum life.

It should be noted that design ratios are dependent on more than the minimum burst. The hose technologist must anticipate natural decay in strength of reinforcing materials, and the accelerated decay induced by the anticipated environments in which the hose will be used and the dynamic situations that a hose might likely encounter in service.

Including all considerations, the following recommended design ratios are given for newly manufactured hose:

1. Water hose up to 150 psi WP: 3:1
2. Hose for all other liquids, solid materials suspended in liquids or air, and water hose over 150 psi WP: 4:1
3. Hose for compressed air and other gases: 4:1
4. Hose for liquid media that immediately changes into gas under standard atmospheric conditions: 5:1
5. Steam hose: 10:1

Air & Multipurpose
General Purpose
Heavy Duty
Push-on

Chemical Transfer

Cleaning Equipment

Food
Transfer
Washdown

Marine

Material Handling
Abrasives
Bulk Transfer
Cement & Concrete

Mining

Petroleum
Aircraft Fueling
Dispensing
Dock
Transfer

Spray

Steam

Vacuum

LPG Delivery

Water
Discharge
Suction & Discharge
Washdown

Welding

Coupling Systems

Equipment

Appendix

General Information

Air & Multipurpose

General Purpose
Heavy Duty
Push-on

Chemical Transfer

Cleaning Equipment

Food
Transfer
Washdown

Marine

Material Handling
Abrasives
Bulk Transfer
Cement & Concrete

Mining

Petroleum
Aircraft Fueling
Dispensing
Dock
Transfer

Spray

Steam

Vacuum

LPG Delivery

Water
Discharge
Suction & Discharge
Washdown

Welding

Coupling Systems

Equipment

Appendix

Electrical Resistance Tests for Hose and Hose Assemblies

1.0 Purpose

This procedure specifies methods for performing electrical resistance tests on rubber and/or plastic hose and hose assemblies.

2.0 Scope

These procedures are intended to test electrical conductive, antistatic and nonconductive (insulating) hoses, along with electrical continuity or discontinuity between fittings.

Warning

Hydraulic hoses used on power and telephone mobile equipment should be tested to SAE 100R8 requirements.

3.0 Definitions

- 3.1 Antistatic Hose - Antistatic hose constructions are those that are capable of dissipating the static electricity buildup that occurs during the high velocity flow of material through a hose.
- 3.2 Conductive Hose - Conductive hose constructions are those that are capable of conducting an electrical current.
- 3.3 Direct Current (DC): Flow of electrical current in one direction at a constant rate.
- 3.4 Electrical Conductivity: A measure of the ease with which a material is capable of conducting an electrical current.
Conductivity = 1/Resistance.
- 3.5 Electrical Resistance: Property of an object to resist or oppose the flow of an electrical current.
- 3.6 Non-Conductive (Insulating) Hose: Non-conductive hose constructions are those that resist the flow of electrical current.
- 3.7 Ohm's Law: The electrical current, I, is equal to the applied voltage, V, divided by the resistance, R. In practical terms, the higher the electrical resistance at a constant voltage, the lower the electrical current flow through an object.
- 3.8 Ohm: The amount of resistance that limits the passage of current to one ampere when a voltage of one volt is applied to it.

4.0 Apparatus

- 4.1 Test Instruments: All test instruments shall have a gauge reliability and reproducibility (R&R) of less than 30%. Some instruments made to measure high electrical resistance may have an internal protection circuit built in which will cause test errors in the less than one megohm range.
During the test, no more than 3 watts (W) shall be dissipated in the specimen, to prevent erroneous results due to effects of temperature. The power dissipated shall be determined by the square of the open-circuit voltage divided by the measured resistance, see formula 1 (Power Dissipation).

$$1) \text{ Power Dissipation} = \frac{(\text{Voltage})^2}{\text{Resistance in ohms}}$$

To determine the electrical resistance of non-conductive hose, the test should be made with an instrument designed specifically for measuring insulation resistance, having a nominal open-circuit voltage of 500 volts D.C., or with any other instrument known to give comparable results. For measuring electrical discontinuity, a 1,000 volt D.C. source may be used instead of a 500 volt D.C. source.

For hoses with a conductive tube or cover, the resistance values obtained may vary with the applied voltage, and errors may occur at low-test voltages. As a starting point, an ohmmeter (9 volts) can be used. For tests requiring measurement of electrical continuity between end fittings or through continuous internal or external bonded wires, the instrument used shall be an ohmmeter (9 volts).

4.2 Electrodes and Contacts: When the test procedure calls for contact with the hose cover, electrodes shall be formed around the outer circumference of the hose as bands 25mm +2mm, 0 mm (1" +1/16", 0") wide by applying silver lacquer/ conductive liquid and metallic copper foil tape (i.e. 3M Scotch Brand) as shown in Figure 6-1. When a conductive silver

General Information

Electrical Resistance Tests for Hose and Hose Assemblies (continued)

lacquer (i.e. Colloidal Silver Liquid is available from Ted Pella, Inc. catalogue # 16031) is used, the surface resistance between any two points on a sample of the dried film shall not exceed 100 Ω . When a conductive liquid is used the electrode contact area shall be completely wetted and shall remain so until the end of the test.

The conductive liquid shall consist of:

- › Anhydrous polyethylene glycol of relative molecular mass 600: 800 parts by mass
- › Water: 200 parts by mass
- › Wetting agent: 1 part by mass
- › Potassium Chloride: 10 parts by mass

When the test procedure calls for contact with the hose tube, it is preferable to use a copper plug of external diameter equal to or slightly greater than the hose ID or a steel hose stem, coated with the conducting liquid, and pushed 25mm (1") into the hose. An alternative for 50mm (2") and above hose would be to apply the conductive silver lacquer onto the hose ID, then insert the plug or hose stem. The electrical leads from the test instrument shall be clean and they should make adequate contact with the metallic copper foil and/or copper plugs/hose stems.

5.0 Preparation and Cleaning for Test

The surfaces of the hose shall be clean. If necessary, the hose surface may be cleaned by rubbing with Fuller's earth (magnesium aluminum silicate) and water, followed by a distilled water rinse, and allowing the hose to dry in a non-contaminating environment. Do not use organic materials that attack or swell the rubber, and do not buff or abrade the test surfaces.

The surface of the hose shall not be deformed either during the application of the contacts or during the test. When using test pieces, the supports shall be outside the test length. When using a long length of hose, the hose shall be uncoiled and laid out straight on polyethylene or other suitable insulating material. Care should be taken to ensure that the hose is insulated from any electrical leakage path along the length of the hose.

6.0 Test Conditions

For lab testing, the hose or hose assemblies shall be conditioned for at least 16 hours at +23° C \pm 2°C (73.4°F \pm 3.6°F) with a relative humidity not to exceed 70%. However, it is permissible, by agreement between the supplier and the customer, to use the conditions prevailing in the factory, warehouse, or laboratory, provided that the relative humidity does not exceed 70%.

7.0 Test Pieces

Prepare three test pieces approximately 300mm (12") long from samples taken at random from a production run or lot. Condition the test pieces per section 6.0.

Place the test piece on blocks of polyethylene, or other insulating material, to provide a resistance of greater than 100 Ω between the test piece and the surface on which the blocks are supported. Ensure that the leads from the instrument do not touch each other, the hose, or any part except the terminal to which each is connected.

Avoid breathing on the test surfaces and thus creating condensation that may lead to inaccuracies.

8.0 Procedure for hoses with conducting tube

Apply the electrodes as specified to the inside surface of the hose at each end of the hose. The edge of the electrode plug shall be coincident with the end of the hose. When using a conductive liquid, care shall be taken to avoid creating a leakage path between the tube and the reinforcement or cover of the hose.

Apply the metal contacts to the electrodes.

Apply the test voltage (9V) and measure the resistance 5 seconds \pm 1 second after the voltage is applied.

Note: In previous editions of the Hose Handbook, this method was referred to as the Plug Method.

9.0 Procedure for hose with conducting cover

Apply the electrodes as specified to the outer circumference of the hose at each hose end. See Figure 6-1.

Ensure that contact is maintained with the electrodes around the circumference and that the contact pieces are sufficiently long enough for the two free ends to be held securely by a tensioning clip (see Figure 6-1) such that the fit of the electrodes is as tight as possible.

Apply the metal contacts.

Apply the test voltage (9V) and measure the resistance 5 seconds \pm 1 second after the voltage is applied.

Air & Multipurpose

General Purpose
Heavy Duty
Push-on

Chemical Transfer

Cleaning Equipment

Food
Transfer
Washdown

Marine

Material Handling
Abrasives
Bulk Transfer
Cement & Concrete

Mining

Petroleum
Aircraft Fueling
Dispensing
Dock
Transfer

Spray

Steam

Vacuum

LPG Delivery

Water
Discharge
Suction & Discharge
Washdown

Welding

Coupling Systems

Equipment

Appendix

General Information

Air & Multipurpose

General Purpose
Heavy Duty
Push-on

Chemical Transfer

Cleaning Equipment

Food
Transfer
Washdown

Marine

Material Handling
Abrasives
Bulk Transfer
Cement & Concrete

Mining

Petroleum
Aircraft Fueling
Dispensing
Dock
Transfer

Spray

Steam

Vacuum

LPG Delivery

Water
Discharge
Suction & Discharge
Washdown

Welding

Coupling Systems

Equipment

Appendix

Electrical Resistance Tests for Hose and Hose Assemblies (continued)

Dimensions in Millimeters

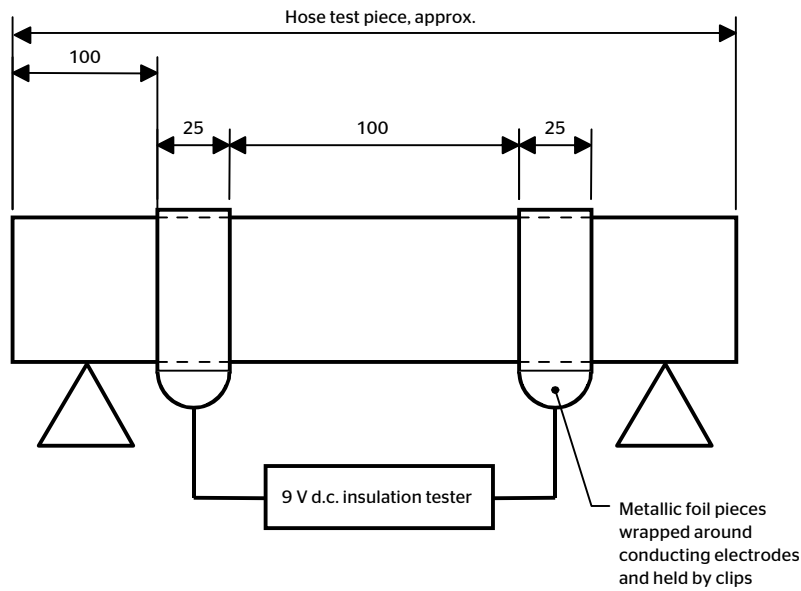

Figure 6-1 - Electrodes and contacts for testing hose

10.0 Procedure for hose with conducting or non-conducting compounds throughout

Apply the electrodes as specified on the inside surface at one end of the hose (end A) and on the outside surface at the other end of the hose (end B).

Apply the metal contacts to the electrodes.

Apply the test voltage (9V for conductive compounds and 500V for non-conductive compounds) and measure the resistance 5 seconds + 1 second after the voltage is applied.

Alternative method for non-conductive hose - Nail or "Pot Room" Method

Conduct test as follows:

1. Cut sample hose, 24 inches long
2. Assure that both inside and outside of hose are free of oil, dirt, etc.
3. Pierce sample ends with clean nails, as shown in Fig. 6-2.
4. Connect nails to 1000-volt DC power source and megohm meter or 1000 volt "megger" as shown in Fig. 6-2.
5. Record total resistance, in megohms.
6. Measure "test length" as shown in Fig. 6-2.
7. Divide total resistance by test length to get megohms per inch.

General Information

Electrical Resistance Tests for Hose and Hose Assemblies (continued)

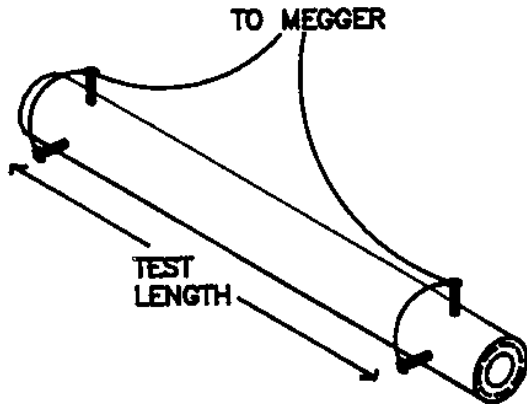

Figure 6-2 - Nail or “Pot Room” Test

11.0 Procedure for hose assemblies fitted with metal end fittings

When it is required that the resistance of a hose assembly be measured, the leads of the test instrument shall be attached directly to the metal hose shank (threaded end connection, fixed flange, stub end of a floating flange, etc.) of the metal end fittings.

Some hoses, especially thermoplastic hoses, have conductive layers within the hose construction. These hoses shall be tested as assemblies made with fittings and assembly techniques specified by the hose and fitting manufacturer.

Apply the metal contacts to the metal end fittings.

Apply the test voltage (9V) and measure the resistance 5 seconds + 1 second after the voltage is applied.

12.0 Procedure for measurement of electrical continuity

In certain types of hose constructions, electrical continuity is provided between the end fittings by means of a continuous wire or wires bonded to each coupling. When the construction is such that there are internal and external wires, the electrical continuity of both wires shall be established.

It is essential that contact resistance between the end fittings and the ohmmeter be minimized.

Apply the metal contacts to the metal end fittings.

Apply the test voltage (9V) and measure the resistance 5 seconds + 1 second after the voltage is applied.

Air & Multipurpose

General Purpose
Heavy Duty
Push-on

Chemical Transfer

Cleaning Equipment

Food
Transfer
Washdown

Marine

Material Handling
Abrasives
Bulk Transfer
Cement & Concrete

Mining

Petroleum
Aircraft Fueling
Dispensing
Dock
Transfer

Spray

Steam

Vacuum

LPG Delivery

Water
Discharge
Suction & Discharge
Washdown

Welding

Coupling Systems

Equipment

Appendix

General Information

Elastomers Used in the Manufacture of “Rubber Type” Products

	Continental ContiTech Tradename	Industry Designation	Outstanding Feature	Sample Hose
Air & Multipurpose General Purpose Heavy Duty Push-on	Alphasyn	Modified Cross-Link Polyethylene	Excellent high-temperature chemical resistance.	Tube compound in Viper chemical transfer hose.
Chemical Transfer	Carbryn	Carboxylated Nitrile	Excellent oil and abrasion resistance, good chemical resistance.	Cover compound on multipurpose hose: Gorilla and Ortac, pressure washer hose: Galvanator and Gauntlet.
Cleaning Equipment	Nitrile	Nitrile or Buna-N	Oil, solvent and aromatics resistance.	Tube and cover compound in premium air and multipurpose hose, petroleum transfer hose: Gorilla, Ortac, Flexwing Petroleum.
Food Transfer Washdown	Chemivic	Nitrile	Oil and abrasion resistant compound. Excellent ozone resistance.	Cover compound air/mp hose. Tube compound in food hose: White Flexwing.
Marine	Chemrin	Chlorinated Polyethylene (CPE)	Excellent chemical resistance.	Tube compound chemical hose: Brown Flexwing.
Material Handling Abrasives Bulk Transfer Cement & Concrete	Chlorobutyl	Chlorobutyl	FDA compliant material in food hose. Excellent heat resistance.	Tube compound in food hose and Flexsteel 250 CB Steam Hose.
Mining	Flosyn	Viton	Excellent oil and chemical resistance.	Tube compound in Orange Flexwing chemical hose.
Petroleum Aircraft Fueling	Hysunite	Hypalon	Chemical and oil resistant.	Tube compound in chemical transfer hose: Yellow Flexwing.
Dispensing Dock Transfer	Nylon	Nylon	Resistant to many paint sprays, lacquers, thinners, and mild chemicals.	Tube compound in NR Paint Spray.
Spray	Omeegasyn	EPDM (abrasion-resistant)	Excellent abrasion resistance. Mild chemical resistance.	Cover compound: Viper.
Steam	SBR	SBR	Good abrasion resistance.	Tube and cover compound in water suction and discharge hose: Plicord Water S&D.
Vacuum	Pyrosyn	EPDM	Heat resistant	Tube compound in Flexsteel 250 Steam and Whitewater, Cover on Flexsteel 250 Steam and Flexsteel 250 CB Steam
LPG Delivery				
Water Discharge Suction & Discharge Washdown				
Welding				
Coupling Systems				
Equipment				

General Information

Elastomers Used in the Manufacture of “Rubber Type” Products

Continental ContiTech Tradename	Industry Designation	Outstanding Feature	Sample Hose
Pliosyn	Ultra High Molecular Weight Polyethylene	Excellent chemical resistance. Good flexibility properties.	Tube compound in Fabchem chemical hose.
Pliovic	Polyvinyl Chloride	Lightweight, flexible and economical.	Pliovic 250, Spiraflex 1600.
Pureten	Natural Rubber	Excellent abrasion resistance, resilient, tensile strength, retains flexibility below 0°F (-18°C) (Poor ozone).	Tube compound in material handling hose: Blucor, Harvest, and Tan Flexwing.
Speclar	Cross-Link Polyethylene	Excellent chemical resistance.	Tube compound in Blue Flexwing chemical hose.
Spirathane	Urethane	Excellent abrasion resistance and good chemical resistance.	Spirathane LD and inner liner of Spirathane HD.
Teflon	Fluorinated Propylene or Teflon	Excellent chemical and petroleum resistance.	Tube compound in Hi-Per Teflon Hose.
TPE	Thermoplastic Elastomer	Heat and/or cold resistant, flexible and resistant to solvents.	Premier.
ChemiTuf Polybutadiene®	Polybutadiene Blend	Good tensile strength, high elongation, abrasion resistance, nonstatic properties.	Tube compound in Plicord Blast, Plicord Dredge Sleeve, Sand Suction
EPDM	EPDM	Heat and/or cold resistant, weather and ozone resistant, mild chemical resistance.	Tube and cover compound in multipurpose hose: Frontier, cover compound on chemical hose: Fabchem.
Weatherex	Butyl	Low permeability to air and gas; outstanding dampening and shock effect.	Tube compound in chemical transfer hose: Yellow Flexwing.
Wingprene	Neoprene (DuPont)	All purpose elastomer; good oil, heat and chemical resistance; very good ozone resistance.	Cover compound in petroleum transfer hose: Super Black Flexwing, and Red Flextra.

Air & Multipurpose

General Purpose
Heavy Duty
Push-on

Chemical Transfer

Cleaning Equipment

Food
Transfer
Washdown

Marine

Material Handling

Abrasives
Bulk Transfer
Cement & Concrete

Mining

Petroleum
Aircraft Fueling
Dispensing
Dock
Transfer

Spray

Steam

Vacuum

LPG Delivery

Water
Discharge
Suction & Discharge
Washdown

Welding

Coupling Systems

Equipment

Appendix

General Information

Air & Multipurpose

General Purpose

Heavy Duty

Push-on

Chemical Transfer

Cleaning Equipment

Food

Transfer

Washdown

Marine

Material Handling

Abrasives

Bulk Transfer

Cement & Concrete

Mining

Petroleum

Aircraft Fueling

Dispensing

Dock

Transfer

Spray

Steam

Vacuum

LPG Delivery

Water

Discharge

Suction & Discharge

Washdown

Welding

Coupling Systems

Equipment

Appendix

How to Select the Right Hose

In order to obtain the best service from any particular hose application, two important conditions must be fulfilled:

1. To select the right hose for the job.
2. To make sure, that after having obtained the right hose, it is fitted correctly and used in a proper manner.

When considering a particular hose application, the following basic factors should be considered:

1. Inside diameter.
2. Outside diameter.
3. Materials being conveyed (e.g., air, water, acids, oils, steam).
4. Precise composition of substance (important in the case of oils, solvents, spraying media, foods, beverages, petroleum products, gases, etc.).
5. Concentration (in the case of chemicals).
6. Maximum temperature of substance.
7. Maximum pressure (including any possible surge or back pressure).
8. Degree of vacuum (in the case of suction hose).
9. External conditions. The scope of this factor is possibly the widest of all and covers such things as:
 - Abrasion
 - Climactic conditions
 - Direct heat
 - Radiated heat
 - Contamination from oil, grease, solvents, acids, etc
 - End loads
 - Flexings – degree and cycle
 - Crushing conditions
 - Kinking conditions
10. Details of couplings (particularly in specialized applications).

Steam Hose

Air, steam and water hoses are the three types of hose most used in industrial plants. The following instructions apply in general to these types of hose. Since steam service is usually the most severe in the average plant, particular attention is directed to steam hose. In selecting a hose for a steam installation it is important that the type recommended is sufficient to handle the maximum working pressure. Your Continental ContiTech representative will assist in making recommendations.

At elevated temperatures, steam severely affects rubber hose of all types, so it is important that temperature be considered in the choice of a steam hose. High steam temperature and pressure can cause deterioration in certain reinforcing

members used in hose and a relatively small increase in temperature can greatly affect hose performance.

The steam pressure is important in that it determines the minimum temperature condition under which the hose will be used. If the steam is saturated, its temperature is directly related to its pressure. The temperature may be determined from the Saturated Steam Table on page 322. However, if steam is superheated, the degree of superheating must be known to determine the actual temperature which the hose must withstand.

The flex factor takes into consideration the magnitude of the flexing and its time cycle. A flexing that is rapid and continuous, even though of small magnitude, would be considered as severe as flexing that is large in magnitude but with an extremely long time cycle. The degree of flexing is an important factor in the ultimate life of the hose.

Refer to R.M.A. Technical Information Bulletin #1P-11-1.

Air Hose

Many fine types of air hose, equipped with tough, abrasion-resisting covers are offered tube stocks which will successfully resist oil mist, if present. Where tools are lubricated through hose, only the very best quality air hose with highest grade oil-resisting tube should be used. The recommended working pressure should be sufficient to withstand the maximum pressures encountered.

Water Hose

In the selection of the correct water hose for any service, the same principles apply as for air and steam hose.

Suction Hose

Most Continental ContiTech vacuum or suction hose are designed to withstand full vacuum. However, in some of the lighter styles, less than full vacuum is recommended.

Use the information in this catalog to help determine the best hose for your application. To assist your efforts to collect the data necessary to make a proper hose recommendation, use the form on the next page.

General Information

Industrial Hose Inquiry/Recommendation

Size
ID
OD
Hose Length (OAL or uncoupled length)
Tolerances
Temperature
Of Material Being Conveyed (High, Low, Ambient)
Of Outside Exposure (High, Low, Ambient)
Intermittent?
Constant?
Sub-zero Exposure?
Application(s)
Indoor and/or Outdoor Use
Intermittent or Continuous Use
Flexibility Required (Min. Bend Radius)
Movement (Static, Vibrations, Flexing)
External Conditions: Abrasion
Oil
Solvents
Acid
Ozone
Electrical/Static Conductive
Oil Resistance: Tube
Cover
Flame Resistance
Non-contaminating Materials Hose Currently in Use
Current Hose Service Life/Failure Description
Service Life Desired
Material(s) Being Conveyed
Solids (Size, Description)
Gaseous (Volatility, Inert)
Liquids (Flammability, Causticity, Acid/Alkaline, Solution/ Concentration)
Chemical Names (Generic)

Pressure(s)
Working Pressure (Including Surges)
Burst Pressure
Suction or Vacuum Requirements
Velocity
Impulse
Ends & Fittings
Factory Applied Fittings: Type of threads
Male/Female
Reusable/Nonreusable
Material for Fittings
Built-in Fittings / Ends: Beaded
Flanged
Rubber-Lined
Other
Cut to Length
Crimp Specs/Crimper (Hydraulics)
Delivery
Leadtime
Quantity
Stock/Nonstock
Special Print
Special Packaging
Other Information
Customer: _____ Date: _____
Customer #: _____
Ship To: _____
Bill To: _____
Telephone #: _____ Fax#: _____

- Air & Multipurpose**
 - General Purpose
 - Heavy Duty
 - Push-on
- Chemical Transfer**
- Cleaning Equipment**
- Food**
 - Transfer
 - Washdown
- Marine**
- Material Handling**
 - Abrasives
 - Bulk Transfer
 - Cement & Concrete
- Mining**
- Petroleum**
 - Aircraft Fueling
 - Dispensing
 - Dock
 - Transfer
- Spray**
- Steam**
- Vacuum**
- LPG Delivery**
- Water**
 - Discharge
 - Suction & Discharge
 - Washdown
- Welding**
- Coupling Systems**
- Equipment**

General Information

Temperature Conversion

Locate temperature in middle column. If in °C, read °F equivalent in right-hand column; if in °F, read °C in left-hand column.

	-459° to 0°			1° to 60°			61° to 290°			300° to 890°			900° to 3000°		
	C	CF	F	C	CF	F	C	CF	F	C	CF	F	C	CF	F
Air & Multipurpose															
General Purpose															
Heavy Duty															
Push-on															
Chemical Transfer															
Cleaning Equipment															
273	-459.4		-172	1	33.8	16.1	61	141.8	149	300	572	482	900	1652	
268	-450		-16.7	2	35.6	16.7	62	143.6	154	310	590	488	910	1670	
262	-440		-16.1	3	37.4	17.2	63	145.4	160	320	608	493	920	1688	
257	-430		-15.6	4	39.2	17.8	64	147.2	166	330	626	499	930	1706	
Food Transfer															
Washdown															
251	-420		-15.0	5	41.0	18.3	65	149.0	171	340	644	504	940	1724	
246	-410		-14.4	6	42.8	18.9	66	150.8	177	350	662	510	950	1742	
240	-400		-13.9	7	44.6	19.4	67	152.6	182	360	680	516	960	1760	
Marine															
234	-390		-13.3	8	46.4	20.0	68	154.4	188	370	698	521	970	1778	
Material Handling															
229	-380		-12.8	9	48.2	20.6	69	156.2	193	380	716	527	980	1796	
223	-370		-12.2	10	50.0	21.1	70	158.0	199	390	734	532	990	1814	
218	-360		-11.7	11	51.8	21.7	71	159.8	204	400	752	538	1000	1832	
212	-350		-11.1	12	53.6	22.2	72	161.6	210	410	770	549	1020	1868	
Abrasives															
Bulk Transfer															
Cement & Concrete															
207	-340		-10.6	13	55.4	22.8	73	163.4	216	420	788	560	1040	1904	
201	-330		-10.0	14	57.2	23.3	74	165.2	221	430	806	571	1060	1940	
196	-320		-9.4	15	59.0	23.9	75	167.0	227	440	824	582	1080	1976	
190	-310		-8.9	16	60.8	24.4	76	168.8	232	450	842	593	1100	2012	
Mining															
184	-300		-8.3	17	62.6	25.0	77	170.6	238	460	860	604	1120	2048	
179	-290		-7.8	18	64.4	25.6	78	172.4	243	470	878	616	1140	2084	
173	-280		-7.2	19	66.2	26.1	79	174.2	249	480	896	627	1160	2120	
169	-273	-459.4	-6.7	20	68.0	26.7	80	176.0	254	490	914	638	1180	2156	
Petroleum															
Aircraft Fueling															
168	-270	-454	-6.1	21	69.8	27.2	81	177.8	260	500	932	649	1200	2192	
162	-260	-436	-5.6	22	71.6	27.8	82	179.6	266	510	950	660	1220	2228	
157	-250	-418	-5.0	23	73.4	28.3	83	181.4	271	520	968	671	1240	2264	
151	-240	-400	-4.4	24	75.2	28.9	84	183.2	277	530	986	682	1260	2300	
Docking															
146	-230	-382	-3.9	25	77.0	29.4	85	185.0	282	540	1004	693	1280	2336	
140	-220	-364	-3.3	26	78.8	30.0	86	186.8	288	550	1022	704	1300	2372	
134	-210	-346	-2.8	27	80.6	30.6	87	188.6	293	560	1040	715	1320	2408	
129	-200	-328	-2.2	28	82.4	31.1	88	190.4	299	570	1058	726	1340	2444	
Spray															
123	-190	-310	-1.7	29	84.2	31.7	89	192.2	304	580	1076	737	1360	2480	
118	-180	-292	-1.1	30	86.0	32.2	90	194.0	310	590	1094	748	1380	2516	
112	-170	-274	-0.6	31	87.8	32.8	91	195.8	316	600	1112	759	1400	2552	
107	-160	-256	0.0	32	89.6	33.3	92	197.6	321	610	1130	770	1420	2588	
Steam															
101	-150	-238	0.6	33	91.4	33.9	93	199.4	327	620	1148	781	1440	2624	
96	-140	-220	1.1	34	93.2	34.4	94	201.2	332	630	1166	792	1460	2660	
90	-130	-202	1.7	35	95.0	35.0	95	203.0	338	640	1184	803	1480	2696	
84	-120	-184	2.2	36	96.8	35.6	96	204.8	343	650	1202	814	1500	2732	
Vacuum															
79	-110	-166	2.8	37	98.6	36.1	97	206.6	349	660	1220	825	1520	2768	
73	-100	-148	3.3	38	100.4	36.7	98	208.4	354	670	1238	836	1540	2804	
68	-90	-130	3.9	39	102.2	37.2	99	210.2	360	680	1256	847	1560	2840	
62	-80	-112	4.4	40	104.0	37.8	100	212.0	366	690	1274	858	1580	2876	
Water															
57	-70	-94	5.0	41	105.8	38.3	101	213.8	371	700	1292	869	1600	2912	
51	-60	-76	5.6	42	107.6	38.9	102	215.6	377	710	1310	880	1620	2948	
46	-50	-58	6.1	43	109.4	39.4	103	217.4	382	720	1328	891	1640	2984	
40	-40	-40	6.7	44	111.2	40.0	104	219.2	388	730	1346	902	1660	3020	
Suction & Discharge															
34	-30	-22	7.2	45	113.0	40.6	105	221.0	393	740	1364	913	1680	3056	
29	-20	-4	7.8	46	114.8	41.1	106	222.8	399	750	1382	924	1700	3092	
23	-10	14	8.3	47	116.6	41.7	107	224.6	404	760	1400	935	1720	3128	
178	0	32	8.9	48	118.4	42.2	108	226.4	410	770	1418	946	1740	3164	
			9.4	49	120.2	42.8	109	228.2	416	780	1436	957	1760	3200	
			10.0	50	122.0	43.3	110	230.0	421	790	1454	968	1780	3236	
			10.6	51	123.8	43.9	111	231.8	427	800	1472	979	1800	3272	
			11.1	52	125.6	44.4	112	233.6	432	810	1490	990	1820	3308	
			11.7	53	127.4	45.0	113	235.4	438	820	1508	1001	1840	3344	
			12.2	54	129.2	45.5	114	237.2	443	830	1526	1012	1860	3380	
			12.8	55	131.0	46.1	115	239.0	449	840	1544	1023	1880	3416	
			13.3	56	132.8	46.6	116	240.8	454	850	1562	1034	1900	3452	
			13.9	57	134.6	47.1	117	242.6	460	860	1580	1045	1920	3488	
			14.4	58	136.4	47.7	118	244.4	466	870	1598	1056	1940	3524	
			15.0	59	138.2	48.2	119	246.2	471	880	1616	1067	1960	3560	
			15.6	60	140.0	48.8	120	248.0	477	890	1634	1078	1980	3596	

General Information

Useful Conversion Charts

Decimal and Millimeter Equivalents of Fractions (Inches)

Fractions	Decimals	Millimeters	Fractions	Decimals	Millimeters
1/64	.015625	.397	33/64	.515625	13.097
1/32	.03125	.794	17/32	.53125	13.494
3/64	.046875	1.191	35/64	.546875	13.891
1/16	.0625	1.588	9/16	.5625	14.288
5/64	.078125	1.984	37/64	.578125	14.684
3/32	.09375	2.381	19/32	.59375	15.081
7/64	.109375	2.778	39/64	.609375	15.478
1/8	.125	3.175	5/8	.625	15.875
9/64	.140625	3.572	41/64	.640625	16.272
5/32	.15625	3.969	21/32	.65625	16.669
11/64	.171875	4.366	43/64	.671875	17.066
3/16	.1875	4.763	11/16	.6875	17.463
13/64	.203125	5.159	45/64	.703125	17.859
7/32	.21875	5.556	23/32	.71875	18.256
15/64	.234375	5.953	47/64	.734375	18.653
1/4	.250	6.350	3/4	.750	19.050
17/64	.265625	6.747	49/64	.765625	19.447
9/32	.28125	7.144	25/32	.78125	19.844
19/64	.296875	7.541	51/64	.796875	20.241
5/16	.3125	7.938	13/16	.8125	20.638
21/64	.328125	8.334	53/64	.828125	21.034
11/32	.34375	8.731	27/32	.84375	21.431
23/64	.359375	9.128	55/64	.859375	21.828
3/8	.375	9.525	7/8	.875	22.225
25/64	.390625	9.922	57/64	.890625	22.622
13/32	.40625	10.319	29/32	.90625	23.019
27/64	.421875	10.716	59/64	.921875	23.416
7/16	.4375	11.113	15/16	.9375	23.813
29/64	.453125	11.509	61/64	.953125	24.209
15/32	.46875	11.906	31/32	.96875	24.606
31/64	.484375	12.303	63/64	.984375	25.003
1/2	.500	12.700	1	1.000	25.400

Pressure Conversion (feet of water to pounds per square inch)

Based on formula (psi) = Pressure Head [ft. of water] x 0.433

Pressure Head (Ft. of Water)	Pressure (psi)	Pressure Head (Ft. of Water)	Pressure (psi)	Pressure Head (Ft. of Water)	Pressure (psi)
0	0	200	87	410	177
5	2.2	210	91	420	182
10	4.3	220	95	430	186
20	8.7	230	100	440	190
30	13	240	104	450	195
40	17	250	108	460	199
50	22	260	113	470	203
60	26	270	117	480	208
70	30	280	121	490	212
80	35	290	126	500	216
90	39	300	130	550	238
100	43	310	134	600	260
110	48	320	139	650	281
120	52	330	143	700	303
130	56	340	147	750	325
140	61	350	151	800	346
150	65	360	156	850	368
160	69	370	160	900	390
170	74	380	164	950	411
180	78	390	169	1000	433
190	82	400	173		

Pressure Conversions

(feet of water to inches of mercury)

Feet of Water	Inches of Mercury
1	0.9
2	1.8
4	3.5
6	5.3
8	7.1
10	8.8
12	10.6
14	12.4
16	14.1
18	15.9
20	17.7
22	19.4
24	21.2
26	23.0
28	24.8
30	26.5
32	28.3
34	30.0

Measures of Pressures

1 lb. per square inch = 144 lb. per square foot = 0.068 atmosphere = 2.042 inches of mercury @ 62°F (17°C) = 2.31 feet of water at 62°F (17°C).

1 atmosphere = 30 inches of mercury at 62°F (17°C) = 14.7 lbs. per square inch = 2116.3 lb. per square foot = 33.95 feet of water at 62°F (17°C).

1 foot of water at 62°F (17°C) = 62.355 lbs. per square foot = 0.433 lb. per square inch.

1 inch of mercury at 62°F (17°C) = 1.132 feet of water = 13.58 inches of water = 0.491 lb. per square inch.

Column of water 12 inches high, 1 inch diameter = .341 lb.

Air & Multipurpose
General Purpose
Heavy Duty
Push-on

Chemical Transfer

Cleaning Equipment

Food
Transfer
Washdown

Marine

Material Handling
Abrasives
Bulk Transfer
Cement & Concrete

Mining

Petroleum
Aircraft Fueling
Dispensing
Dock
Transfer

Spray

Steam

Vacuum

LPG Delivery

Water
Discharge
Suction & Discharge
Washdown

Welding

Coupling Systems

Equipment

Appendix

General Information

Air & Multipurpose

General Purpose
Heavy Duty
Push-on

Chemical Transfer

Cleaning Equipment

Food
Transfer
Washdown

Marine

Material Handling

Abrasives
Bulk Transfer
Cement & Concrete

Mining

Petroleum
Aircraft Fueling

Dispensing
Dock
Transfer

Spray

Steam

Vacuum

LPG Delivery

Water
Discharge
Suction & Discharge
Washdown

Welding

Coupling Systems

Equipment

Length Conversion Constants

Metric to U.S.	U.S. to Metric
Millimeters x .039370 = inches	Inches x 25.4001 = millimeters
Meters x 39.370 = inches	Inches x .0254 = meters
Meters x 3.2808 = feet	Feet x .30480 = meters
Meters x 1.09361 = yards	Yards x .91440 = meters
Kilometers x 3,280.8 = feet	Feet x .0003048 = kilometers
Kilometers x .62137 = statute miles	Statute Miles x 1.60935 = kilometers
Kilometers x .53959 = nautical miles	Nautical Miles x 1.85325 = kilometers

Weight Conversion Constants

Metric to U.S.	U.S. to Metric
Grams x 981 = dynes	Dynes x .0010193 = grams
Grams x 15.432 = grains	Grains x .0648 = grams
Grams x .03527 = ounces (Avd.)	Ounces (Avd.) x 28.35 = grams
Grams x .033818 = fluid ounces (water)	Fluid Ounces (Water) x 29.57 = grams
Kilograms x 35.27 = ounces (Avd.)	Ounces (Avd.) x .02835 = kilograms
Kilograms x 2.20462 = pounds (Avd.)	Pounds (Avd.) x .45359 = kilograms
Metric tons (1000Kg) x 1.10231 = net ton (2000 lbs.)	Net ton (2000 lbs.) x .90719 = metric tons (1000Kg)
Metric tons (1000Kg) x .98421 = gross ton (2240 lbs.)	Gross ton (2240 lbs.) x 1.101605 = metric tons (1000Kg)

Area Conversion Constants

Metric to U.S.	U.S. to Metric
Square millimeters x .00155 = square inches	Square inches x 645.163 = square millimeters
Square centimeters x .155 = square inches	Square inches x 6.45163 = square centimeters
Square meters x 10.76387 = square feet	Square feet x .0929 = square meters
Square meters x 1.19599 = square yards	Square yards x .83613 = square meters
Hectares x 2.47104 = acres	Acres x .40469 = hectares
Square kilometers x 247.104 = acres	Acres x .0040469 = square kilometers
Square kilometers x .3861 = square miles	Square miles x 2.5899 = square kilometers

General Information

Properties of Saturated Steam

The steam pressure is important because it determines the minimum temperature condition under which the hose will be used. The operating temperature is a very important factor in selecting a steam hose as a relatively small increase in temperature can greatly reduce the hose life.

Pressure-Temperature Equivalents of Saturated Steam

Lbs. per sq. in. Pressure	Temperature		Lbs. per sq. in. Pressure	Temperature	
	°F	°C		°F	°C
0	212.0	100.0	110	344.1	173.4
5	227.1	108.4	115	347.2	175.1
10	239.4	115.2	120	350.1	175.7
15	249.8	121.0	125	352.9	178.3
20	258.8	126.0	130	355.6	179.8
22	261.2	127.8	135	358.3	181.3
24	265.3	129.6	140	360.9	182.7
26	268.3	131.3	145	363.4	184.1
28	271.2	132.9	150	365.9	185.5
30	274.1	134.5	155	368.2	186.8
32	276.8	136.0	160	370.6	188.1
34	279.3	137.4	165	373.9	189.4
36	281.8	138.8	170	375.3	190.7
38	284.4	140.2	175	377.4	191.9
40	286.7	141.5	180	379.6	193.1
42	289.0	142.8	185	381.7	194.3
44	291.2	144.0	190	383.7	195.4
46	293.5	145.3	195	385.9	196.6
48	295.5	146.4	200	387.9	197.7
50	294.7	147.6	205	398.8	198.8
52	299.9	148.7	210	391.6	199.8
54	301.6	149.8	215	392.9	200.5
56	303.6	150.9	220	395.4	201.7
58	308.4	151.9	225	397.2	202.9
60	307.4	153.0	230	399.0	203.9
62	309.2	154.0	235	400.7	204.8
64	310.8	154.9	240	402.5	205.8
66	312.6	155.9	245	404.2	206.8
68	314.2	156.8	250	406.1	207.8
70	316.0	157.0	255	407.7	208.7
72	317.7	158.7	260	409.4	209.7
74	319.3	159.6	265	411.0	210.6
76	320.9	160.5	270	412.6	211.4
78	322.3	161.3	275	414.2	202.3
80	323.8	162.1	280	415.7	213.2
85	327.6	164.2	300	421.0	216.1
90	331.2	166.2	350	436.5	224.7
95	334.6	168.1			
100	337.8	169.9			
105	341.1	171.7			

Air & Multipurpose
General Purpose
Heavy Duty
Push-on

Chemical Transfer

Cleaning Equipment

Food
Transfer
Washdown

Marine

Material Handling
Abrasives
Bulk Transfer
Cement & Concrete

Mining

Petroleum
Aircraft Fueling
Dispensing
Dock
Transfer

Spray

Steam

Vacuum

LPG Delivery

Water
Discharge
Suction & Discharge
Washdown

Welding

Coupling Systems

Equipment

Appendix

General Information

Flow Data

This table may be used to determine the pressure loss in hose connected to rock drills and pneumatic tools. It is correct for hose with smooth inside lining. Hose with rough inside lining may have a friction loss of as much as 50% greater than the figures given in the table.

Air Flow Pressure Loss - Pulsating flow

Size Of Hose	Gauge Pressure at Line	Cubic feet free air per minute passing through 50 foot lengths of hose Loss of pressure in pounds per square inch - 50 foot hose length																
		20	30	40	50	60	70	80	90	100	110	120	130	140	150			
		½ In. With Couplings At Each End																
Material Handling Abrasives Bulk Transfer Cement & Concrete	50	1.8	5.0	10.1	18.1													
	60	1.3	4.0	8.4	14.8	23.4												
	70	1.0	3.4	7.0	12.4	20.0	28.4											
	80	.9	2.8	6.0	10.8	17.4	25.2	34.6										
	90	.8	2.4	5.4	9.5	14.8	22.0	30.5	41.0									
	100	.7	2.3	4.8	8.4	13.3	19.3	27.2	36.6									
Mining	110	.6	2.0	4.3	7.6	12.0	17.6	24.6	33.3	44.5								
	50	.4	.8	1.5	2.4	3.5	4.4	6.5	8.5	11.4	14.2							
	60	.3	.6	1.2	1.9	2.8	3.8	5.2	6.8	8.6	11.2							
	70	.2	.5	.9	1.5	2.3	3.2	4.2	5.5	7.0	8.8	11.0						
	80	.2	.5	.8	1.3	1.9	2.8	3.6	4.7	5.8	7.2	8.8	10.6					
	90	.2	.4	.7	1.1	1.6	2.3	3.1	4.0	5.0	6.2	7.5	9.0					
Petroleum Aircraft Fueling Dispensing Dock Transfer	100	.2	.4	.6	1.0	1.4	2.0	2.7	3.5	4.4	5.4	6.6	7.9	9.4	11.1			
	110	.1	.3	.5	.9	1.3	1.8	2.4	3.1	3.9	4.9	5.9	7.1	8.4	9.9			
	50	.1	.2	.3	.5	.8	1.1	1.5	2.0	2.6	3.5	4.8	7.0					
	60	.1	.2	.3	.4	.6	.8	1.2	1.5	2.0	2.6	3.3	4.2	5.5	7.2			
	70		.1	.2	.4	.5	.7	1.0	1.3	1.6	2.0	2.5	3.1	3.8	4.7			
	80		.1	.2	.3	.5	.7	.8	1.1	1.4	1.7	2.0	2.4	2.7	3.5			
Steam	90		.1	.2	.3	.4	.6	.7	.9	1.2	1.4	1.7	2.0	2.4	2.8			
	100		.1	.2	.2	.4	.5	.6	.8	1.0	1.2	1.5	1.8	2.1	2.4			
	110		.1	.2	.2	.3	.4	.6	.7	.9	1.1	1.3	1.5	1.8	2.1			
	50				.1	.2	.2	.3	.4	.5	.7	1.1						
	60					.1	.2	.3	.3	.5	.6	.8	1.0	1.2	1.5			
	70					.1	.2	.2	.3	.4	.4	.5	.7	.8	1.0	1.3		
Water Discharge Suction & Discharge Washdown	80					.1	.2	.2	.3	.4	.5	.6	.7	.8	1.0			
	90						.1	.2	.2	.3	.3	.4	.5	.6	.7	.8		
	100							.1	.2	.2	.3	.4	.4	.5	.6	.7		
	110								.1	.2	.2	.3	.3	.4	.5	.6		
	50									.1	.2	.2	.3	.3	.4	.5	.6	
	60										.1	.2	.2	.2	.3	.3	.4	.5
Coupling Systems	70										.1	.2	.2	.2	.3	.3	.4	
	80											.1	.2	.2	.2	.3	.4	
	90												.1	.2	.2	.2	.3	
	100													.1	.2	.2	.2	
	110														.1	.2	.2	.2

For longer or shorter lengths of hose, the friction loss is proportional to the length, e.g., for 25 feet, half of the above; for 150 feet, three times the above, etc.

General Information

Flow Data (continued)

Water Flow Pressure Loss (psi per 100 feet of hose)

Flow of water in U.S. gal. per min.	Flow of water in cu. feet per sec.	Actual Internal Diameter (in.)									
		1/2	5/8	3/4	1	1 1/4	1 1/2	2	2 1/2	3	
0.5	.001	0.4									
1.5	.003	3.02	1.01	0.42							
2.5	.005	7.75	2.58	1.08							
5	.011	27.8	9.27	3.86	0.95	0.32	0.13				
10	.022	99.5	33.2	13.8	3.38	1.14	0.47	0.12			
15	.033		71.0	29.6	7.25	2.45	1.01	0.25	0.08		
20	.044		121.0	50.3	12.4	4.15	1.71	0.42	0.14		
25	.055			76.5	18.7	6.34	2.60	0.64	0.22		
30	.066			108.0	26.5	8.96	3.68	0.90	0.30	0.13	
35	.077			142.0	34.8	11.8	4.83	1.18	0.40	0.17	
40	.088				44.7	15.1	6.20	1.52	0.51	0.21	
45	.099				55.0	18.6	7.65	1.87	0.63	0.26	
50	.110				67.5	22.8	9.35	2.28	0.78	0.32	
60	.132				94.3	31.8	13.1	3.19	1.08	0.45	
70	.154				126.0	42.5	17.5	4.25	1.44	0.60	
80	.176					54.6	22.5	5.48	1.86	0.77	
90	.198					67.5	27.8	6.80	2.30	0.95	
100	.223					81.5	33.5	8.19	2.78	1.15	
125	.278					124.0	50.6	12.4	4.20	1.73	
150	.334						72.1	17.6	6.97	2.46	
175	.390						94.5	23.1	7.83	3.23	
200	.446						122.0	29.6	10.1	4.15	
225	.501							36.8	12.5	5.15	
250	.557							44.6	15.2	6.28	
275	.613							53.3	18.1	7.45	
300	.688							62.5	21.2	8.75	
325	.724							72.5	24.6	10.2	
350	.780							83.2	28.2	11.7	
375	.836							94.5	32.1	13.3	
400	.891							107.0	36.2	14.9	
450	1.00								44.9	18.6	
500	1.11								54.5	22.5	
600	1.34								76.5	31.6	
700	1.56								102.0	42.1	
800	1.78								131.0	53.9	
900	2.00									66.8	
1000	2.23									81.4	
1100	2.45									97.0	
1200	2.67									114.0	
1300	2.90									132.0	
1400	3.12										
1500	3.34										
1600	3.56										
1800	4.01										
2000	4.45										

Note: The pressure loss experienced by a liquid flowing through a hose depends on the rate of flow, the viscosity of the liquid, the hose ID, the smoothness of the tube and the hose length. This chart shows the relationship between rate of flow, ID, and pressure loss for water at 68°F (20°C) with a viscosity of one centipoise. The pressure is directly proportional to the length of the hose, therefore, the data shown can be easily extended by use of proportions, e.g., the pressure drop for 50 feet of hose length is half that for 100 feet.

Air & Multipurpose
General Purpose
Heavy Duty
Push-on

Chemical Transfer

Cleaning Equipment

Food
Transfer
Washdown

Marine

Material Handling
Abrasives
Bulk Transfer
Cement & Concrete

Mining

Petroleum
Aircraft Fueling
Dispensing
Dock
Transfer

Spray

Steam

Vacuum

LPG Delivery

Water
Discharge
Suction & Discharge
Washdown

Welding

Coupling Systems

Equipment

Appendix

General Information

Flow Data (continued)

Water Flow Pressure Loss (PSI per 100 feet of hose)

	Flow of water in U.S. gal. per min.	Flow of water in cu. feet per sec.	Actual Internal Diameter (in.)							
			4	6	8	10	12	14	16	
Air & Multipurpose										
General Purpose										
Heavy Duty										
Push-on										
Chemical Transfer										
Cleaning Equipment	100	.223	.26							
	125	.278	.40							
Food	150	.334	.54							
Transfer	175	.390	.70	.10						
Washdown	200	.446	.90	.13						
	225	.501	1.08	.16						
Marine	250	.557	1.34	.19						
	275	.613	1.60	.24						
	300	.668	1.84	.28						
Material Handling	325	.724	2.04	.33						
Abrasives	350	.780	2.30	.37						
Bulk Transfer	375	.836	2.80	.44						
Cement & Concrete	400	.891	3.10	.49						
	425	.947	3.40	.54						
Mining	450	1.00	3.80	.60						
	475	1.06	4.25	.70						
	500	1.11	4.60	.78	.16					
Petroleum	550	1.22	5.60	.93	.18					
Aircraft Fueling	600	1.34	6.60	1.10	.23					
Dispensing	650	1.45	7.60	1.30	.27					
Dock	700	1.56	8.60	1.50	.30					
Transfer	750	1.67	9.60	1.70	.34					
	800	1.78	10.80	1.90	.39					
Spray	850	1.89	12.00	2.20	.44					
	900	2.00		2.40	.49					
	950	2.12		2.60	.54					
Steam	1000	2.23		2.80	.59	.19				
	1100	2.45		3.20	.66	.23				
Vacuum	1200	2.67		3.70	.74	.27				
	1300	2.90		4.50	.88	.31				
LPG Delivery	1400	3.12		5.30	1.10	.35	.15			
	1500	3.34		6.20	1.25	.40	.17			
	1600	3.56		7.00	1.40	.45	.19			
Water	1800	4.01		8.80	1.80	.54	.24			
Discharge	2000	4.45		16.50	2.20	.64	.29	.14		
Suction & Discharge	2500	5.57			3.40	.98	.42	.21		
Washdown	3000	6.68			4.50	1.40	.58	.29	.14	
	3500	7.80			6.20	1.90	.79	.39	.18	
	4000	8.91			8.20	2.40	1.00	.50	.23	
Welding	4500	10.03			10.20	3.00	1.25	.62	.28	
	5000	11.14				3.80	1.50	.74	.34	
Coupling Systems	6000	13.37				5.20	2.10	1.10	.46	
	7000	15.60				7.00	2.80	1.40	.62	
	8000	17.82				9.20	3.70	1.80	.80	
Equipment	9000	20.05				11.50	4.60	2.30	1.00	
	10000	22.28					5.70	2.80	1.25	
	12000	26.74					6.70	3.70	1.70	
	14000	31.19					10.00	5.00	2.40	
	16000	35.65					13.50	6.80	3.30	
	18000	40.10						8.80	4.40	
	20000	44.56						11.00	5.50	

General Information

Open-end Discharge

The term "open-end discharge" refers to a hose which empties a fluid into the atmosphere. Even though one end is open, the pressure is not low throughout the hose.

The inlet end pressure is equal to that in the line to which the hose is connected unless the flow rate is so low that the hose is not completely filled. The pressure along the hose length drops from a maximum at the inlet to zero at the outlet and the pressure at any given point along the length is nearly proportional to the distance from the hose inlet.

The following table shows the flow in gallons per minute for various sizes of hoses in open-end discharge service.

Open-End Flow (GPM)

	Pressure at Inlet, psi	Hose Length (ft.)							
		25	50	75	100	125	150	200	300
1/2" Hose	30	10.4	6.2	5.6	4.8	4.3	3.8	3.3	2.6
	40	12.1	8.5	6.2	5.6	5.0	4.5	3.8	3.2
	50	13.8	9.4	7.5	6.4	5.6	5.1	4.0	3.5
	60	15.2	10.4	8.5	7.1	6.2	5.6	4.9	3.8
	70	16.6	11.2	9.0	7.8	6.8	6.2	5.3	4.2
	80	18.0	12.1	9.8	8.5	7.3	6.6	5.6	4.5
	90	19.0	13.0	10.4	8.8	7.7	7.1	6.0	4.8
	100	20.1	13.8	11.0	9.4	8.5	7.5	6.4	4.9
	125	22.8	15.5	12.5	10.5	9.4	8.5	7.2	5.8
	5/8" Hose	30	18.1	12.5	10.3	8.7	7.7	7.0	6.0
40		21.4	14.8	12.5	10.3	9.0	8.3	7.0	5.7
50		23.9	16.5	13.2	11.4	10.3	9.2	7.9	6.3
60		26.5	18.1	14.8	12.5	11.2	10.3	8.7	7.0
70		27.5	20.0	16.0	13.7	12.0	11.0	10.0	7.6
80		30.6	21.4	16.8	14.8	13.0	11.8	10.3	8.3
90		32.5	22.5	18.1	15.5	14.0	12.5	10.5	8.7
100		34.5	23.9	19.0	16.6	14.8	13.2	11.4	9.2
125		39.0	27.0	21.5	18.5	16.6	15.0	12.9	10.5
3/4" Hose		30	31.0	21.3	17.2	14.8	13.0	11.8	10.2
	40	36.0	25.0	20.0	17.2	15.2	13.8	11.8	9.4
	50	41.0	28.0	22.5	19.2	17.2	15.5	13.2	10.7
	60	45.5	31.0	25.0	21.3	19.0	17.2	14.8	11.8
	70	49.5	34.0	27.2	23.5	21.0	18.8	17.1	12.8
	80	53.0	36.0	29.1	25.0	22.0	20.0	17.2	13.8
	90	56.2	39.0	31.0	27.0	23.8	21.3	18.2	14.8
	100	60.0	41.0	33.0	28.0	25.0	22.6	19.2	15.5
	125	68.0	46.0	37.5	32.0	23.0	25.8	21.8	17.5

	Pressure at Inlet, psi	Hose Length (ft.)							
		25	50	75	100	125	150	200	300
1" Hose	30	68.0	46.2	37.5	32.0	28.5	25.8	22.0	17.8
	40	79.0	54.4	44.0	37.5	33.0	30.0	25.8	20.8
	50	89.0	62.0	49.0	42.0	37.5	34.0	29.0	23.3
	60	100.0	68.0	54.4	46.2	41.8	37.5	32.0	25.8
	70	—	74.0	59.0	51.0	45.0	40.8	37.3	28.0
	80	—	79.0	63.0	54.4	48.0	43.0	37.5	30.0
	90	—	84.0	68.0	58.0	51.8	46.2	40.0	32.0
	100	—	89.0	71.0	62.0	54.4	49.0	42.0	34.0
	125	—	101.0	80.0	68.0	62.0	55.8	47.8	38.0
	1 1/4" Hose	50	—	110.0	85.0	72.0	56.0	58.0	50.0
75		—	130.0	110.0	90.0	80.0	73.0	64.0	52.0
100		—	150.0	125.0	110.0	92.0	85.0	73.0	58.0
150		—	—	150.0	130.0	120.0	110.0	90.0	67.0
1 3/8" Hose	50	—	140.0	115.0	96.0	85.0	75.0	65.0	54.0
	75	—	170.0	140.0	125.0	110.0	96.0	84.0	67.0
	100	—	205.0	160.0	140.0	125.0	110.0	96.0	75.0
	150	—	—	205.0	170.0	155.0	140.0	125.0	97.0
1 1/2" Hose	50	—	180.0	150.0	130.0	120.0	105.0	90.0	74.0
	75	—	230.0	180.0	160.0	145.0	130.0	120.0	90.0
	100	—	260.0	220.0	180.0	170.0	150.0	130.0	105.0
	150	—	—	260.0	230.0	205.0	180.0	160.0	130.0
2" Hose	50	—	380.0	310.0	270.0	240.0	210.0	180.0	150.0
	75	—	480.0	380.0	330.0	290.0	270.0	230.0	180.0
	100	—	550.0	450.0	380.0	350.0	310.0	260.0	215.0
	125	—	—	550.0	480.0	425.0	380.0	330.0	265.0

Air & Multipurpose
General Purpose
Heavy Duty
Push-on

Chemical Transfer

Cleaning Equipment

Food
Transfer
Washdown

Marine

Material Handling
Abrasives
Bulk Transfer
Cement & Concrete

Mining

Petroleum
Aircraft Fueling
Dispensing
Dock
Transfer

Spray

Steam

Vacuum

LPG Delivery

Water
Discharge
Suction & Discharge
Washdown

Welding

Coupling Systems

Equipment

Appendix

General Information

Air & Multipurpose
 General Purpose
 Heavy Duty
 Push-on

Chemical Transfer

Cleaning Equipment

Food
 Transfer
 Washdown

Marine

Material Handling
 Abrasives
 Bulk Transfer
 Cement & Concrete

Mining

Petroleum
 Aircraft Fueling
 Dispensing
 Dock
 Transfer

Spray

Steam

Vacuum

LPG Delivery

Water
 Discharge
 Suction & Discharge
 Washdown

Welding

Coupling Systems

Equipment

Appendix

Fluid Velocity vs. Flow Rate

The graph below illustrates the fluid velocity for flow rates up to 10,000 GPM for hose from 1" through 10" ID

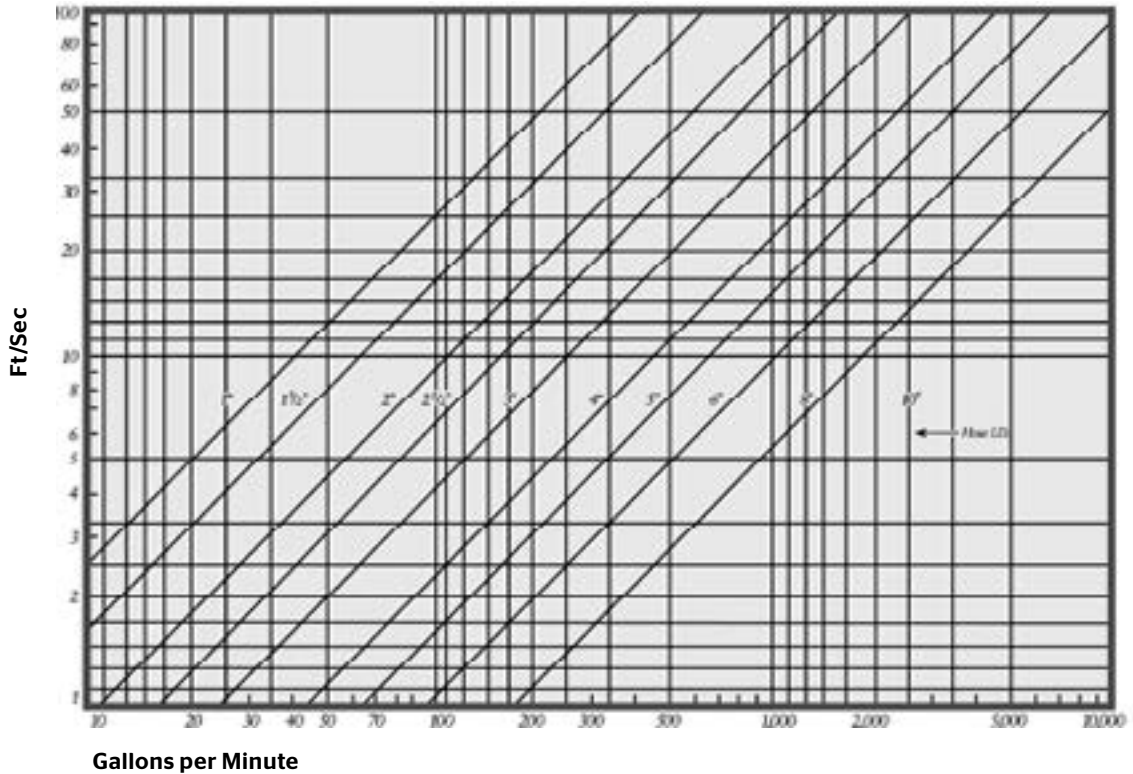

General Information

RMA Oil and Gasoline Resistance

Rubber hose is used to convey petroleum products both in the crude and refined stages. The aromatic content of refined gasoline is often adjusted to control the octane rating. The presence of aromatic hydrocarbons in this fuel generally has a greater effect on rubber components than do aliphatic hydrocarbons. Aromatic materials in contact with rubber tend to soften it and reduce its physical properties. For long-lasting service, the buyer of gasoline hose should inform the hose manufacturer of the aromatic content of the fuel to be handled so that the proper tube compound can be recommended for the specific application.

The effects of oil on rubber depend on a number of factors that include the type of rubber compound the composition of the oil, the temperature and time of exposure. Rubber compounds can be classified as to their degree of oil resistance based on their physical properties after exposure to a standard test fluid. In this RMA classification, the rubber samples are immersed in IRM 903 oil at 212°F (100°C) for 70 hours. (See ASTM Method D-471 for a detailed description of the oil and the testing procedure.) As a guide to the user of hose in contact with oil, the oil resistance classes and a corresponding description are listed.

(Reprinted From RMA Hose Handbook IP-2 2003 Edition)

Physical Properties After Exposure to Oil

	Volume Change Maximum	Tensile Strength Retained
Class A (High Oil Resistance)	+25%	80%
Class B (Medium Oil Resistance)	+65%	50%
Class C (Limited Oil Resistance)	+100%	40%

Air & Multipurpose

General Purpose
Heavy Duty
Push-on

Chemical Transfer

Cleaning Equipment

Food

Transfer
Washdown

Marine

Material Handling

Abrasives
Bulk Transfer
Cement & Concrete

Mining

Petroleum

Aircraft Fueling
Dispensing
Dock
Transfer

Spray

Steam

Vacuum

LPG Delivery

Water

Discharge
Suction & Discharge
Washdown

Welding

Coupling Systems

Equipment

Appendix

General Information

Air & Multipurpose

General Purpose
Heavy Duty
Push-on

Chemical Transfer

Cleaning Equipment

Food
Transfer
Washdown

Marine

Material Handling
Abrasives
Bulk Transfer
Cement & Concrete

Mining

Petroleum
Aircraft Fueling
Dispensing
Dock
Transfer

Spray

Steam

Vacuum

LPG Delivery

Water
Discharge
Suction & Discharge
Washdown

Welding

Coupling Systems

Equipment

Appendix

Food Hose Standards

FDA Compliant

All Continental ContiTech hoses having the "FDA" designation have tubes made with FDA/USDA compliant materials. The requirements for rubber tubes are described in the Code of Federal Regulations standard 21 CFR 177.2600 while plastic tubes are described in 21 CFR 175.300.

NSF 61

Clear Pliovic® tubes are certified as meeting the NSF 61 potable water standard.

3-A Sanitary

All Continental ContiTech rubber hoses having the "3-A" designation meet the requirements of the dairy industrial standard described in 3-A Sanitary Standard 18-03, Class III which determines rubber materials suitable for temperature of exposure to product up to 120°F (49°C) and temperature of exposure to chemical solutions used in cleaning and bacterial treatment up to 180°F (82°C).

All Continental ContiTech plastic hoses having the "3-A" designation meet the requirements of the dairy industrial standard described in 3-A Sanitary Standard 20-20 and are recommended for transmission of raw and pasteurized milk and other high water content dairy items.

In order to ensure compliance with the above standards, all Continental ContiTech hoses shall be thoroughly cleansed prior to their first use in accordance with good manufacturing and use practices.

General Information

Precautions for Welding Hose Use

Foreword

This bulletin is issued to alert dealers and users of welding hose that special hose may be necessary for use with certain fuel gases.

Scope

This bulletin relates to welding hose manufactured in conformance to RMA/CGA specification or to welding hose conforming to individual manufacturer or user specifications.

Caution

The fuel gases listed below are recorded to alert welding hose users to a potential hazard with these or similar gases. It should be noted that no condemnation of any of the gases listed is intended. The purpose is to advise against the use of hose that may not be designed for a particular gas or pressure. A user of any fuel gas is urged to relate the type of gas along with the expected working pressure (regulator setting) to the hose manufacturer for a specific hose recommendation.

Alert Listing

These and similar fuel gases may damage some grades or types of welding hose:

Apachi, Flamex, Mapp, Propane, Propylene

Use of the indicated or similar fuel gases at regulator settings above 40 psi may be particularly hazardous.

Users are also alerted against the use of acetylene at any pressure above 15 psi.

In-service Caution

The user is first cautioned to shut off the gas at the torch and then at the regulator or supply source when the torch will not be used for periods in excess of 30 minutes, in order to limit permeation of gas through the hose wall.

The user is further cautioned not to shut off the fuel gas at the regulator or supply source first as a flashback may result and thereby damage the hose.

Adequate ventilation must be provided in confined areas where fuel gas is being used to prevent the accumulation or concentration of gas that could be explosive or otherwise harmful to personnel.

Warning

The Use of Certain Fuel Gases May Damage Welding Hose and Lead to Fires and Explosions.

Air & Multipurpose

General Purpose
Heavy Duty
Push-on

Chemical Transfer

Cleaning Equipment

Food

Transfer
Washdown

Marine

Material Handling

Abrasives
Bulk Transfer
Cement & Concrete

Mining

Petroleum

Aircraft Fueling
Dispensing
Dock
Transfer

Spray

Steam

Vacuum

LPG Delivery

Water

Discharge
Suction & Discharge
Washdown

Welding

Coupling Systems

Equipment

Appendix

General Information

Production Run Minimum Requirements Key

	Order Code Prefix	Manufacturing Facility	Size (ID)	Construction	Minimum Production Run		
Air & Multipurpose General Purpose Heavy Duty Push-on	532	Norfolk	3/16"-2"	Textile Reinforcement	2,500 feet		
			3/16"-2"	Wire Reinforcement	2,500 feet		
	535	Norfolk	3/16"-1/2"	Textile Reinforcement	5,000 feet		
Chemical Transfer	536	Norfolk	5/8"-2"		2,500 feet		
			3/16"-1/2"	Textile Reinforcement	2,500 feet		
Cleaning Equipment	537	Cosmoflex	5/8"-2"		2,500 feet		
			11/4"-11/2"		4,500 feet		
Food Transfer Washdown	539	Norfolk	2"		4,500 feet		
			2 1/2"-3"		4,500 feet		
			4"		3,300 feet		
Marine	540	Cosmoflex	6"		1,800 feet		
			3/16"-1/2"	Wire Reinforcement	5,000 feet		
Material Handling Abrasives Bulk Transfer Cement & Concrete	541	Granford	5/8"-2"		2,500 feet		
			1/4"-3/8"		15,000 feet		
			1/2"-1"		5,000 feet		
Mining	542	Granford	1"-12"	Hand Built	Built to length, Max. 100'		
			12"-18"	Hand Built	Built to length, Max. 50'		
Petroleum Aircraft Fueling Dispensing Dock Transfer	543	Granford	1/2"-6 5/8"	Ply or Ply with Helic Wire	400 feet increments ¹		
			546	Granford	1/2"-6 5/8"	Ply or Ply with Helic Wire	400 feet increments ¹
			549	Granford	1/2"-6 5/8"	Ply or Ply with Helic Wire	400 feet increments ¹
Spray	569*	Mt. Pleasant	3/16"-1 1/2"		5,000 feet		
			586	Cosmoflex	3/4"-1"		3,000 feet
Steam	595*	Mt. Pleasant	1 1/4"-2"		2,000 feet		
			2 1/2"-3"		1,000 feet		
			4"		700 feet		
Vacuum	598*	Mt. Pleasant	5"		500 feet		
			6"		300 feet		
LPG Delivery	598*	Mt. Pleasant	7"		200 feet		
			8"-10"		200 feet		
			3/16"-1/2"		5,000 feet		
Water Discharge Suction & Discharge Washdown	598*	Mt. Pleasant	5/8"-1"		5,000 feet		
			1 1/4"-2"		5,000 feet		
Welding	598*	Mt. Pleasant	3/16"-1/2"		5,000 feet		
			5/8"-1"		5,000 feet		
Coupling Systems	598*	Mt. Pleasant	1 1/4"-2"		5,000 feet		
			3/16"-1/2"		5,000 feet		
Equipment	598*	Mt. Pleasant	5/8"-1"		5,000 feet		
			1 1/4"-2"		5,000 feet		

Note: Certain special manufacturing items may require longer minimum runs.

Samples: Contact Customer Service for sample availability.

*Minimum production runs are a guide only, they are subject to change without notification.

¹Granford hoses with ply/helic wire construction in 6" ID and above require a 200' increment production run.

General Information

Care, Maintenance and Storage

Reprinted from RMA Hose Handbook IP-2 Seventh Edition 2003

Hose has a limited life and the user must be alert to signs of impending failure, particularly when the conditions of service include high working pressures and/or the conveyance or containment of hazardous materials. The periodic inspection and testing procedures described here provide a schedule of specific measures which constitute a minimum level of user action to detect signs indicating hose deterioration or loss of performance before conditions leading to malfunction or failure are reached.

Safety Warning:

Failure to properly follow the manufacturer's recommended procedures for the care, maintenance and storage of a particular hose might result in its failure to perform in the manner intended and might result in possible damage to property and serious bodily injury.

General instructions are also described for the proper storage of hose to minimize deterioration from exposure to elements or environments which are known to be deleterious to rubber products. Proper storage conditions can enhance and extend substantially the ultimate life of hose products.

General Care and Maintenance

Hose should not be subjected to any form of abuse in service. It should be handled with reasonable care. Hose should not be dragged over sharp or abrasive surfaces unless specifically designed for such service. Care should be taken to protect hose from severe end loads for which the hose or hose assembly were not designed. Hose should be used at or below its rated working pressure; any changes in pressure should be made gradually so as not to subject the hose to excessive surge pressures. Hose should not be kinked or run over by equipment. In handling large size hose, dollies should be used whenever possible; slings or handling rigs, properly placed, should be used to support heavy hose used in oil suction and discharge service.

General Test & Inspection Procedures

An inspection and hydrostatic test should be made at periodic intervals to determine if a hose is suitable for continued service. A visual inspection of the hose should be made for loose covers, kinks, bulges or soft spots which might indicate broken or displaced reinforcement. The couplings or fittings should be closely examined and, if there is any sign of movement of the hose from the couplings, the hose should be removed from service.

The periodic inspection should include a hydrostatic test for one minute at 150% of the recommended working pressure of the hose. An exception to this would be the woven jacketed fire

hose.* During the hydrostatic test, the hose should be straight, not coiled or in a kinked position. Water is the usual test medium and, following the test, the hose may be flushed with alcohol to remove traces of moisture. A regular schedule for testing should be followed and inspection records maintained.

SAFETY WARNING: Before conducting any pressure tests on hose, provisions must be made to ensure the safety of the personnel performing the tests and to prevent any possible damage to property. Only trained personnel using proper tools and procedures should conduct any pressure tests

1. Air or any other compressible gas must never be used as the test media because of the explosive action of the hose should a failure occur. Such a failure might result in possible damage to property and serious bodily injury.
2. Air should be removed from the hose by bleeding it through an outlet valve while the hose is being filled with the test medium.
3. Hose to be pressure tested must be restrained by placing steel rods or straps close to each end and at approximate 10-foot (3m) intervals along its length to keep the hose from "whipping" if failure occurs; the steel rods or straps are to be anchored firmly to the test structure but in such a manner that they do not contact the hose which must be free to move.
4. The outlet end of the hose is to be bulwarked so that a blown-out fitting will be stopped.

Air & Multipurpose

General Purpose
Heavy Duty
Push-on

Chemical Transfer

Cleaning Equipment

Food

Transfer
Washdown

Marine

Material Handling

Abrasives
Bulk Transfer
Cement & Concrete

Mining

Petroleum

Aircraft Fueling
Dispensing
Dock
Transfer

Spray

Steam

Vacuum

LPG Delivery

Water

Discharge
Suction & Discharge
Washdown

Welding

Coupling Systems

Equipment

Appendix

General Information

Care, Maintenance and Storage (continued)

Air & Multipurpose

General Purpose
Heavy Duty
Push-on

Chemical Transfer

Cleaning Equipment

Food
Transfer
Washdown

Marine

Material Handling

Abrasives
Bulk Transfer
Cement & Concrete

Mining

Petroleum

Aircraft Fueling
Dispensing
Dock
Transfer

Spray

Steam

Vacuum

LPG Delivery

Water

Discharge
Suction & Discharge
Washdown

Welding

Coupling Systems

Equipment

Appendix

- Provisions must be made to protect testing personnel from the forces of the pressure media if a failure occurs.
- Testing personnel must never stand in front of or in back of the ends of a hose being pressure tested.
- When liquids such as gasoline, oil, solvent or other hazardous fluids are used as the test fluid, precautions must be taken to protect against fire or other damage should a hose fail and the test liquid be sprayed over the surrounding area.

The Rubber Manufacturers Association (RMA) has published separately a series of Hose Technical Information bulletins describing Maintenance, Testing and Inspection recommendations. Reference should be made to the current RMA Catalog of Publications to determine the availability of the latest edition. Bulletins published as of January 2003 include the following:

Publication No.

IP 11-1- Steam Hose
IP 11-2- Anhydrous Ammonia Hose
IP 11-4- Oil Suction and Discharge Hose
IP 11-5- Welding Hose
IP 11-7- Chemical Hose
IP 11-8- Fuel Dispensing Hose

Storage

Rubber hose products in storage can be affected adversely by temperature, humidity, ozone, sunlight, oils, solvents, corrosive liquids and fumes, insects, rodents and radioactive materials.

The appropriate method for storing hose depends to a great extent on its size (diameter and length), the quantity to be stored and the way in which it is packaged. Hose should not be piled or stacked to such an extent that the weight of the stack creates distortions on the lengths stored at the bottom. Since hose products vary considerably in size, weight and length, it is not practical to establish definite recommendations on this point. Hose having a very light wall will not support as much load as could a hose having a heavier wall or hose having a wire reinforcement. Hose which is shipped in coils or bales should be stored so that

the coils are in a horizontal plane.

Whenever feasible, rubber hose products should be stored in their original shipping containers, especially when such containers are wooden crates or cardboard cartons which provide some protection against the deteriorating effects of oils, solvents and corrosive liquids; shipping containers also afford some protection against ozone and sunlight. Certain rodents and insects will damage rubber hose products, and adequate protection from them should be provided.

Cotton-jacketed hose should be protected against fungal growths if the hose is to be stored for prolonged periods in humidity conditions in excess of 70%.

The ideal temperature for the storage of rubber products ranges from 50°F to 70°F (10°C to 21°C) with a maximum limit of 100°F (38°C). If stored below 32°F (0°C), some rubber products become stiff and would require warming before being placed in service. Rubber products should not be stored near sources of heat, such as radiators, base heaters, etc., nor should they be stored under conditions of high or low humidity.

To avoid the adverse effects of high ozone concentration, rubber hose products should not be stored near electrical equipment that may generate ozone or be stored for any lengthy period in geographical areas of known high ozone concentration. Exposure to direct or reflected sunlight, even through windows, should also be avoided. Uncovered hose should not be stored under fluorescent or mercury lamps which generate light waves harmful to rubber.

Storage areas should be relatively cool and dark, and free of dampness and mildew. Items should be stored on a first-in, first-out basis, since even under the best of conditions, an unusually long shelf life could deteriorate certain rubber products.

*Woven jacket fire hose should be tested in accordance with the service test provisions contained in the current edition of National Fire Protection Association Bulletin No. 1962 - Standard for the Care, Use and Service Testing of Fire Hose.

ContiTech



Contact

ContiTech
NAFTA Headquarters
703 S. Cleveland Massillon Road
Fairlawn, OH 44333-3023 U.S.A.
1-800-235-4632

Canada

1-888-275-4397
FAX 1-888-464-4397

Mexico

1-800-439-7373
FAX 1-800-062-0918

www.contitech.us

ContiTech. Engineering Next Level

As a division of the Continental Group, ContiTech is a recognized innovation and technology leader in natural rubber and plastics. As an industry partner with a firm future ahead of us, we engineer solutions both with and for our customers around the world. Our bespoke solutions are specially tailored to meet the needs of the market. With extensive expertise in materials and processes, we are able to develop cutting-edge technologies while ensuring we make responsible use of resources. We are quick to respond to important technological trends, such as function integration, lightweight engineering and the reduction of complexity, and offer a range of relevant products and services. That way, when you need us, you'll find we're already there.